



Data Storage, Security & Performance

XCubeDAS

| XD5300 Series



Product Highlights

- Latest 12Gb SAS 3.0 technology
- Full range product selections
- Flexible expansion
- Dual-Active controller and high availability design with no single point of failure
- 10 x 12Gb/s SAS wide ports and total 480Gb/s bandwidth
- Up to 24,000MB/s sequential read and 22,000MB/s sequential write throughput, up to 4.2 million sequential IOPS
- Versatile topologies, zoning, and runtime configuration
- Intuitive CubeView DAS central management software
- Complete HBA and RAID controller cards support
- Compatible with VMware vSAN and Microsoft Windows Server 2016
- Green Technology





[P1 / Index](#)

[P2 / Overview](#)

[P2 / Wide Ranging Product Portfolio](#)

[P3 / Dual Active Controller & High Availability Design](#)

[P4 / High Performance & High Throughput](#)

[P5 / Flexible Expansion](#)

[P6 / Versatile Topologies & Flexible Configurations](#)

[P7 / QSAN CubeView Central Management Software](#)

[P8 / Interoperability](#)

[P8 / Wide Compatibility](#)

[P9 / Green Technology](#)

[P10 / Accessories](#)

[P11 / Hardware Specifications](#)

[P12 / Software](#)

XCubeDAS XD5300 Series Overview

QSAN XCubeDAS XD5300 series is a cost-effective DAS (Direct Attached Storage) or JBOD (Just a Bunch Of Disks) for server expansion. It is also a RAID expansion enclosure for QSAN SAN (Storage Area Network) XCubeSAN series.

Wide Ranging Product Portfolio

The XD5300 series features a wide range of form factors including a 24-bay, 4U 3.5" LFF chassis (XD5324 model), 3U 16-bay (XD5316 model), 2U 12-bay (XD5312 model), and a 26-bay, 2U 2.5" SFF chassis (XD5326 model). This allows more deployment flexibility to meet users' budgets and rack density limitations.



XD5324 model



XD5316 model



XD5312 model



XD5326 model

QSAN XD5326 model (2.5" 2U 26-bay) is the industry's first high density all flash/low power DAS storage. It has two more storage bays (around 8% more capacity) than the popular 2U 24-bay products available on the market. This can further lower the cost per TB, minimize IT rack space, and generate smaller and greener footprint.

Dual Active Controller & High Availability Design

The XCubeDAS XD5300 DAS systems offer fully redundant components for all major functions, including dual controllers, power supplies, fan modules, host ports, and expansion ports. Besides hot swappable components, the XD5300 firmware is able to update firmware without any system down time and balancing I/O loading through multiple paths and dual controllers.

• Redundant & Hot-pluggable Components

The XD5300 series features a fully modularized, cable-less architecture. In addition to Dual-Active controllers, all critical components inside the unit such as power supply modules, fan modules, and hot pluggable to provide fault tolerance capabilities.

In case of any component failure, the system will notify the administrator immediately; an alarm will go off and the central management software will clearly indicate which component is at risk or has failed. The IT manager can then simply unplug the failed component and replace it without affecting uptime.

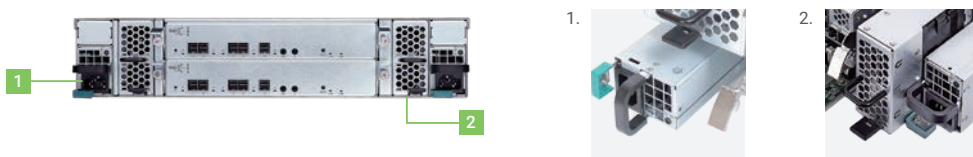

• Multipath Storage Access

To provide a fault-tolerance and load-balancing storage system, all data paths in the system from hard drives, backplane, expander physical links, and front-end ports to servers have to be both hardware redundant and well-defined firmware redundancy protection. The XCubeDAS XD5300 series are built with fully redundancy paths and protection to every data I/O and compatible with Microsoft Windows MPIO, Clustering, and Linux Multipathing. The multipath software layers in the operating systems can leverage the redundant paths to provide performance-enhancing, e.g., load-balancing, round-robin, failover, and dynamic reconfiguration.

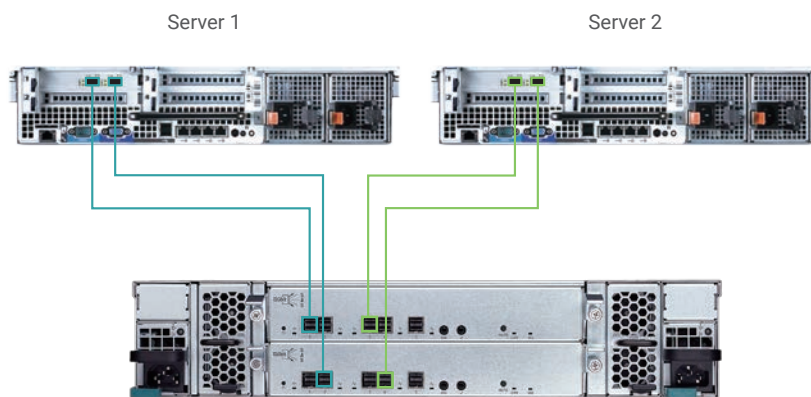

MPIO High Availability Topology for Clustered Servers

High Performance & High Throughput

The XD5300 solutions set a new storage standard for direct-attached storage. The series provides a smart and elastic runtime configuration of the 10 x 12Gb/s SAS wide ports support, and allows IT managers fully utilizing the 480Gb/s data bandwidth per system for various applications.

The optimized 12Gb/s SAS storage system combined with QSAN's best efficient firmware, well-deployed hardware layout, guaranteed full channel bandwidth to each 12Gb/s SAS port, and central management software, enables XCubeDAS XD5300 to deliver 24,000MB/s¹ sequential read and 20,000MB/s¹ sequential write in throughput and over end-to-end 4.2 million² sequential IOPS.

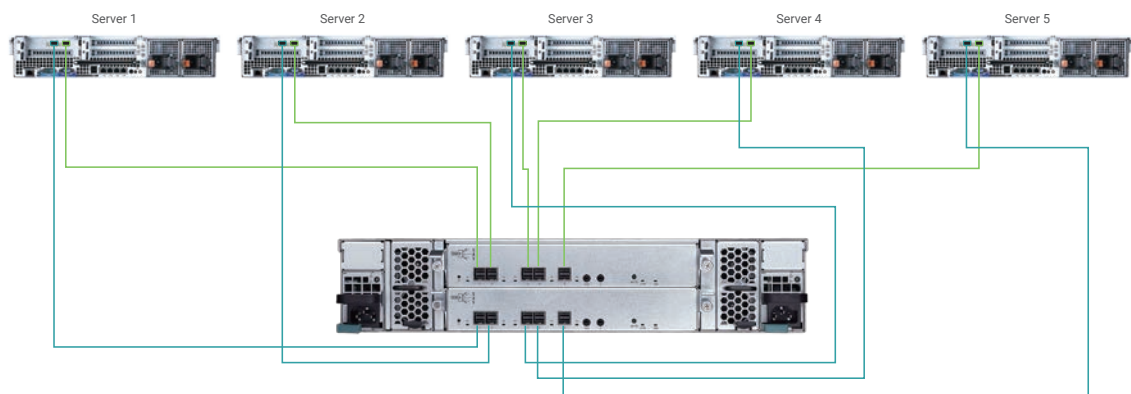

Offering ultra high throughput and ultra wide range data bandwidth, 10 x runtime configurable 12Gb/s SAS wide ports, and multiple enclosure options, this series is ideal for video editing, high performance computing, cloud storage, streaming, broadcasting, virtualization, and datacenters.

• 12Gb SAS Controller

12Gb SAS 3.0 is the latest and fastest drive interface available. It doubles the data transfer rate of SAS 2.0 (6Gb), while remaining backward compatible with 6Gb SAS 2.0 drives. The benefit is that you have the flexibility to purchase less expensive 6Gb SAS drives for initial installation or leverage investment of your existing 6Gb SAS drives and have a peace of mind knowing you can migrate to 12Gb SAS 3.0 by purchasing only new drives.



12Gb SAS is backward compatible with 6Gb SAS

¹ Benchmarked by 5 servers with Broadcom (LSI) 12Gb/s SAS HBA, Iometer utility, 1MB I/O size, non-cache hit, 32 queue depths, and 24 x 12Gb SAS SSD drives.
² The number is derived from sequential, non-cache hit, small I/O size (4KB) using 24 x 12Gb SAS SSD drives.

Flexible Expansion

The XD5300 series expansion enclosures offer flexible drive configurations. For LFF chassis of XD5324/XD5316/XD5312 models, they support mix and match 3.5"/2.5" SAS, NL-SAS HDD, and 2.5" SAS, SATA³ SSD. For SFF chassis of XD5326 models, it supports 2.5" SAS, NL-SAS HDD, and 2.5" SAS, SATA³ SSD.

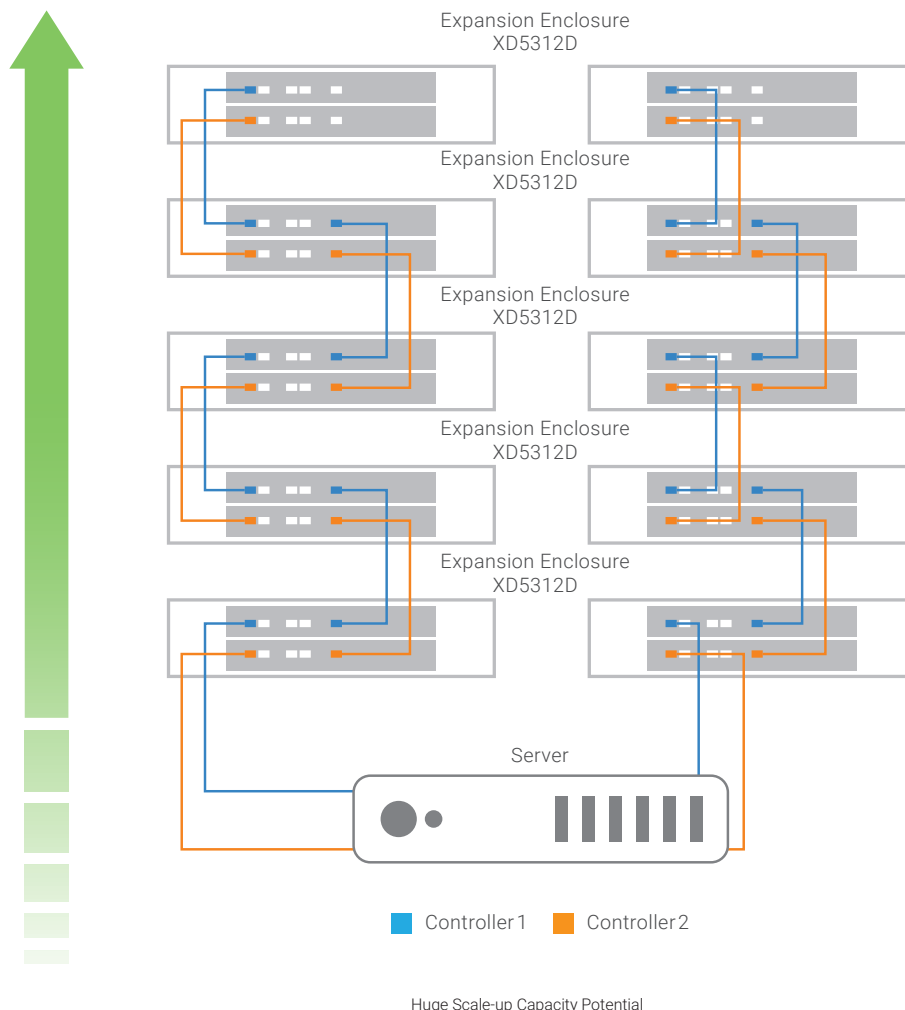

For the maximum number of disk drives support, it depends on the capability of the HBAs and RAID cards⁴. For the expansion of QSAN XCubeSAN series SAN storage, it supports up to ten of mixing XD5300 series for expansion and allows scaling up to 286 disk drives (including SAN storage).

³ 6Gb MUX board needed for 2.5" SATA drives in dual controller system.

⁴ The HBAs and RAID controller cards also specify the maximum number of drive/device support. Broadcom (LSI) 12Gb/s SAS HBA supports up to 1,024 drives/devices, Broadcom (LSI) 12Gb/s SAS RAID controller card up to 240 drives/devices, and ATTO 12Gb/s SAS HBA supports up to 2,048 drives.

Versatile Topologies & Flexible Configurations

The XD5300 features all 12Gb/s SAS topologies and permutations of all host and expansion port configurations. The XD5300 series supports all 12Gb/s SAS topologies, including Cascade, Reverse, and Tree. The XD5300 series can be deployed freely to fit various connections to the host servers. With up to 10 x 12Gb/s SAS ports support per system, this feature is crucial for users to plan a well-defined resource arrangement to achieve highly utilized performance and capacity of the XD5300 system.

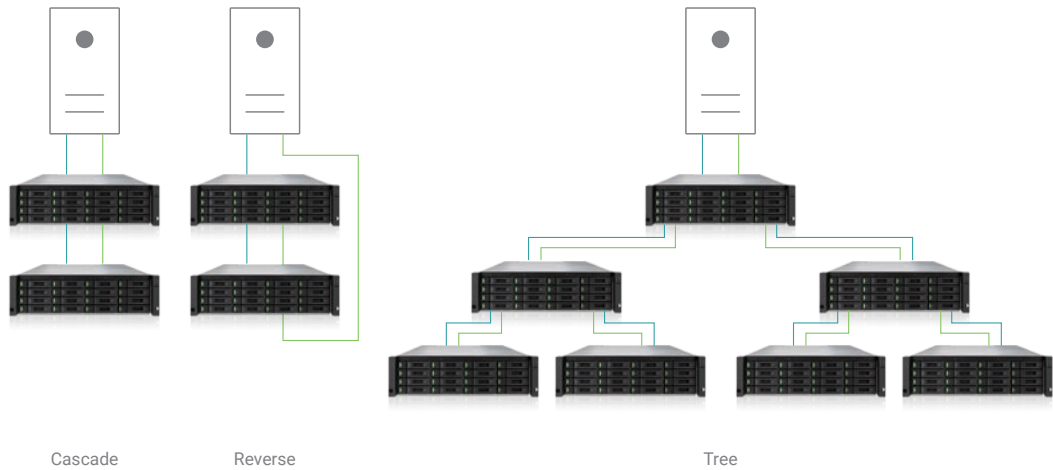

· Zoning

User can select specific group of disk slots and define a zone for it. There can be up to 5 zones per system. Each zone can be assigned to at least 1 x 12Gb/s SAS port. The zoning feature provides better security control even in the direct-attached system scenario. User can use different zones for multiple host servers that connect to the same DAS systems and still have different access control for different zones.

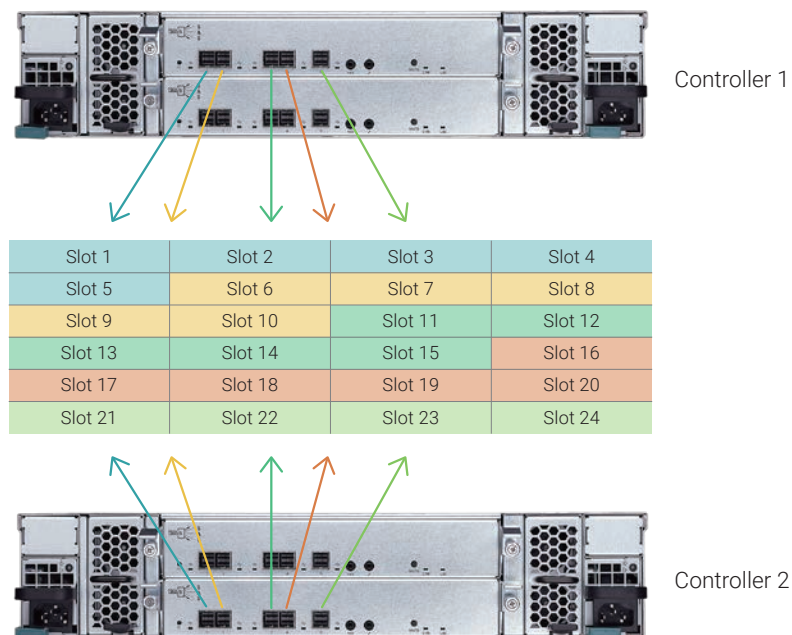

Runtime Configuration

The XD5300 controller's host and expansion ports can be configured and changed IN / OUT⁵ during runtime for different applications and environment requirements. The setting is effective immediately without rebooting the system. The 5 IN, 4 IN / 1 OUT, or 3 IN / 2 OUT configurations displayed below are recommended for better performance utilization.

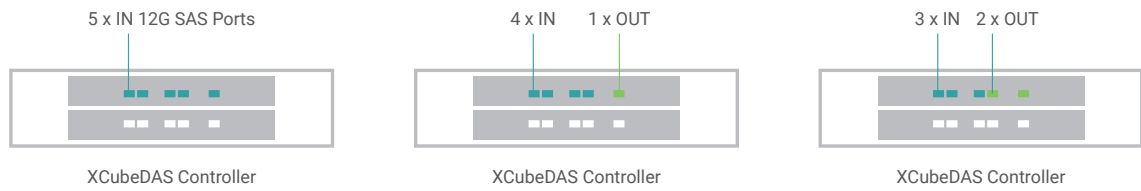

QSAN CubeView Central Management Software

The CubeView CMS (Central Management Software) can monitor and manage system log, disk drive status, enclosure, zoning function, firmware update, and history record of system temperature, voltage, and fan speed. The systems also support command line and S.E.S. that allows IT managers completely control of the storage systems and agile configuration of powerful management.

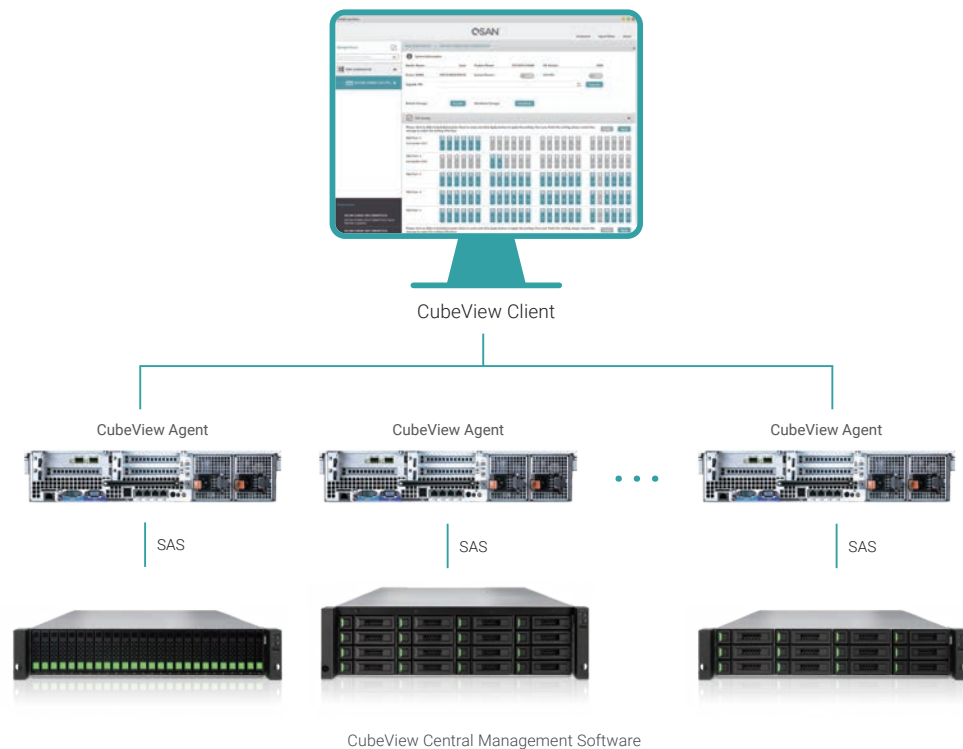

⁵ IN: Connect to Host; OUT: Connect to Expansion

Interoperability

The XD5300 series has high interoperability, it supports host server running the following operating systems and virtualization environments.

- Windows Server 2008, 2008 R2, 2012, 2012 R2, 2016
- SLES (SUSE Linux Enterprise Server) 10, 11, 12
- RHEL (Red Hat Enterprise Linux) 5, 6, 7
- CentOS (Community ENTERprise Operating System) 6, 7
- Solaris 10, 11
- FreeBSD 9, 10
- Mac OS X 10.11 or later
- VMware vSAN
- Citrix
- Windows Hyper-V & Storage Spaces



Wide Compatibility

QSAN's product development and test departments have invested extensive testing resources to verify compatibility with peripherals including HBAs, RAID controller cards, SAS HDDs, and SSDs to make sure there is maximum compatibility with the XD5300 series.

The XD5300 series provides complete compatibility support of HBAs and RAID controller cards⁶.

- Broadcom (LSI) 12Gb/s & 6Gb/s SAS HBA
- Broadcom (LSI) 12Gb/s & 6Gb/s SAS RAID Controller Cards
- ATTO 12Gb/s & 6Gb/s SAS HBA
- ATTO 6Gb/s SAS RAID Controller Cards⁷

In addition, QSAN has qualified the most popular SAS HDDs and SSDs on the market. Our users have the highest level of flexibility to choose from the most advanced HDDs or SSD flash drives and purchase the best cost/performance drives to suit their needs, significantly reducing IT infrastructure investment costs.

Detailed compatibility matrix can be found at QSAN website: <https://qsan.com/rdht4a>

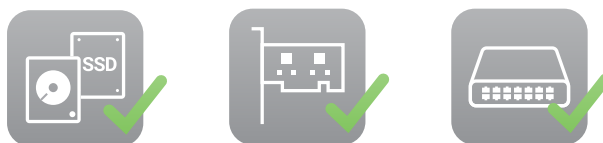

⁶ Not recommend using Microsemi Adaptec HBA & RAID controller cards after QSAN's rigorous compatibility testing.

⁷ ATTO does not have 12Gb/s . SAS RAID controller cards at this stage.

Green Technology

At QSAN we pride ourselves on our commitment to build highly efficient and low carbon footprint devices. To safeguard the earth and our environment, the XD5300 product range uses various green technologies for energy savings and minimization of your carbon footprint.



• 80 PLUS Platinum Power Supply

The XD5300 product family are all equipped with dual redundant 80 PLUS Platinum power supply modules for the ultimate in energy efficiency. At 50% load, these power supplies can provide up to 92% efficiency converting power from AC to DC. This efficiency means that our power supplies can greatly reduce the system's power loss and heat generation.



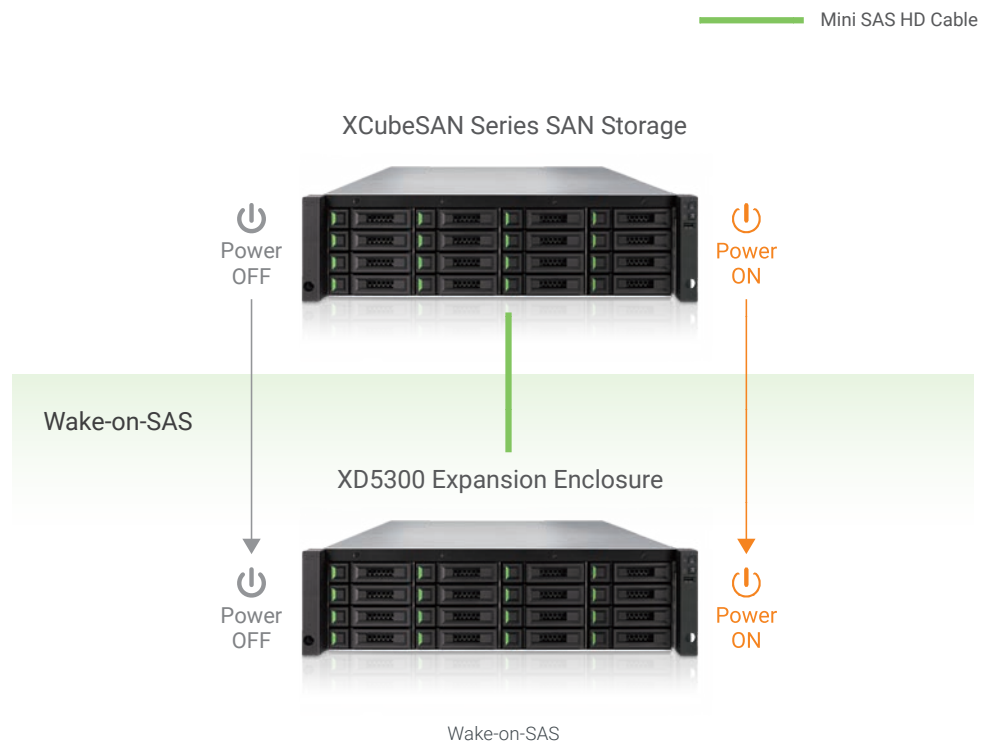

• Wake-on-SAS Technology

For use with XCubeSAN series SAN storage, QSAN's Wake-on-SAS technology allows you to remotely power on/off all cascaded XD5300 expansion enclosures by using QSAN proprietary SAS cables. Wake-on-SAS ensures that expansion enclosures will not run idly, consuming electricity after the SAN storage system is shut down for maintenance or other purposes. Wake-on-SAS can avoid unnecessary electricity waste by allowing your devices to be on only when it is necessary. A further advantage of Wake-on-SAS is that when you turn on the SAN, the expansion enclosures will wake automatically, so there is no need to worry about degrading a volume if you forget to turn them on first.

The following diagram shows that after the XCubeSAN series SAN storage receives the magic packet being sent from the client's computer, it powers on automatically and uses Wake-on-SAS functionality to power-on the attached XD5300 expansion enclosures.



Accessories /

Model Name	Picture	Description	Applied Models
CBL-CNL		Console Cable, Phone-jack, 1 Meter	
CBL-12SW150		SAS 12G Expansion Cable with Wake-on-SAS, SFF-8644 to SFF-8644, 1.5 Meters (This cable is not suitable for connecting HBA or RAID card)	
CBL-12SH150		SAS 12G Expansion Cable, SFF-8644 to SFF-8644, 1.5 Meters	
SLR-RM3640		Slide Rail	
HDT-351		3.5" Disk Drive Tray	XD5324 XD5316 XD5312
HDM-351		SATA 6Gb MUX Board and Bracket for HDT-351 (2.5" SATA drives only)	
HDT-251		2.5" Disk Drive Tray	XD5326
HDM-251		SATA 6Gb MUX Board and Bracket for HDT-251	

Hardware Specifications /



Model Name	XD5324D (Dual) XD5324S (Single)	XD5316D (Dual) XD5316S (Single)	XD5312D (Dual) XD5312S (Single)	XD5326D (Dual) XD5326S (Single)
Form Factor	4U 24-bay, LFF	3U 16-bay, LFF	2U 12-bay, LFF	2U 26-bay, SFF
I/O Controller	Dual-active or Single-upgradable controller			
Host & Expansion Connectivity (per Controller)	5 x 12Gb/s SAS wide ports (SFF-8644)			
Drive Type	Mix & match 3.5" & 2.5" SAS, NL-SAS HDD 2.5" SAS, SATA [®] SSD			2.5" SAS, NL-SAS HDD 2.5" SAS, SATA [®] SSD
HBAs & RAID Cards Support ⁹	Broadcom (LSI) 12Gb/s & 6Gb/s SAS HBAs Broadcom (LSI) 12Gb/s & 6Gb/s SAS RAID Controller Cards ATTO 12Gb/s & 6Gb/s SAS HBAs ATTO 6Gb/s SAS RAID Controller Cards			
Expansion Capabilities	Up to 10 expansion units behind QSAN SAN storage			
SAN Models Support	QSAN XCubeSAN XS5200 & XS3200 series & XS1200 series			
Dimension (H x W x D)	19" Rackmount 170.3 x 438 x 515 mm	19" Rackmount 130.4 x 438 x 515 mm	19" Rackmount 88 x 438 x 515 mm	19" Rackmount 88 x 438 x 491 mm
Power Supply	770W/850W 1+1 redundant 80 PLUS Platinum			
Fan Module	2 x hot pluggable/redundant fan modules			

Warranty

Warranty	System : 3 years
Regulatory	CE, FCC, BSMI, VCCI, KCC

Operating Environment

Temperature	Operating temperature : 0 to 40°C Shipping temperature : -10°C to 50°C
Relative Humidity	Operating relative humidity : 20% to 80% non-condensing Non-operating relative humidity : 10% to 90%

⁸ 6Gb MUX board needed for 2.5" SATA drives in dual controller system.

⁹ The HBAs and RAID controller cards also specify the maximum number of drive/device support. Broadcom (LSI) 12Gb/s SAS HBA supports up to 1,024 drives/devices, Broadcom (LSI) 12Gb/s SAS RAID controller card up to 240 drives/devices, and ATTO 12Gb/s SAS HBA supports up to 2,048 drives.

Software /

Easy Management

- Intuitive CubeView central management software
- S.E.S. support
- CLI (Command Line Interface) support

Host & Expansion Port Configuration

- Automatic configuration
- Recommended configuration
 - 5 IN
 - 4 IN 1 OUT
 - 3 IN 2 OUT

Typologies Support

- Cascade
- Reverse
- Tree

Security

- Zoning

Green & Energy Efficiency

- 80 PLUS Platinum power supply
- Wake-on-SAS to turn on or wake up the system only when necessary with QSAN XCubeSAN series

Host Operating Systems Support

- Windows Server 2008, 2008 R2, 2012, 2012 R2, 2016
- SLES 10, 11, 12
- RHEL 5, 6, 7
- CentOS 6, 7
- Solaris 10, 11
- FreeBSD 9, 10
- Mac OS X 10.11 or later

Software-Defined Storage & Hyper-Converged Solution Support

- VMware vSAN
- Microsoft Windows Server Storage Spaces



QSAN Technology, Inc. | Learn more by visiting www.qsan.com

Address : 4F., No.103, RuiHu Street, NeiHu District, Taipei, Taiwan 114 Email : sales@qsan.com Telephone : +886-2-7720-2118 Fax : +886-2-7720-0295

©Copyright 2017 QSAN Technology, Inc. All Rights Reserved. XCubeDAS and XCubeSAN are trademarks of QSAN Technology, Inc.
All other trademarks are the property of their respective owners. Product features, specifications, and appearance are subject to change without notice.
December 2018