



"focus differently"

# USER MANUAL

Version 2.0.0

Xentino VDSL2 Ethernet Extender

*Models : VX100*

## **Copyright Notice**

Copyright © 2018 Xentino Technologies Corp. All rights reserved. No part of this document may be copied, reproduced, or transmitted by any means, for any purpose without prior written permission.

## **Disclaimer**

We shall not be liable for technical or editorial errors or omissions contained herein; nor for incidental or consequential damages resulting from furnishing this material, or the performance or use of this product. We reserve the right to change the product specification without notice. Information in this document may change without notice.

## **Trademarks**

Microsoft Win98, Windows 2000, WinXP, Win Vista and Win7 are registered trademarks of Microsoft Corporation.

Xentino are registered trademarks of Xentino Technologies Corporation.

General: All other brand and product names mentioned herein may be registered trademarks of their respective owners. Customers should ensure that their use of this product does not infringe upon any patent rights. Trademarks mentioned in this publication are used for identification purposes only and are properties of their respective companies.

# Table of Contents

Chapter 1	Introduction	4
1.1	Features	4
1.2	Specification	5
1.3	Applications	6
Chapter 2	Hardware Installation	7
2.1	Front Panel	7
2.2	Rear Panel	1
2.3	Installation	2
Appendix I		10
Appendix II		12
LIMITED WARRANTY		13

# Chapter 1 Introduction



**VX100 VDSL2 Ethernet Extender** is a high-speed Ethernet Extender with one Ethernet port (RJ-45 connector) and one VDSL port (RJ-45 connector). It is a bridge mode modem, well accommodating VDSL2 (Very-high-data-rate Digital Subscriber Loop) technology to extend Ethernet service over single-pair phone line. It is compliant to ITU-T G.993.2 standard and supports VDSL2 30a profile that features 100Mbps of symmetric data rate over the existing copper wires. Supporting both symmetric and asymmetric transmission, it can reach up to 100/100 Mbps bandwidth (line rate) within 300M or 10/10 Mbps (line rate) for 1 Km long range connections. By providing ultra-high speed, the VDSL2 **VX100** Ethernet Extender makes your telephone line achieve its best performance than before. It has the advantage of minimum installation time (simply as plug-n-play) and minimum expense by allowing video streaming and data to share the same telephone pair without interference.

**VX100** VDSL2 Ethernet Extender delivers everything needed to quickly deploy a high-speed IP-based network for providing high-speed Internet access, video-on demand services and voice services. The resulting compact, cost-effective form factor offers Systems Integrators, small business owners an attractive Long Reach Ethernet solution.

## 1.1 Features

- Cost effective bridge function to connect two Ethernet LAN
- Support flow control on Fast Ethernet port via PAUSE frame or Back Pressure
- IEEE 802.1Q VLAN tag transparent
- Easy installation via simple plug-and-play
- Selectable CPE and CO mode via DIP switch:
  - Two working modes are built in the same unit, which keep the flexibility of installation and easy provision of service but lower inventory of service provider
- Selectable VDSL2 profile mode (17a or 30a):
  - Support up to VDSL2 30a profile to ensure high data rate.
- Selectable target band plan:
  - Symmetric: Support the band plan G.997 and provide the symmetric transmission on both downstream and upstream.
  - Asymmetric: Provides highest line rate in short range in asymmetric mode.
- Selectable target SNR margin
- Compatible with the **D24M/D08M** DSLAM & third party DSLAM.
- Compatible with the 2U 19-inch, 17-slot chassis.

## 1.2 Specification

- **4-position DIP Switch**
  - Selectable CO or CPE mode
  - Selectable 30a or 17a (VDSL2 Profile)
  - Selectable Band plan (Symmetric or Asymmetric)
  - Selectable target SNR margin (6dB or 9dB)
- **LED:**
  - LAN: ACT/LNK, 10/100Mbps, Half/Full Duplex
  - VDSL: Power On/Off, CO/CPE, Idle/Trained/Link
- **Performance\*** (AWG24 Wire)

### Downstream/ Upstream

17a Profile	
600M	42/46 Mbps
1000M	18/13 Mbps
1500M	12/3 Mbps
2000M	5/2 Mbps
30a Profile	
600M	40/45 Mbps
900M	22/19 Mbps
1200M	16/7 Mbps
1800M	8/2 Mbps
2100M	5/2 Mbps

- **LAN Interface:**
  - RJ-45 connector
  - Complying with IEEE 802.3/802.3u/802.3x
  - 10/100 Base-T Auto-Negotiation, Auto-MDI/MDI-X.
- **VDSL Interface:**
  - RJ-45 connector
  - DMT Encoding
  - Complying with ITU-T G993.1/993.2/G.997.1
  - On-board surge protection
- **Regulatory Compliance**
  - CE
  - FCC Part 15 Class B
  - EN60950
- **Power supply:**
  - DC single 12 Volt over 2.0 mm DC jack; 4.2 Watt maximum.
- **Dimension:** 73.4mm x 96.2mm x 22.8mm

\*The above performance data is for reference only, the actual data rate may vary depending on the quality of the copper wire and environmental factors.

### 1.3 Applications

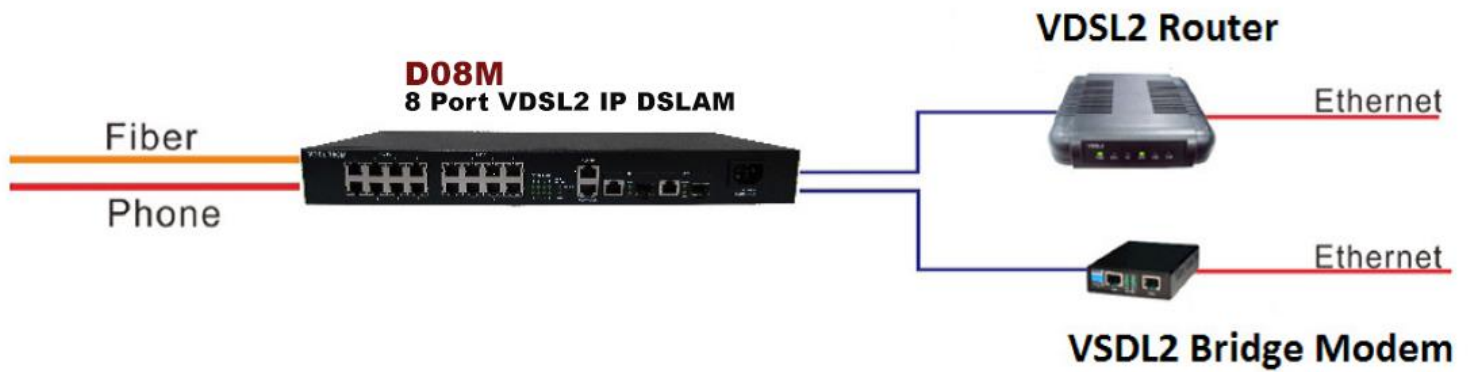

LAN Extender Application

# Chapter 2 Hardware Installation

This chapter shows the front panel and how to install the hardware.

## 2.1 Front Panel

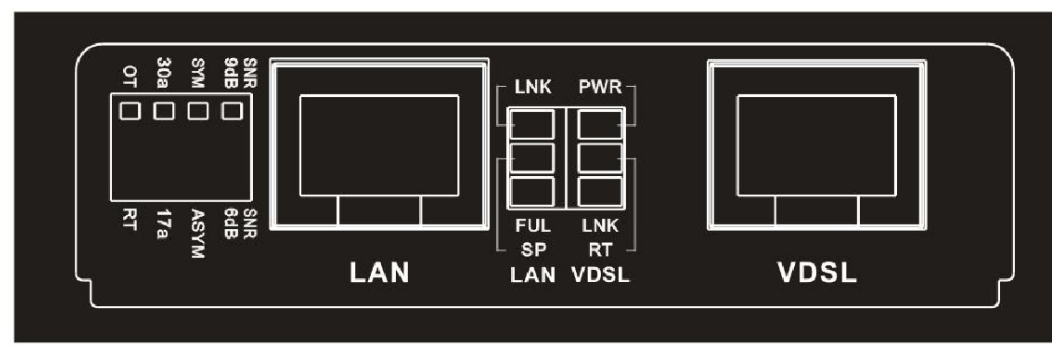

Front panel can be separated into five parts from left to right:

- (1) DIP switch
- (2) RJ-45 connector for Ethernet
- (3) LEDs for Ethernet
- (4) LEDs for VDSL
- (5) RJ-45 connector for VDSL

1. The RJ-45 is designed to connect to the Local Network with the Unshielded Twisted Pair (UTP) cable. The LEDs on top of RJ-45 connector show the status below:
- 2.

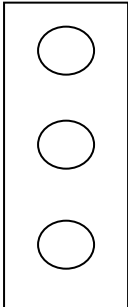
LEDs for LAN	● <b>blinking</b>	● <b>On</b>	○ <b>Off</b>
	Activity	Link UP	Link UP
		100Mbps	10Mbps
		Full Duplex	Half Duplex

LED	Color	Status	Descriptions
PWR(Power LED)	Green	On	Lights to indicate that the VDSL2 bridge had power
	Green	Off	The device is not ready or has malfunctioned.
LNK(Ethernet LED)	Green	On	The device has good Ethernet connection.
	Green	Blinking	The device is sending or receiving data.
	Green	Off	The LAN not connected.
LNK RT(VDSL Link)	Green	On	RT mode.
	Green	Blinking	Handshaking/Transmit & Received data
	Green	Off	The device not ready.
FUL 100(LAN Link)	Green	On	The device is link on 100M Full duplex and ready.
	Green	Blinking	The device is sending or receiving data.
	Green	Off	The device is link on 10M Full duplex and ready.



3. The following table describes the DIP Switches' setting.

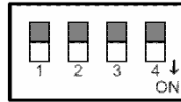

	Pin 1	Pin 2	Pin 3	Pin 4
	Side	Channel	Rate Limit	SNR
Off	OT	30a	Symmetric	9dB
On	RT	17a	Asymmetric	6dB

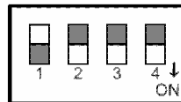

Pin 1: OT, RT switch

**OT:** LAN Extender acts as Central Office (CO) side.

**RT:** LAN Extender acts as Customer Premise Equipment (CPE) side.

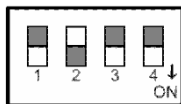

Pin 2: Impulse noise protection

**30a: High Speed Mode.** Provides communication protection for up to 250ms impulse noise with latency less than 6 ms.

**17a: Long Reach Mode.** Direct data transmission with latency less than 1 ms.

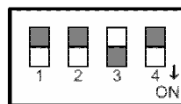

Pin 3: Band Plan

**Symmetric:** Support the band plan G.997 and provide the symmetric transmission on both downstream and upstream.

**Asymmetric:** Provides highest line rate in short range in asymmetric mode.

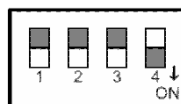

Pin 4: General protection

**9dB:** Better channel noise protection with SNR up to 9 dB

**6dB:** Original channel noise protection with 6 dB SNR.

4. The following table describes the LEDs' function of the product.

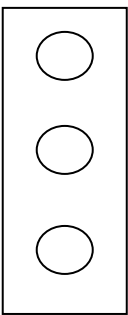
LEDs for VDSL	✱ blinking	● On	○ Off
		Device Power <b>ON</b>	Device Power <b>OFF</b>
		<b>CPE</b> -mode	<b>CO</b> -mode
	<b>Slow: Idle</b> <b>Fast: Training</b>	<b>Linked</b>	<b>Off line</b>

## 2.2 Rear Panel

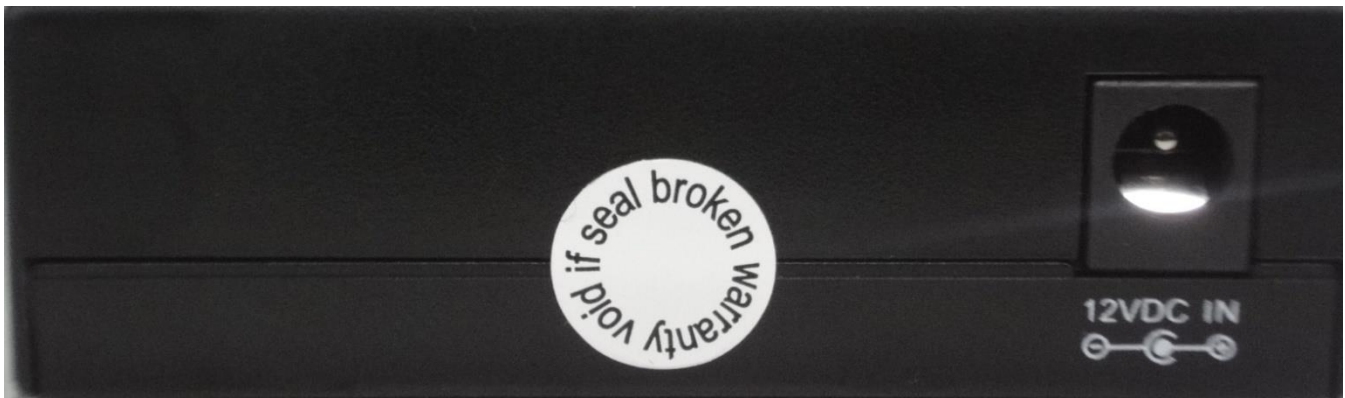

The DC Jack on the rear panel can be connected to power supply adaptor with the DC input.

## 2.3 Installation

Please see the illustration below

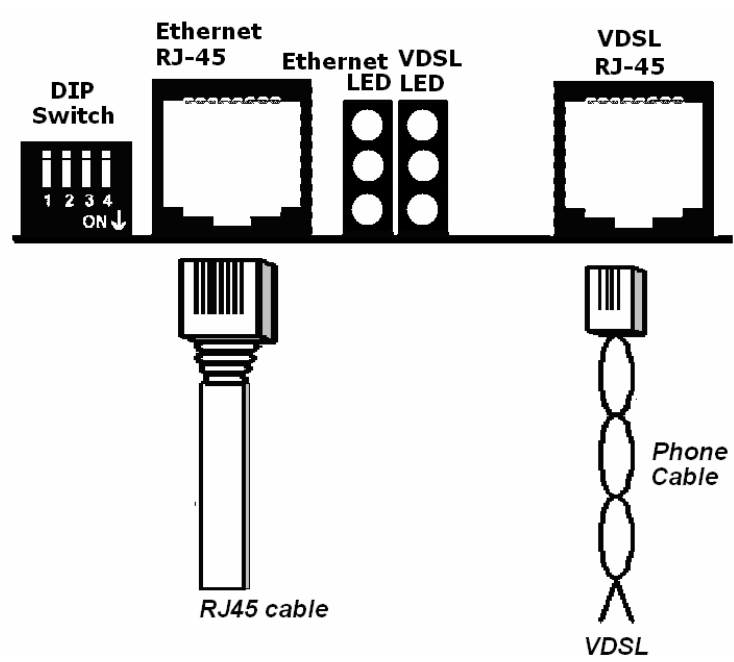

# Appendix I

## Connector Architecture

### Ethernet Port Connector (RJ-45)

The Ethernet Port interface is an 8 position Modular Jack. The table below displays the pin out assignments.

Pin Number	Assignment (MDI-X)	Figure
1	RX+; Receive data +	
2	RX-; Receive data -	
3	TX+; Transmit data +	
4	Not used	
5	Not used	
6	TX-; Transmit Data -	
7	Not used	
8	Not used	

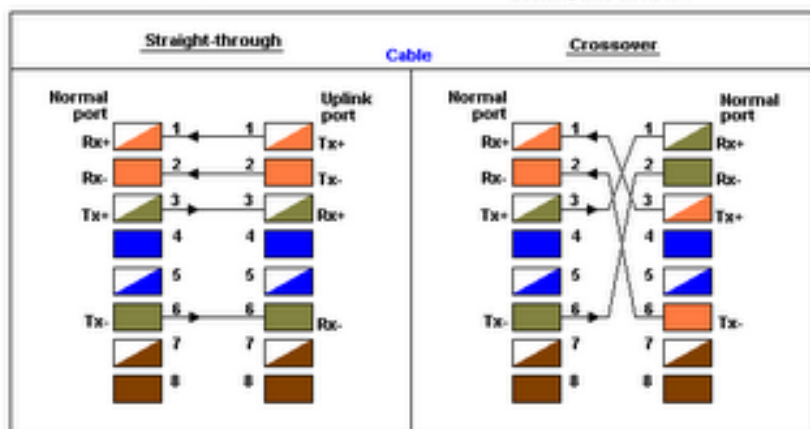
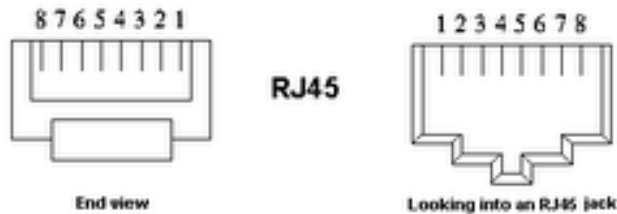

(Atys)

## VDSL Interface Pin Assignments (RJ-45)

The VDSL interface is standard eight-pin modular jack. The table below displays the pin out assignments.

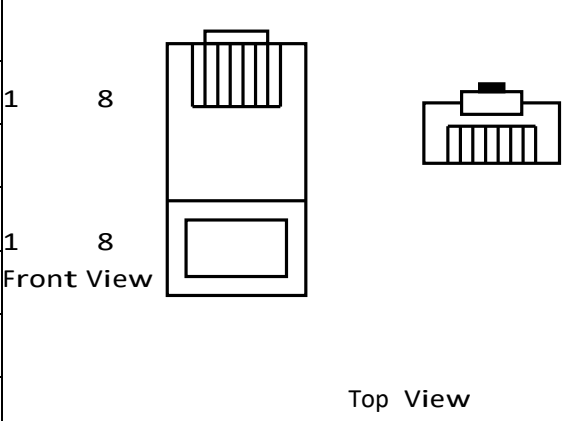
Pin Number	Description	Figure
1	Not used	
2	Not used	
3	Not used	
4	ANALOG Input/Output	
5	ANALOG Input/Output	
6	Not used	
7	Not used	
8	Not used	

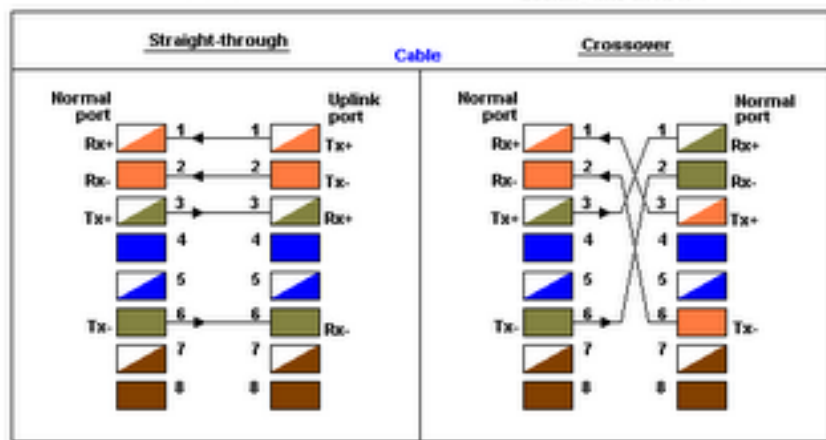
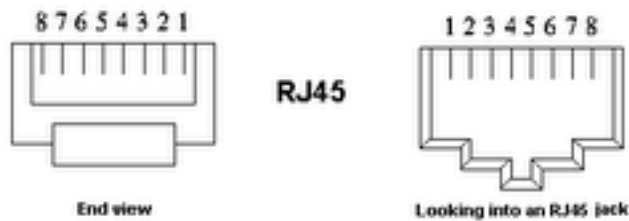

# Appendix II

## Chassis Accessory



There is also the Chassis solution for application on the rack in CO side. The major feature of the Chassis is listed below:

- 2U, 19", 17-Slot rack
- Support 17-slot in one unit
- Power Input: AC: 100 ~240V or DC48: 36 ~ 60V
- Cross flow cooling fan built-in
- **VX100** units are hot swappable

## Specifications

- Power Input: AC : 100 ~240V or DC48 : 36 ~ 60V
- Power Consumption: >60W
- Dimensions: 76 X 212 X 88 mm (D x W x H )
- Weight: 7.9Kg
- Temperature: 0 ~ 50°C (Operating), -10 ~ 70°C (Storage)
- Humidity: 10 ~ 90% non-condensing
- Certification; CE, FCC, RoHS Compliant
- MTBF: 65,000 hrs

# LIMITED WARRANTY

## What the warranty covers:

We warrant its products to be free from defects in material and workmanship during the warranty period. If a product proves to be defective in material or workmanship during the warranty period, we will at its sole option repair or replace the product with a like product with a like product. Replacement product or parts may include remanufactured or refurbished parts or components.

## How long the warranty is effective:

The device is warranted for 1(one) year for all parts and one year for all labor from the date of the first consumer purchase.

## Who the warranty protects:

This warranty is valid only for the first consumer purchaser.

## What the warranty does not cover:

1. Any product, on which the serial number has been defaced, modified or removed.
2. Damage, deterioration or malfunction resulting from:
  - a. Accident, misuse, neglect, fire, water, lightning, or other acts of nature, unauthorized product modification, or failure to follow instructions supplied with the product.
  - b. Repair or attempted repair by anyone not authorized by us.
  - c. Any damage of the product due to shipment.
  - d. Removal or installation of the product.
  - e. Causes external to the product, such as electric power fluctuations or failure. f. Use of supplies or parts not meeting our specifications.
  - g. Normal wears and tears.
  - h. Any other cause that does not relate to a product defect.
3. Removal, installation, and set-up service charges.

## How to get service:

1. For information about receiving service under warranty, contact our Customer Support.
2. To obtain warranted service, you will be required to provide (a) the original dated sales slip, (b) your name, (c) your address (d) a description of the problem and (e) the serial number of the product.
3. Take or ship the product prepaid in the original container to your dealer, and our service center.
4. For additional information, contact your dealer or our Customer Service Center.

## Limitation of implied warranties:

THERE ARE NOWARRANTED, EXPRESSED OR IMPLIED, WHICH EXTEND BEYOND THE DESCRIPTION CONTAINED HEREIN INCLUDING THE IMPLIED WARRANTY OF MERCHANTABILITY AND FITNESS FOR A PARTICULAR PURPOSE.

## Exclusion of damages:

Our LIABILITY IS LIMITED TO THE COST OF REPAIR OR REPLACEMENT OF THE PRODUCT. We SHALL NOT BE LIABLE FOR:

1. DAMAGE TO OTHER PROPERTY CAUSED BY ANY DEFECTS IN THE PRODUCT, DAMAGES BASED UPON INCONVENIENCE, LOSS OF USE OF THE PRODUCT, LOSS OF TIME, LOSS OF PROFITS, LOSS OF BUSINESS OPPORTUNITY, LOSS OF GOODWILL, INTERFERENCE WITH BUSINESS RELATIONSHIPS, OR OTHER COMMERCIAL LOSS, EVEN IF ADVISED OF THE POSSIBILITY OF SUCH DAMAGES.
2. ANY OTHER DAMAGES, WHETHER INCIDENTAL, CONSEQUENTIAL OR OTHERWISE.
3. ANY CLAIM AGAINST THE CUSOMER BY ANY OTHER PARTY.



*"focus differently"*