

DrayTek

Vigor2750 Series High Speed VDSL2 Router



Quick Start Guide

V1.0

Vigor2750 Series High Speed VDSL2 Router Quick Start Guide

Version: 1.0

Firmware Version:V1.4.0_RC2

Date: 12/08/2010

Copyright Information

Copyright Declarations

Copyright 2010 All rights reserved. This publication contains information that is protected by copyright. No part may be reproduced, transmitted, transcribed, stored in a retrieval system, or translated into any language without written permission from the copyright holders.

Trademarks

The following trademarks are used in this document:

- Microsoft is a registered trademark of Microsoft Corp.
- Windows, Windows 95, 98, Me, NT, 2000, XP, Vista and Explorer are trademarks of Microsoft Corp.
- Apple and Mac OS are registered trademarks of Apple Inc.
- Other products may be trademarks or registered trademarks of their respective manufacturers.

Safety Instructions and Approval

Safety Instructions

- Read the installation guide thoroughly before you set up the router.
- The router is a complicated electronic unit that may be repaired only by authorized and qualified personnel. Do not try to open or repair the router yourself.
- Do not place the router in a damp or humid place, e.g. a bathroom.
- Do not stack the routers.
- The router should be used in a sheltered area, within a temperature range of +5 to +40 Celsius.
- Do not expose the router to direct sunlight or other heat sources. The housing and electronic components may be damaged by direct sunlight or heat sources.
- Do not deploy the cable for LAN connection outdoor to prevent electronic shock hazards.
- Keep the package out of reach of children.
- When you want to dispose of the router, please follow local regulations on conservation of the environment.

Warranty

We warrant to the original end user (purchaser) that the router will be free from any defects in workmanship or materials for a period of two (2) years from the date of purchase from the dealer. Please keep your purchase receipt in a safe place as it serves as proof of date of purchase. During the warranty period, and upon proof of purchase, should the product have indications of failure due to faulty workmanship and/or materials, we will, at our discretion, repair or replace the defective products or components, without charge for either parts or labor, to whatever extent we deem necessary to restore the product to proper operating condition. Any replacement will consist of a new or re-manufactured functionally equivalent product of equal value, and will be offered solely at our discretion. This warranty will not apply if the product is modified, misused, tampered with, damaged by an act of God, or subjected to abnormal working conditions. The warranty does not cover the bundled or licensed software of other vendors. Defects which do not significantly affect the usability of the product will not be covered by the warranty. We reserve the right to revise the manual and online documentation and to make changes from time to time in the contents hereof without obligation to notify any person of such revision or changes.

Be a Registered Owner

Web registration is preferred. You can register your Vigor router via <http://www.draytek.com>.

Firmware & Tools Updates

Due to the continuous evolution of DrayTek technology, all routers will be regularly upgraded. Please consult the DrayTek web site for more information on newest firmware, tools and documents.

<http://www.draytek.com>

European Community Declarations

Manufacturer: DrayTek Corp.
Address: No. 26, Fu Shing Road, HuKou Township, HsinChu Industrial Park, Hsin-Chu, Taiwan
303
Product: Vigor2750 Series Router

DrayTek Corp. declares that Vigor2750 Series of routers are in compliance with the following essential requirements and other relevant provisions of R&TTE Directive 1999/5/EEC.

The product conforms to the requirements of Electro-Magnetic Compatibility (EMC) Directive 2004/108/EC by complying with the requirements set forth in EN55022/Class B and EN55024/Class B.

The product conforms to the requirements of Low Voltage (LVD) Directive 2006/95/EC by complying with the requirements set forth in EN60950-1.

Regulatory Information

Federal Communication Commission Interference Statement

This equipment has been tested and found to comply with the limits for a Class B digital device, pursuant to Part 15 of the FCC Rules. These limits are designed to provide reasonable protection against harmful interference in a residential installation. This equipment generates, uses and can radiate radio frequency energy and, if not installed and used in accordance with the instructions, may cause harmful interference to radio communications. However, there is no guarantee that interference will not occur in a particular installation. If this equipment does cause harmful interference to radio or television reception, which can be determined by turning the equipment off and on, the user is encouraged to try to correct the interference by one of the following measures:

- Reorient or relocate the receiving antenna.
- Increase the separation between the equipment and receiver.
- Connect the equipment into an outlet on a circuit different from that to which the receiver is connected.
- Consult the dealer or an experienced radio/TV technician for help.

This device complies with Part 15 of the FCC Rules. Operation is subject to the following two conditions:

- (1) This device may not cause harmful interference, and
- (2) This device may accept any interference received, including interference that may cause undesired operation.

Please visit <http://www.draytek.com/user/AboutRegulatory.php>



This product is designed for DSL, 2.4GHz/5GHz WLAN network throughout the EC region and Switzerland with restrictions in France. Please see the user manual for the applicable networks on your product.

Table of Contents

1. Introduction.....	1
1.1 Panel Explanation	2
1.1.1 For Vigor2750	2
1.1.2 For Vigor2750n	4
1.1.3 For Vigor2750Vn	6
1.2 Package Content.....	8
2. Installing Your Router.....	9
2.1 Hardware Installation.....	9
Stand Installation.....	10
2.2 Printer Installation.....	11
3. Configuring Web Pages	17
3.1 Accessing Web Page	17
3.2 Basic Configuration	18
4. Trouble Shooting	25
4.1 Checking If the Hardware Status Is OK or Not.....	25
4.2 Checking If the Network Connection Settings on Your Computer Is OK or Not	26
4.3 Pinging the Router from Your Computer	28
4.4 Checking If the ISP Settings are OK or Not	29
4.5 Backing to Factory Default Setting If Necessary.....	30
4.6 Contacting Your Dealer	31

1. Introduction

The Vigor2750 series are the routers with high speed in data transmission through DSL port and LAN ports.

With the development of NGN (Next Generation Network), you may recently hear the news about FTTx deployment in your local area or even have already subscribed the unbundling last mile service (e.g. VDSL2) from local ITSP for FTTx. As adopting FTTx, the main question for end users is whether your legacy router could fully utilize its bandwidth or not.

DrayTek launches Vigor 2750 series – High speed router, perfectly complied with VDSL2 environment including Vigor2750, Vigor2750n and Vigor2750Vn for speed-wanted customers. With high throughput performance and secured broadband connectivity provided by Vigor 2750 series, you can simultaneously engage these bandwidth-intensive applications, such as high-definition video streaming, online gaming, and Internet telephony / access.

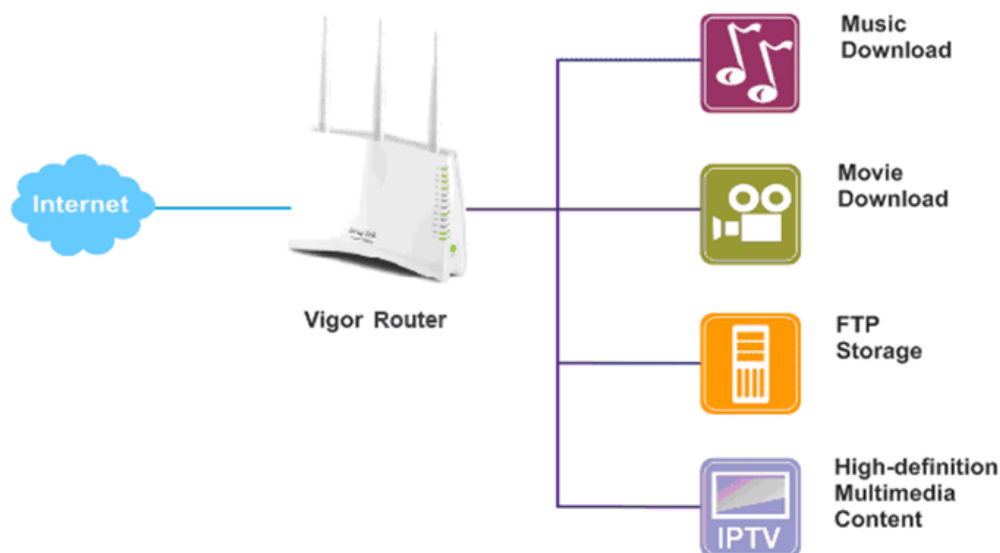

Vigor2750 supports up to 2 VPN tunnels using advanced protocols such as IPSec/PPTP (for remote dial-in only) with AES/3DES for encryption and MD5/SHA-1 for authentication.

Vigor2750 'n' models comply with 802.11n Draft-n standards. They support WEP/WPA/WPA2 encryption and MAC Address Control.

Vigor2750 'V' models provide two analogue phone connectors. It supports multiple SIP registrars with high flexible configuration and call handing options.

In addition, Vigor2750 series supports two USB interfaces for connecting USB printer to share printer or USB storage device for sharing files and 3G backup service. Vigor2750 series provides two-level management to simplify the configuration of network connection. The user mode allows user accessing into WEB interface via simple configuration. However, if users want to have advanced configurations, they can access into WEB interface through admin mode.

1.1 Panel Explanation

1.1.1 For Vigor2750

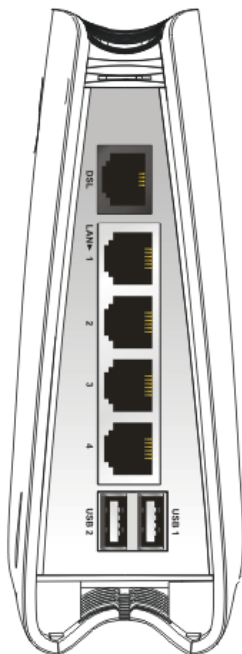
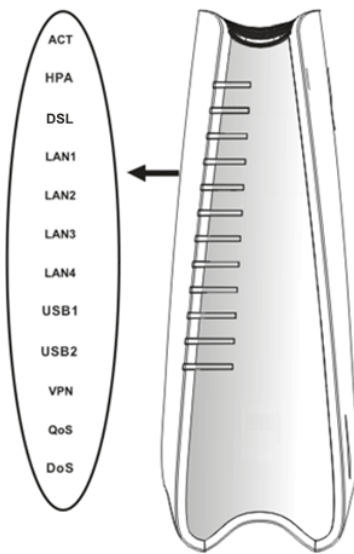

LED	Status	Explanation
ACT (Activity)	Blinking	The router is powered on and running normally.
	Off	The router is powered off.
HPA (Hardware Packet Accelerate)	On	Hardware NAT is enabled.
	Off	Hardware NAT is disabled.
DSL	On	The DSL port is connected.
	Blinking (Slowly)	The router is ready.
	Blinking (Quickly)	The connection is training.
LAN1/2/3/4	On (Green)	The port is connected with 1000Mbps.
	Blinking (Green)	The data is transmitting.
	On (Orange)	The port is connected with 100Mbps.
	Blinking (Orange)	The data is transmitting.
USB1/2	On	A USB device is connected and active.
VPN	On	The VPN tunnel is active.
QoS	On	The QoS function is active.
DoS	On	The DoS/DDoS function is active.

Interface	Description
DSL	Connector for accessing the Internet.
LAN (1-4)	Connectors for local network devices.
USB (1-2)	Connector for USB storage device (Pen Driver/Mobile HD) or printer or 3G backup.

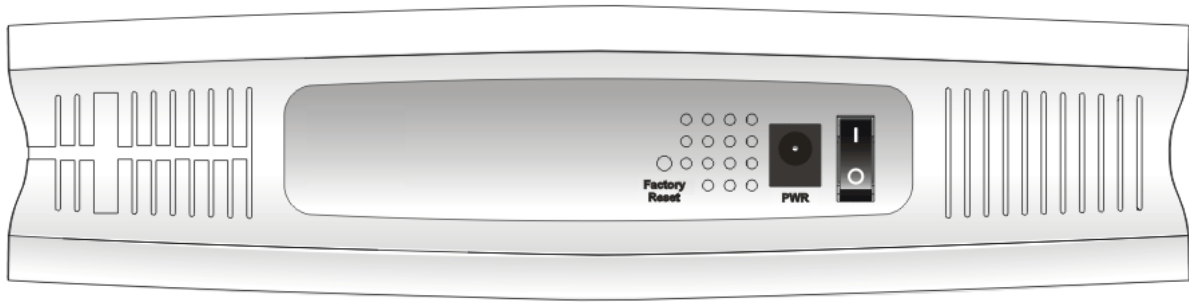

Interface	Description
Factory Reset	Restore the default settings. Usage: Turn on the router (ACT LED is blinking). Press the hole and keep for more than 5 seconds. When you see the ACT LED begins to blink rapidly than usual, release the button. Then the router will restart with the factory default configuration.
PWR	Connector for a power adapter.
I / O	Power switch.

1.1.2 For Vigor2750n

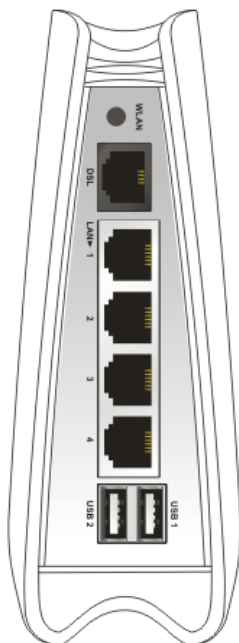
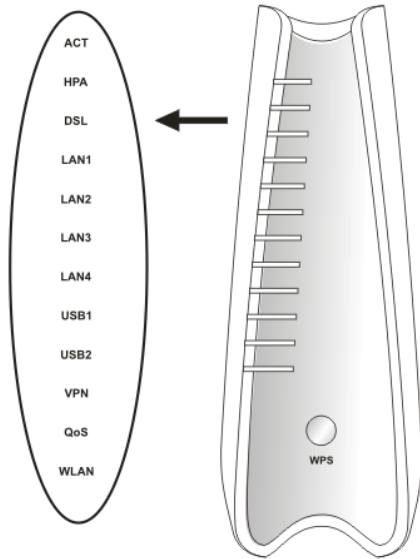

LED	Status	Explanation
ACT (Activity)	Blinking	The router is powered on and running normally.
	Off	The router is powered off.
HPA (Hardware Packet Accelerate)	On	Hardware NAT is enabled.
	Off	Hardware NAT is disabled.
DSL	On	The DSL port is connected.
	Blinking (Slowly)	The router is ready.
	Blinking (Quickly)	The connection is training.
LAN1/2/3/4	On (Green)	The port is connected with 1000Mbps.
	Blinking (Green)	The data is transmitting.
	On (Orange)	The port is connected with 100Mbps.
	Blinking (Orange)	The data is transmitting.
USB1/2	On	A USB device is connected and active.
VPN	On	The VPN tunnel is active.
QoS	On	The QoS function is active.
WLAN	On	Wireless access point is ready.
WPS Button	On	Press this button for 2 seconds to wait for client device making network connection through WPS. When the LED lights up, the WPS connection will be on.
	Off	The WPS is off.

Interface	Description
WLAN	Press the button once to enable (WLAN LED on) or disable (WLAN LED off) wireless connection.
DSL	Connector for accessing the Internet.
LAN (1-4)	Connectors for local network devices.
USB (1-2)	Connector for USB storage device (Pen Driver/Mobile HD) or printer or 3G backup.

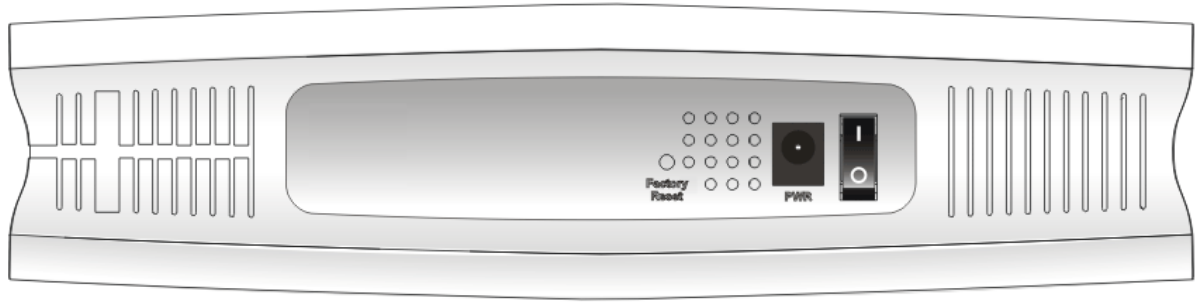

Interface	Description
Factory Reset	Restore the default settings. Usage: Turn on the router (ACT LED is blinking). Press the hole and keep for more than 5 seconds. When you see the ACT LED begins to blink rapidly than usual, release the button. Then the router will restart with the factory default configuration.
PWR	Connector for a power adapter.
I / O	Power switch.

1.1.3 For Vigor2750Vn

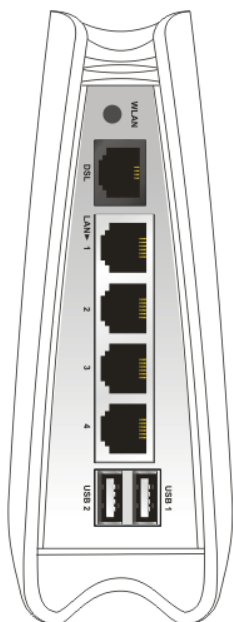
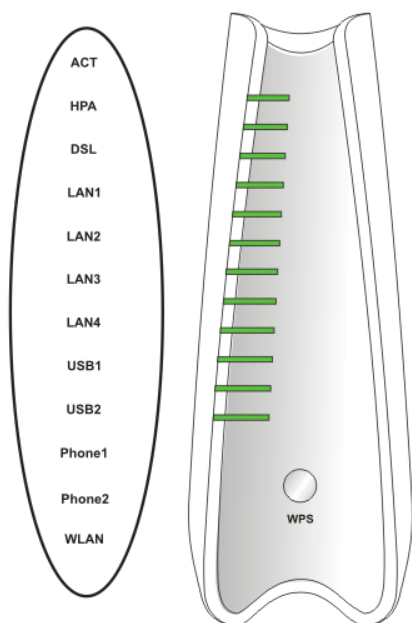

LED	Status	Explanation
ACT (Activity)	Blinking	The router is powered on and running normally.
	Off	The router is powered off.
HPA (Hardware Packet Accelerate)	On	Hardware NAT is enabled.
	Off	Hardware NAT is disabled.
DSL	On	The DSL port is connected.
	Blinking (Slowly)	The router is ready.
	On (Green)	The port is connected with 1000Mbps.
LAN1/2/3/4	On (Green)	The port is connected with 1000Mbps.
	Blinking (Green)	The data is transmitting.
	On (Orange)	The port is connected with 100Mbps.
	Blinking (Orange)	The data is transmitting.
USB1/2	On	A USB device is connected and active.
Phone1/ Phone2	On	The phone connected to this port is off-hook.
	Off	The phone connected to this port is on-hook.
	Blinking	A phone call comes.
WLAN	On	Wireless access point is ready.
WPS Button	On	Press this button for 2 seconds to wait for client device making network connection through WPS. When the LED lights up, the WPS connection will be on.
	Off	The WPS is off.
Interface	Description	
WLAN	Press the button once to enable (WLAN LED on) or disable (WLAN LED off) wireless connection.	
DSL	Connector for accessing the Internet.	
LAN (1-4)	Connectors for local network devices.	
USB (1-2)	Connector for USB storage device (Pen Driver/Mobile HD) or printer or 3G backup.	

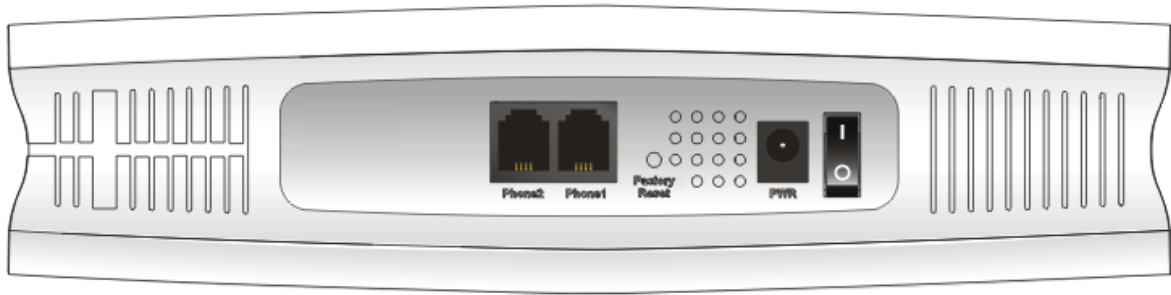

Interface	Description
Phone2/Phone1	Connector of analog phone for VoIP communication.
Factory Reset	Restore the default settings. Usage: Turn on the router (ACT LED is blinking). Press the hole and keep for more than 5 seconds. When you see the ACT LED begins to blink rapidly than usual, release the button. Then the router will restart with the factory default configuration.
PWR	Connector for a power adapter.
I / O	Power switch.

1.2 Package Content

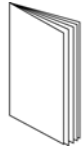

1 Quick Start Guide

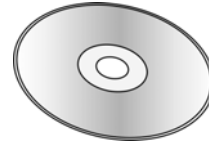

2 CD

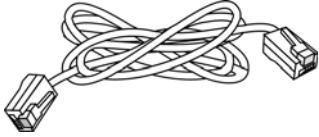

3 RJ-45 Cable (Ethernet)

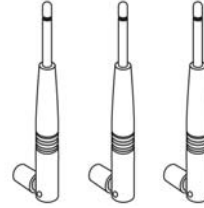

4 Antenna (n models)

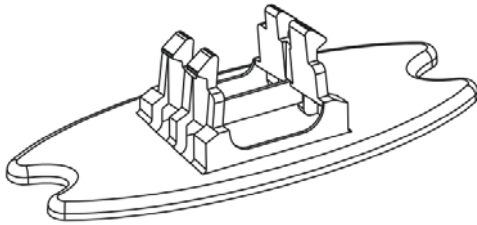

5 Stand

- 6** The type of the power adapter depends on the country that the router will be installed.
* The maximum power consumption is *17-23 Watt*.

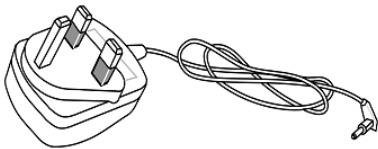

UK-type Power Adapter

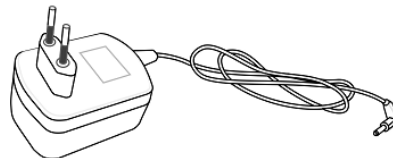

EU-type Power Adapter

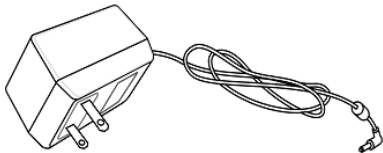

USA/Taiwan-type Power Adapter

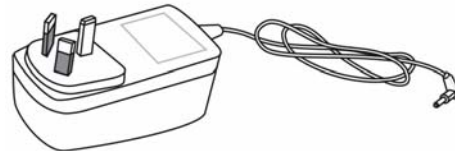

AU/NZ-type Power Adapter

2. Installing Your Router

This section will guide you to install the router through hardware connection and configure the router's settings through web browser.

2.1 Hardware Installation

Before starting to configure the router, you have to connect your devices correctly.

1. Connect the DSL interface to Internet with a VDSL2 line cable.
2. Connect one port of 4-port switch to your computer with a RJ-45 cable. This device allows you to connect 4 PCs directly.
3. Connect Phone port to a conventional analog telephone.
4. Connect detachable antennas to the router for Vigor2750 series (n model).
5. Connect one end of the power cord to the power port of this device. Connect the other end to the wall outlet of electricity.
6. Power on the router.
7. Check the **ACT** and **DSL**, **LAN** LEDs to assure network connection.

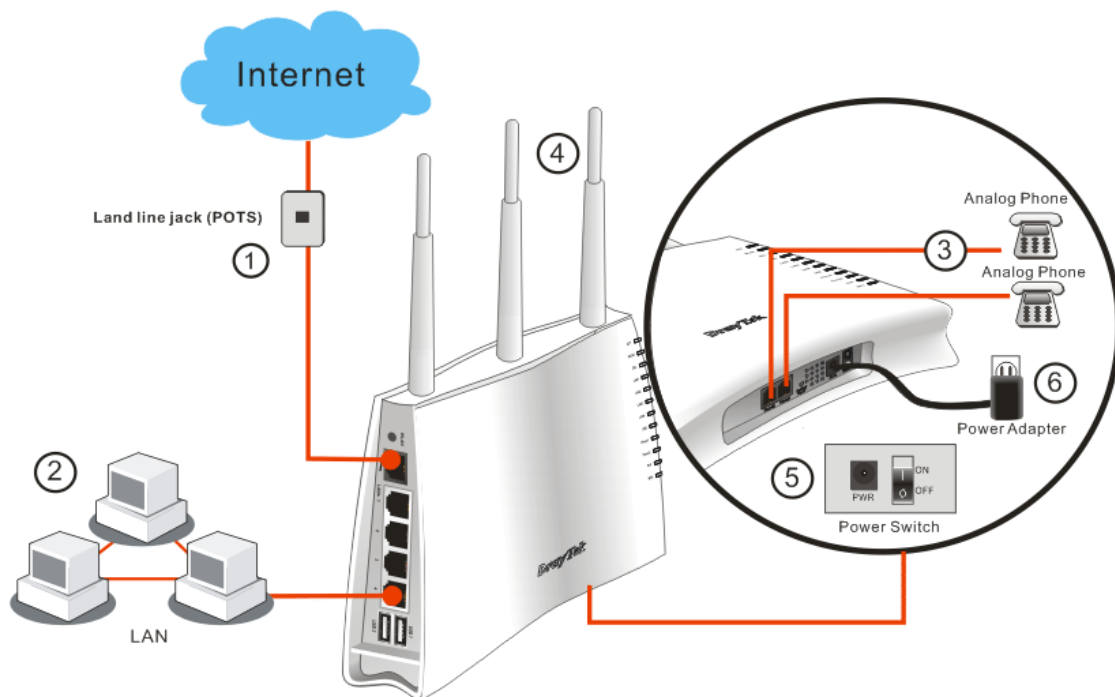

(For the detailed information of LED status, please refer to section 1.1.)

Stand Installation

The Vigor2750 must be placed erectly. Therefore you have to install a stand onto the router to make it standing firmly. Please follow the figures listed below to finish the installation.

①

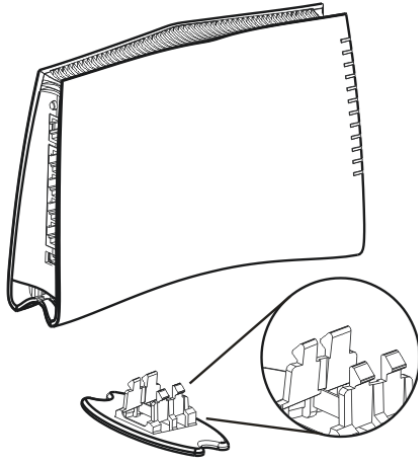

②

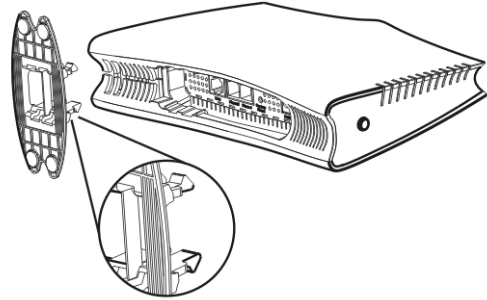

③

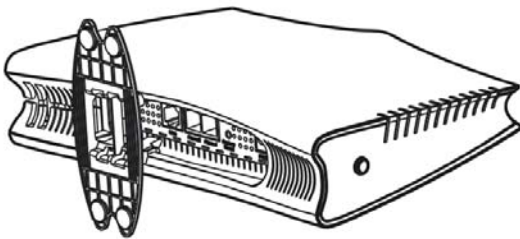

④

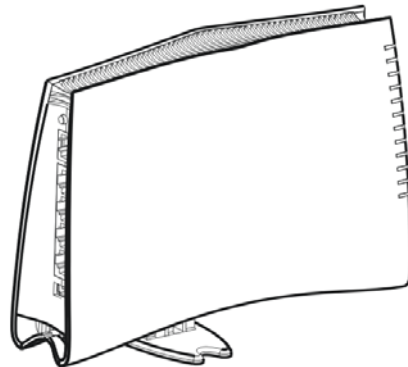

2.2 Printer Installation

You can install a printer onto the router for sharing printing. All the PCs connected this router can print documents via the router. The example provided here is made based on Windows XP/2000. For Windows 98/SE/Vista, please visit www.draytek.com.

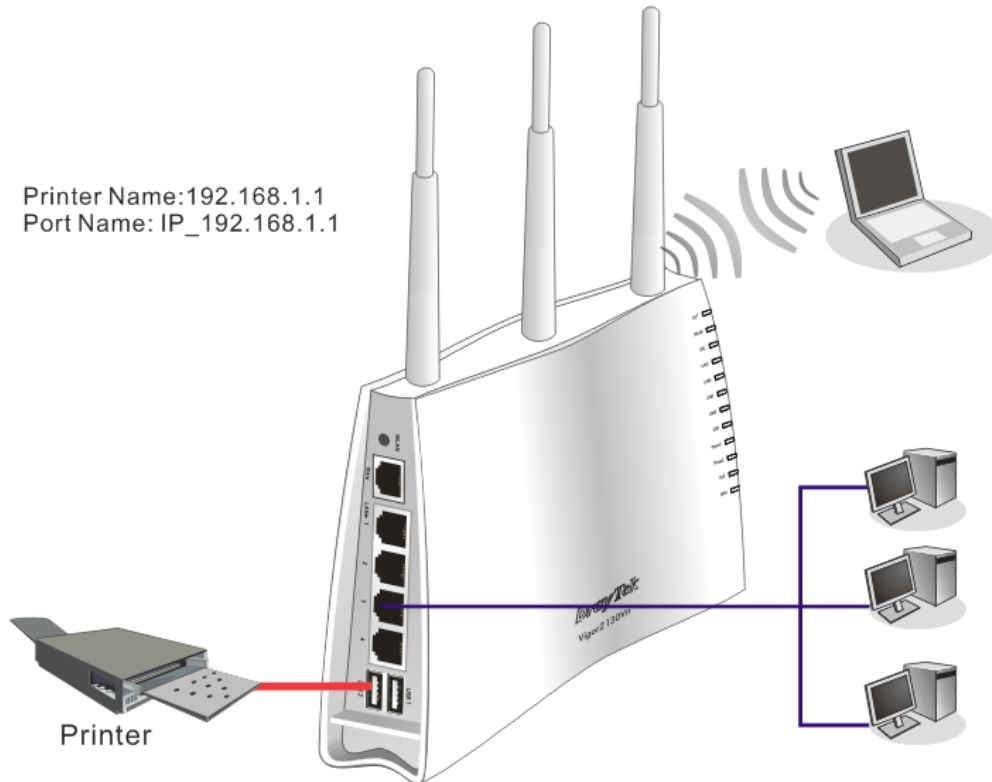

Before using it, please follow the steps below to configure settings for connected computers (or wireless clients).

1. Connect the printer with the router through USB port.
2. Open **Start->Settings-> Printer and Faxes**.

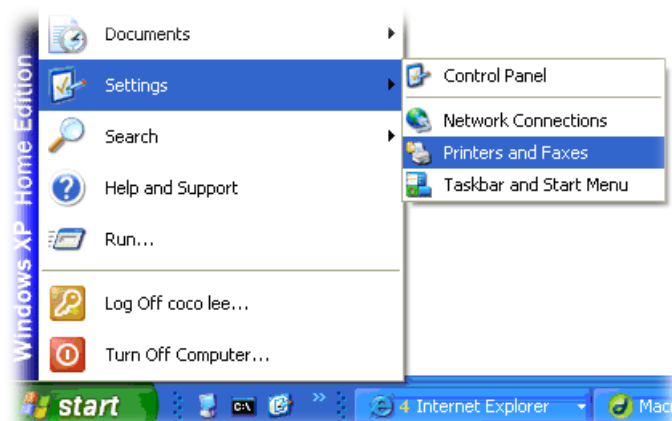

3. Open **File->Add a New Computer**. A welcome dialog will appear. Please click **Next**.

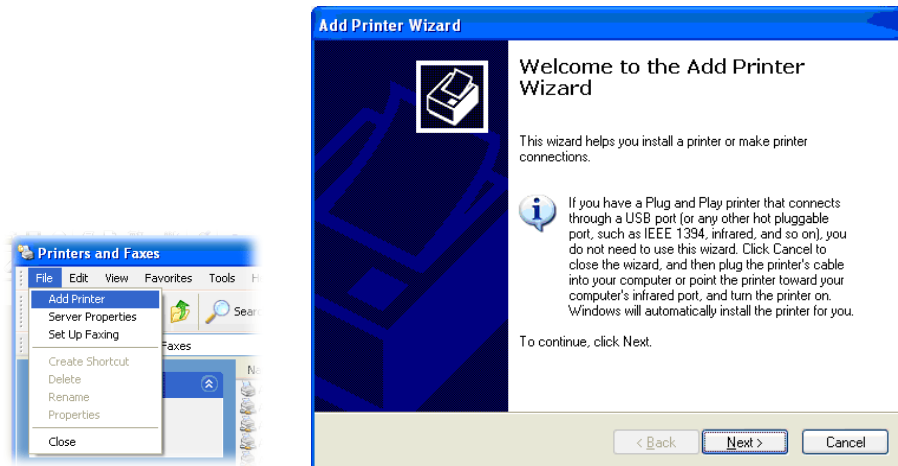

4. Click **Local printer attached to this computer** and click **Next**.



5. In this dialog, choose **Create a new port Type of port** and use the drop down list to select **Standard TCP/IP Port**. Click **Next**.

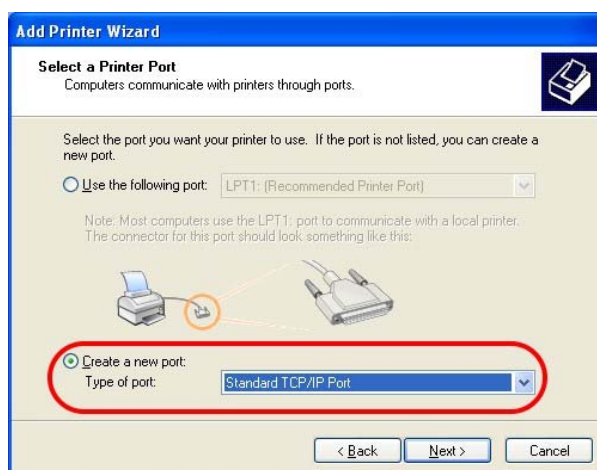

6. In the following dialog, type **192.168.1.1** (router's LAN IP) in the field of **Printer Name or IP Address** and type **IP_192.168.1.1** as the port name. Then, click **Next**.

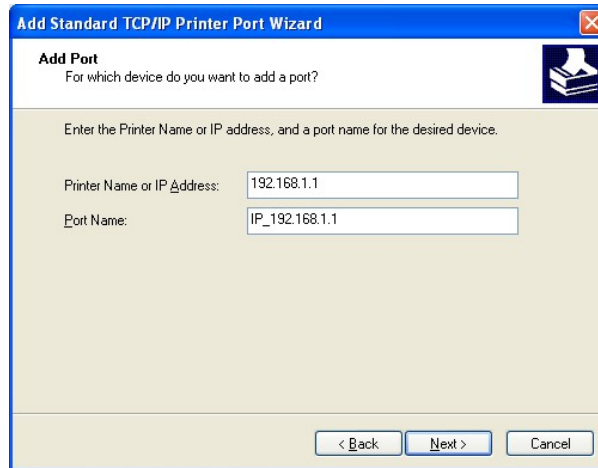

7. Click **Standard** and choose **Generic Network Card**.

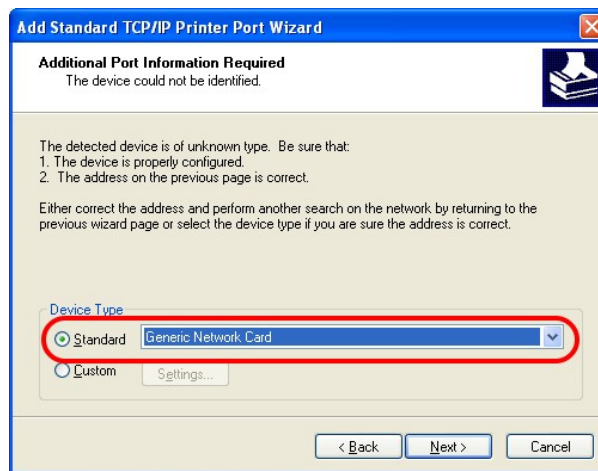

8. Then, in the following dialog, click **Finish**.



- Now, your system will ask you to choose right name of the printer that you installed onto the router. Such step can make correct driver loaded onto your PC. When you finish the selection, click **Next**.

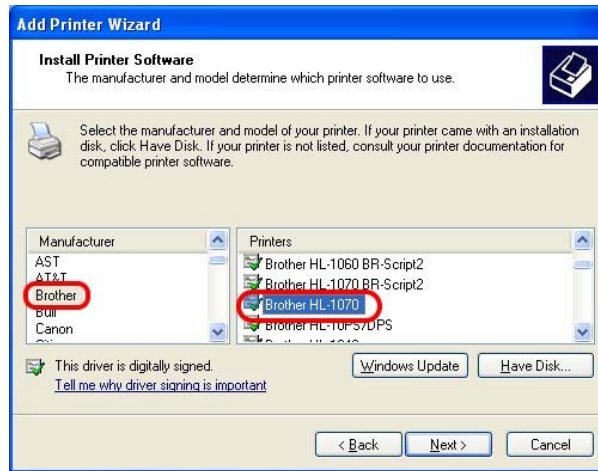

- For the final stage, you need to go back to **Control Panel-> Printers** and edit the property of the new printer you have added.

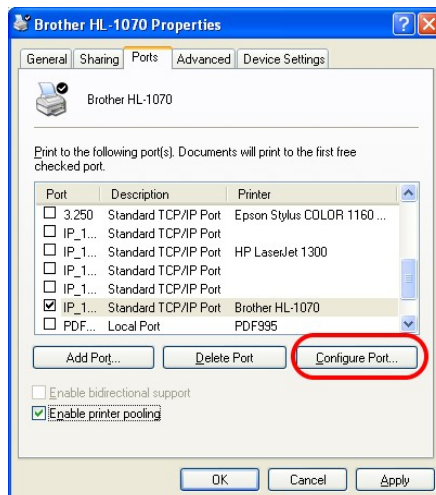

- Select "**LPR**" on Protocol, type **p1** (number 1) as Queue Name. Then click **OK**. Next please refer to the red rectangle for choosing the correct protocol and UPR name.

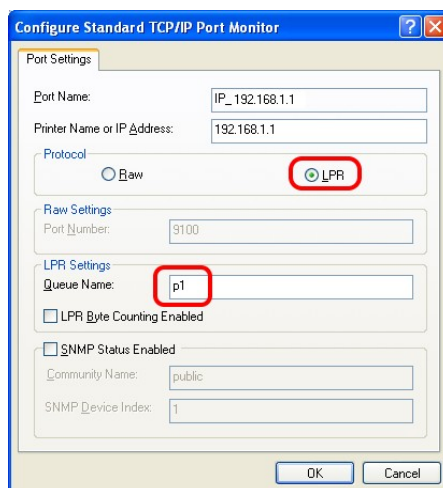

The printer can be used for printing now. Most of the printers with different manufacturers are compatible with vigor router.

Note 1: Some printers with the fax/scanning or other additional functions are not supported. If you do not know whether your printer is supported or not, please visit www.draytek.com to find out the printer list. Open **Support >FAQ**; find out the link of **Printer Server** and click it; then click the **What types of printers are compatible with Vigor router?** link.

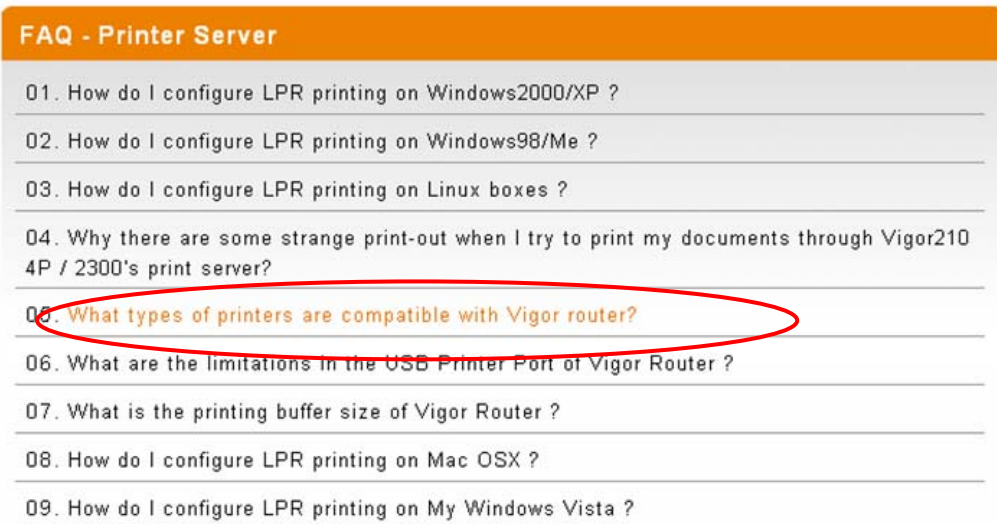
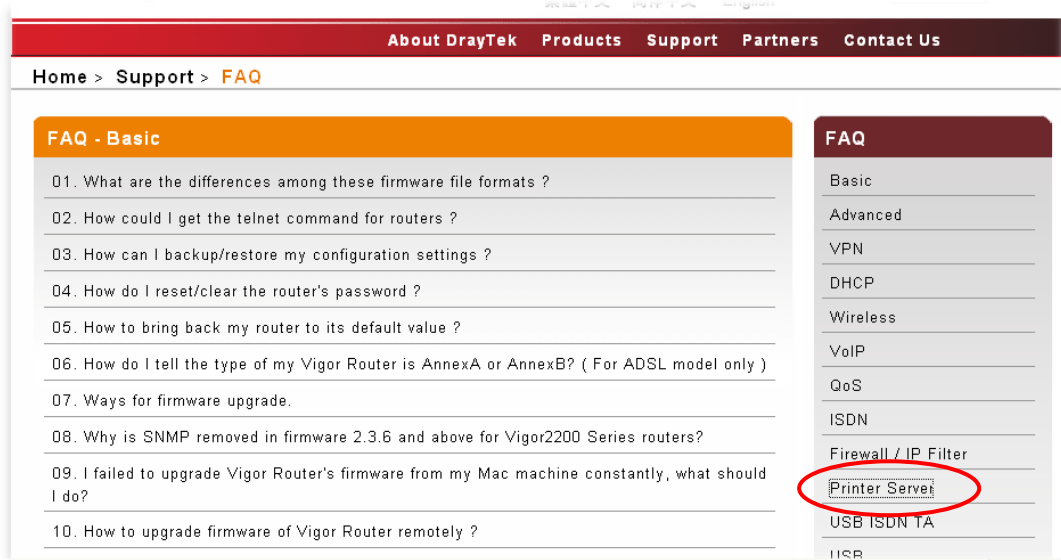

Note 2: Vigor router supports printing request from computers via LAN ports but not DSL port.

This page is left blank.

3. Configuring Web Pages

To access Internet, please finish basic configuration after completing the hardware installation.

3.1 Accessing Web Page

1. Make sure your PC connects to the router correctly.



Notice: You may either simply set up your computer to get IP dynamically from the router or set up the IP address of the computer to be the same subnet as **the default IP address of Vigor router 192.168.1.1**. For the detailed information, please refer to the later section - Trouble Shooting of the guide.

2. Open a web browser on your PC and type **http://192.168.1.1**. The following window will be open to ask for username and password.

The image shows a web browser window with a login form. The form has two input fields: 'Username' and 'Password'. Below the fields is a 'Login' button. At the bottom of the window, there is a red bar with the text 'Copyright©, DrayTek Corp. All Rights Reserved.' and the 'DrayTek' logo.

3. For user mode, do not type any word on the window and click **Login** for the simple configuration. Yet, for admin mode, please type “admin/admin” on Username/Password and click **Login** for full configuration.



Notice: If you fail to access to the web configuration, please go to “Trouble Shooting” for detecting and solving your problem.

4. The web page can be logged out according to the chosen condition. The default setting is **Auto Logout**, which means the web configuration system will logout after five minutes without any operation. Change the setting for your necessity.

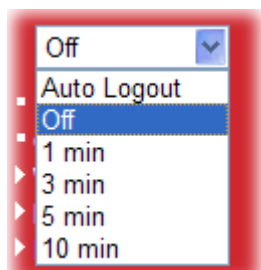

3.2 Basic Configuration

The **Quick Start Wizard** is designed for you to easily set up your router for Internet access. You can directly access the **Quick Start Wizard** via Web Configurator.

1. Open a web browser on your PC and type **http://192.168.1.1**. The system will ask you to type username/password. The displayed web pages will change according to the username and password typed. Here we take simple web pages for example. So, do not type any word on the window and click **Login**.



Notice: For advanced configuration (admin mode), please refer to User's Guide for more detailed information.

2. Now, the **Main Screen** for user operation will appear. Click **Quick Start Wizard**.

Vigor2750 Series
High Speed VDSL2 Router

DrayTek

Auto Logout

- Quick Start Wizard
- Online Status
- VDSL
- WAN
- LAN
- NAT
- Bandwidth Management
- Applications
- USB Application
- IPv6
- User
- System Maintenance

Logout

All Rights Reserved.

User mode

System Status

Auto-refresh

Model : Vigor2750Vn
Firmware Version : v1.4.0_RC2
Build Date/Time : Thu Aug 12 10:21:15 CST 2010
System Date : Thu Jan 1 00:18:56 1970
System Uptime : 1136

System	
CPU Usage	: 14%
Memory Usage	: 25868K / 62796K (41.19%)
Cached Memory	: 9884K / 62796K <input type="button" value="Clean"/>

WAN	
Connection Mode	: DHCP
Link Status	: Disconnected
MAC Address	: 00:1D:07:C9:FA:F9
IP Address	: ---
Default Gateway	: ---
Primary DNS	: ---
Secondary DNS	: ---

LAN	
MAC Address	: 00:1D:07:C9:FA:F8
IP Address	: 192.168.1.1
IP Mask	: 255.255.255.0
IPv6 Address	: 2000::1/64 (Global)
IPv6 Address	: fe80::200:ff:fe00:0/64 (Link)
DHCP Server	: Yes

The home page will change slightly in accordance with the router you have. Here we take Vigor2750 as an example.

3. The welcome page will be shown as below. Please click **Next**.

Quick Start Wizard

Welcome to the Quick Start Wizard!

The next steps will guide you through a basic setup of the device.
If you want more advanced setup you should consider setting the device up manually.

- Step 1: Setup the Password
- Step 2: Setup the Timezone
- Step 3: Setup the Internet connection (WAN)
- Step 4: Save the configuration

< Back

Next >

Finish

Cancel

4. Enter the login password on the field of **New Password** and retype it on the field of **Confirm Password**. Then click **Next** to continue. After restarting the router, new password must be typed for accessing into router web page.

Quick Start Wizard

User Password

New Password

••••

Confirm Password

••••

< Back

Next >

Finish

Cancel

5. On the next page as shown below, please choose time zone for your router. Set/add NTP server(s). Then click **Next** for next step.

Quick Start Wizard

Time Configuration

Time Zone

NTP Servers

Delete	<input type="text" value="pool.ntp.org"/>
Delete	<input type="text" value="time.windows.com"/>
Delete	<input type="text" value="time.nist.gov"/>
Delete	<input type="text" value="time.stdtime.gov.tw"/>

6. On the next page as shown below, please select the appropriate Internet access type **according to the information from your ISP**. For example, you should select PPPoE mode if the ISP provides you PPPoE interface.

Quick Start Wizard

WAN IP Configuration

Connection Type

Clone MAC Address
Enable

Static IP: if you click Static IP, you will get the following page. Please type in the IP address information originally provided by your ISP. Then click **Next** for next step.

Quick Start Wizard

WAN IP Configuration

Connection Type Static IP ▾

Static IP

IP Address	172.16.3.229
Subnet Mask	255.255.0.0
Gateway	172.16.3.4
Primary DNS Server	0.0.0.0
Secondary DNS Server	0.0.0.0

Clone MAC Address

Enable

< Back Next > Finish Cancel

DHCP: if you click DHCP, you will get the following page. Simply click **Next** to continue.

Quick Start Wizard

WAN IP Configuration

Connection Type DHCP ▾

Clone MAC Address

Enable Clone MAC Address

MAC Address 00-0E-A6-2A-D5-A1

< Back Next > Finish Cancel

PPPoE: if you click PPPoE as the protocol, please manually enter the Username/Password provided by your ISP and all the required information. Then, click **Next**.

Quick Start Wizard

WAN IP Configuration

Connection Type	PPPoE
PPPoE	
Username	<input type="text"/>
Password	<input type="text"/>
Confirm Password	<input type="text"/>
Redial Policy	Connect on Demand
Idle Time out	<input type="text"/>
MTU Size	<input type="text"/>
Clone MAC Address	
Enable	<input type="checkbox"/>

< Back Next > Finish Cancel

PPTP/L2TP: if you click PPTP/L2TP as the protocol, please manually enter the Username/Password provided by your ISP and all the required information. Then, click **Next**.

Quick Start Wizard

WAN IP Configuration

Connection Type	PPTP
PPTP Settings	
Username	<input type="text"/>
Password	<input type="text"/>
Server Address	<input type="text"/>
WAN IP Network Settings	Static IP
IP Address	0.0.0.0
Subnet Mask	0.0.0.0
Redial Policy	Connect on Demand
Idle Time out	<input type="text"/>
MTU Size	<input type="text"/>
Clone MAC Address	
Enable	<input type="checkbox"/>

< Back Next > Finish Cancel

7. Now you can see the following screen. It indicates that the setup is complete. Different types of connection modes will have different summary. Click **Finish** and then restart the router.

Quick Start Wizard

Vigor Wizard Setup is now finished!

Press **Finish** button to save and finish the wizard setup.
You will be prompted for the new password.
Note that the configuration process takes a few seconds to complete.

< Back

Next >

Finish

Cancel

Now, you can enjoy surfing on the Internet.

This page is left blank.

4. Trouble Shooting

This section will guide you to solve abnormal situations if you cannot access into the Internet after installing the router and finishing the web configuration. Please follow sections below to check your basic installation status stage by stage.

- Checking if the hardware status is OK or not.
- Checking if the network connection settings on your computer are OK or not.
- Pinging the router from your computer.
- Checking if the ISP settings are OK or not.
- Backing to factory default setting if necessary.

If all above stages are done and the router still cannot run normally, it is the time for you to contact your dealer for advanced help.

4.1 Checking If the Hardware Status Is OK or Not

Follow the steps below to verify the hardware status.

1. Check the power line and LAN cable connections. Refer to “**2.1 Hardware Installation**” for details.
2. Turn on the router. Make sure the **ACT LED** blink once per second and the correspondent **LAN LED** is bright.

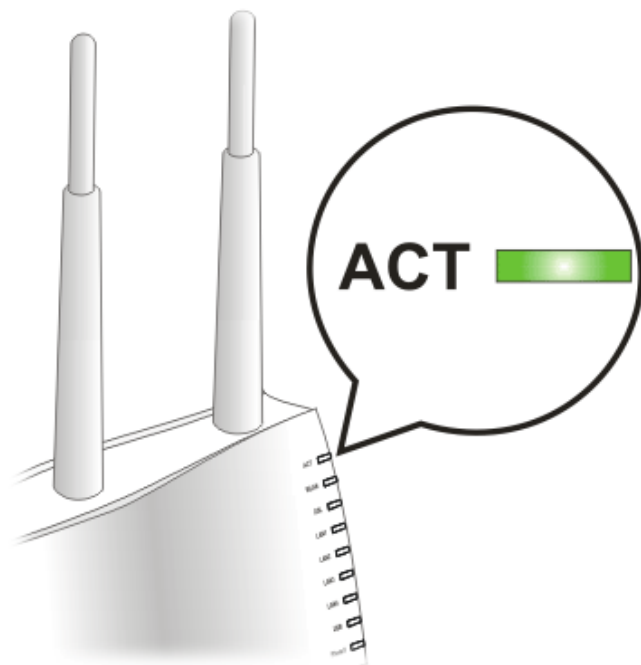

3. If not, it means that there is something wrong with the hardware status. Simply back to “**2.1 Hardware Installation**” to execute the hardware installation again. And then, try again.

4.2 Checking If the Network Connection Settings on Your Computer Is OK or Not

Sometimes the link failure occurs due to the wrong network connection settings. After trying the above section, if the link is still failed, please do the steps listed below to make sure the network connection settings is OK.

For Windows



The example is based on Windows XP. As to the examples for other operation systems, please refer to the similar steps or find support notes in www.draytek.com.

1. Go to **Control Panel** and then double-click on **Network Connections**.



2. Right-click on **Local Area Connection** and click on **Properties**.

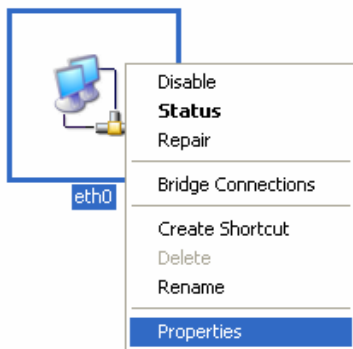

3. Select **Internet Protocol (TCP/IP)** and then click **Properties**.

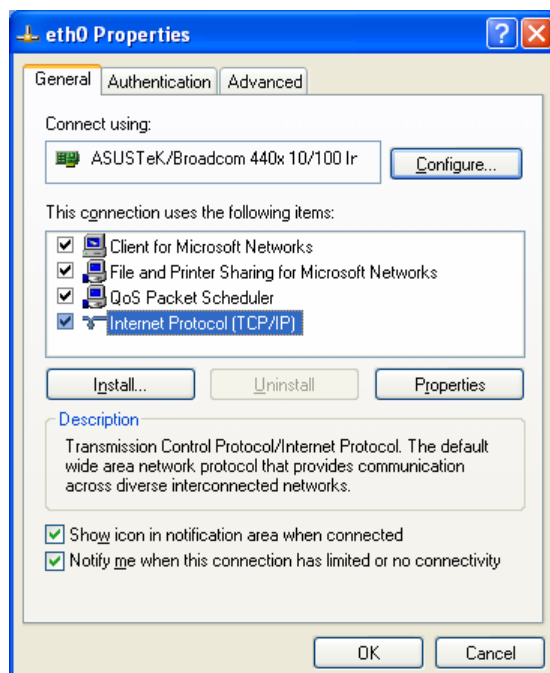

4. Select **Obtain an IP address automatically** and **Obtain DNS server address automatically**.

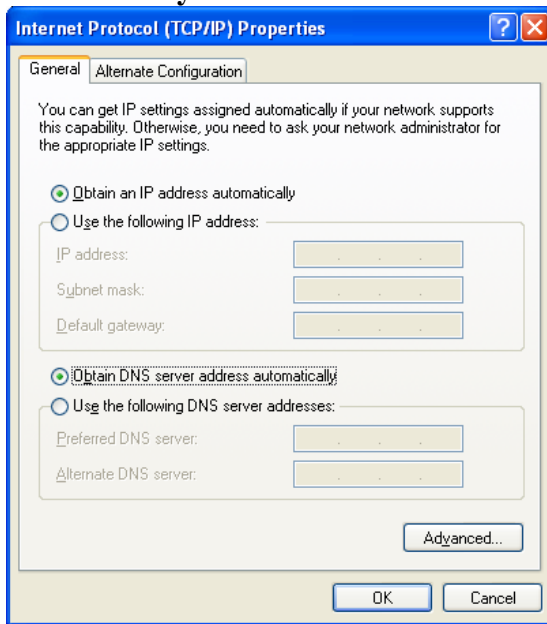

For MacOs

1. Double click on the current used MacOs on the desktop.
2. Open the **Application** folder and get into **Network**.
3. On the **Network** screen, select **Using DHCP** from the drop down list of Configure IPv4.

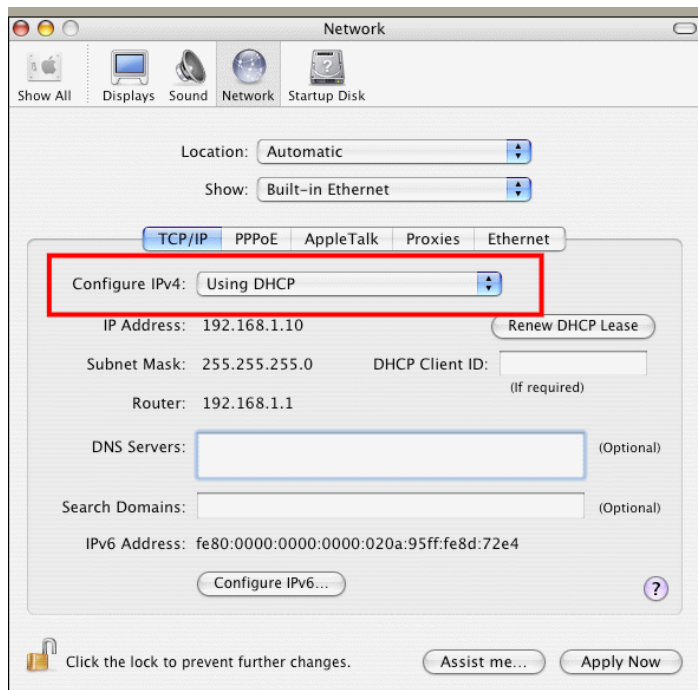

4.3 Pinging the Router from Your Computer

The default gateway IP address of the router is 192.168.1.1. For some reason, you might need to use “ping” command to check the link status of the router. **The most important thing is that the computer will receive a reply from 192.168.1.1.** If not, please check the IP address of your computer. We suggest you setting the network connection as **get IP automatically**. (Please refer to the section 4.2)

Please follow the steps below to ping the router correctly.

For Windows

1. Open the **Command Prompt** window (from **Start menu> Run**).
2. Type **command** (for Windows 95/98/ME) or **cmd** (for Windows NT/2000/XP/Vista). The DOS command dialog will appear.

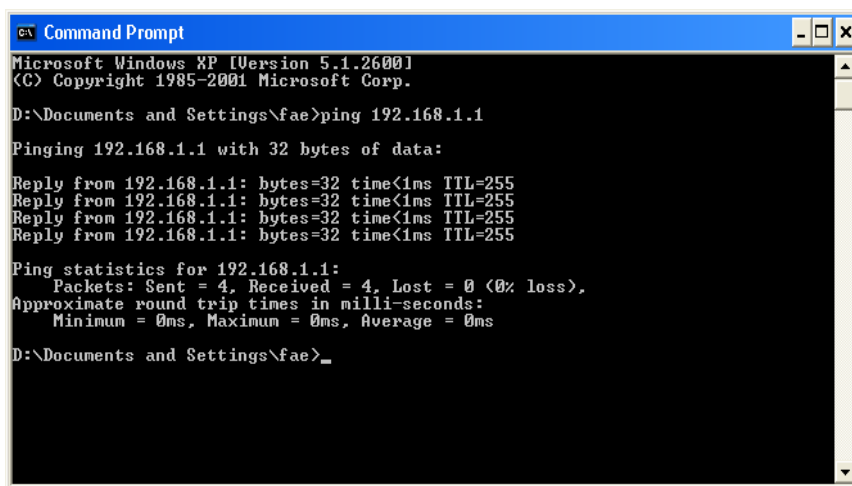

```
Microsoft Windows XP [Version 5.1.2600]
(C) Copyright 1985-2001 Microsoft Corp.

D:\Documents and Settings\fae>ping 192.168.1.1

Pinging 192.168.1.1 with 32 bytes of data:

Reply from 192.168.1.1: bytes=32 time<1ms TTL=255
Reply from 192.168.1.1: bytes=32 time<1ms TTL=255
Reply from 192.168.1.1: bytes=32 time<1ms TTL=255
Reply from 192.168.1.1: bytes=32 time<1ms TTL=255

Ping statistics for 192.168.1.1:
    Packets: Sent = 4, Received = 4, Lost = 0 (0% loss),
    Approximate round trip times in milli-seconds:
        Minimum = 0ms, Maximum = 0ms, Average = 0ms

D:\Documents and Settings\fae>_
```

3. Type **ping 192.168.1.1** and press [Enter]. If the link is OK, the line of “**Reply from 192.168.1.1: bytes=32 time<1ms TTL=255**” will appear.
4. If the line does not appear, please check the IP address setting of your computer.

For MacOs (Terminal)

1. Double click on the current used MacOs on the desktop.
2. Open the **Application** folder and get into **Utilities**.
3. Double click **Terminal**. The Terminal window will appear.
4. Type **ping 192.168.1.1** and press [Enter]. If the link is OK, the line of “**64 bytes from 192.168.1.1: icmp_seq=0 ttl=255 time=xxxx ms**” will appear.

```

Terminal — bash — 80x24
Last login: Sat Jan  3 02:24:18 on ttty1
Welcome to Darwin!
Vigor10:~ draytek$ ping 192.168.1.1
PING 192.168.1.1 (192.168.1.1): 56 data bytes
64 bytes from 192.168.1.1: icmp_seq=0 ttl=255 time=0.755 ms
64 bytes from 192.168.1.1: icmp_seq=1 ttl=255 time=0.697 ms
64 bytes from 192.168.1.1: icmp_seq=2 ttl=255 time=0.716 ms
64 bytes from 192.168.1.1: icmp_seq=3 ttl=255 time=0.731 ms
64 bytes from 192.168.1.1: icmp_seq=4 ttl=255 time=0.72 ms
^C
--- 192.168.1.1 ping statistics ---
5 packets transmitted, 5 packets received, 0% packet loss
round-trip min/avg/max = 0.697/0.723/0.755 ms
Vigor10:~ draytek$ █

```

4.4 Checking If the ISP Settings are OK or Not

Open **WAN>>Internet Access** page and then check whether the ISP settings are set correctly. Use the Connection Type drop down list to choose Static IP/DHCP/PPPoE/PPTP/L2TP/3G USB Modem for reviewing the settings that you configured previously.



WAN >> Internet Access

WAN IP Configuration

Enable	<input checked="" type="checkbox"/>	
Connection Type	<div style="border: 1px solid black; padding: 2px;"> DHCP <ul style="list-style-type: none"> Static IP <li style="background-color: #e0e0e0;">DHCP PPPoE PPTP L2TP 3G USB Modem </div>	
DHCP Settings		
Router Name		(The same as syslog's router name)
Domain Name		(Domain Name are required for some ISPs)

WAN Connection Detection

Mode	<div style="border: 1px solid black; padding: 2px;"> ARP <ul style="list-style-type: none"> ARP </div>
Ping IP	<input type="text" value="0.0.0.0"/>

Clone MAC Address

Enable	<input type="checkbox"/>
--------	--------------------------

Take Static Users for example

1. Choose **Static IP** as the connection type.

WAN >> Internet Access

WAN IP Configuration

Connection Type	Static IP
-----------------	-----------

Static IP Settings

IP Address	172.16.3.102
Subnet Mask	255.255.0.0
Gateway IP Address	172.16.1.1
Primary DNS Server	168.95.1.1
Secondary DNS Server	0.0.0.0

WAN Connection Detection

Mode	ARP
Ping IP	0.0.0.0

Clone MAC Address

Enable	<input type="checkbox"/>
--------	--------------------------

OK

2. Check if **IP Address**, **IP Mask** and **IP Router** are set correctly (must identify with the values from your ISP).

4.5 Backing to Factory Default Setting If Necessary

Sometimes, a wrong connection can be improved by returning to the default settings. Try to reset the router by software or hardware.



Warning: After pressing **factory default setting**, you will lose all settings you did before. Make sure you have recorded all useful settings before you pressing.

Software Reset

You can reset the router to factory default via Web page.

Go to **System Maintenance** and choose **Reboot System** on the web page. The following screen will appear. Choose **Using factory default configuration** and click **OK**. After few seconds, the router will return all the settings to the factory settings.

Reboot System

Do You want to reboot your router ?

Using current configuration
 Using factory default configuration

Hardware Reset

While the router is running (ACT LED blinking), press the **Factory Reset** button and hold for more than 5 seconds. When you see the **ACT** LED blinks rapidly, please release the button. Then, the router will restart with the default configuration.

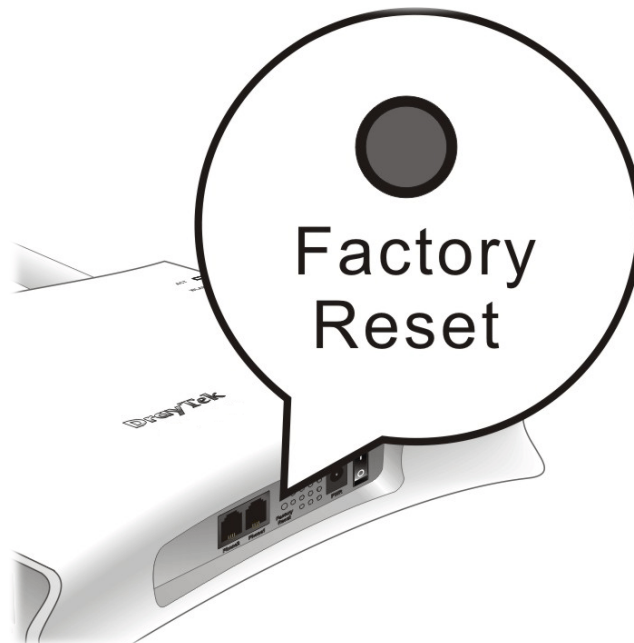

After restore the factory default setting, you can configure the settings for the router again to fit your personal request.

4.6 Contacting Your Dealer

If the router still cannot work correctly after trying many efforts, please contact your dealer for further help right away. For any questions, please feel free to send e-mail to support@draytek.com.