

# DrayTek

## VigorSwitch P2261

PoE 24+2 Giga Port L2 Managed Switch



*Your reliable networking solutions partner*

# User's Guide

**V1.0**

# **VigorSwitch P2261 PoE 24+2 Giga Port L2 Managed Switch User's Guide**

**Version: 1.0**

**Date: 24/09/2012**

Copyright 2012 All rights reserved.

## Copyright Information

### Copyright Declarations

Copyright 2012 All rights reserved. This publication contains information that is protected by copyright. No part may be reproduced, transmitted, transcribed, stored in a retrieval system, or translated into any language without written permission from the copyright holders.

### Trademarks

The following trademarks are used in this document:

- Microsoft is a registered trademark of Microsoft Corp.
- Windows, Windows 95, 98, Me, NT, 2000, XP and Explorer are trademarks of Microsoft Corp.
- Apple and Mac OS are registered trademarks of Apple Inc.
- Other products may be trademarks or registered trademarks of their respective manufacturers.

## Caution and Electronic Emission Notices

### Caution

Circuit devices are sensitive to static electricity, which can damage their delicate electronics. Dry weather conditions or walking across a carpeted floor may cause you to acquire a static electrical charge.

To protect your device, always:

- Touch the metal chassis of your computer to ground the static electrical charge before you pick up the circuit device.
- Pick up the device by holding it on the left and right edges only.

### Warranty

We warrant to the original end user (purchaser) that the device will be free from any defects in workmanship or materials for a period of **one (1)** years from the date of purchase from the dealer. Please keep your purchase receipt in a safe place as it serves as proof of date of purchase. During the warranty period, and upon proof of purchase, should the product have indications of failure due to faulty workmanship and/or materials, we will, at our discretion, repair or replace the defective products or components, without charge for either parts or labor, to whatever extent we deem necessary to restore the product to proper operating condition. Any replacement will consist of a new or re-manufactured functionally equivalent product of equal value, and will be offered solely at our discretion. This warranty will not apply if the product is modified, misused, tampered with, damaged by an act of God, or subjected to abnormal working conditions. The warranty does not cover the bundled or licensed software of other vendors. Defects which do not significantly affect the usability of the product will not be covered by the warranty. We reserve the right to revise the manual and online documentation and to make changes from time to time in the contents hereof without obligation to notify any person of such revision or changes.

### Be a Registered Owner

Web registration is preferred. You can register your Vigor device via <http://www.draytek.com>.

### Firmware & Tools Updates

Due to the continuous evolution of DrayTek technology, all devices will be regularly upgraded. Please consult the DrayTek web site for more information on newest firmware, tools and documents.

<http://www.draytek.com>

## European Community Declarations

Manufacturer: DrayTek Corp.

Address: No. 26, Fu Shing Road, HuKou Township, HsinChu Industrial Park, Hsin-Chu County, Taiwan  
303

Product: VigorSwitch Series Device

The product conforms to the requirements of Electro-Magnetic Compatibility (EMC) Directive 2004/108/EC by complying with the requirements set forth in EN55022/Class A and EN55024/Class **A**.

The product conforms to the requirements of Low Voltage (LVD) Directive 2006/95/EC by complying with the requirements set forth in EN6095-1.

## Regulatory Information

### Federal Communication Commission Interference Statement

This equipment has been tested and found to comply with the limits for a Class A digital device, pursuant to Part 15 of the FCC Rules. These limits are designed to provide reasonable protection against harmful interference in a residential installation. This equipment generates, uses and can radiate radio frequency energy and, if not installed and used in accordance with the instructions, may cause harmful interference to radio communications. However, there is no guarantee that interference will not occur in a particular installation. If this equipment does cause harmful interference to radio or television reception, which can be determined by turning the equipment off and on, the use is encouraged to try to correct the interference by one of the following measures:

- Reorient or relocate the receiving antenna.
- Increase the separation between the equipment and receiver.
- Connect the equipment into an outlet on a circuit different from that to which the receiver is connected.
- Consult the dealer or an experienced radio/TV technician for help.

This device complies with Part 15 of the FCC Rules. Operation is subject to the following two conditions:

- (1) This device may not cause harmful interference, and
- (2) This device may accept any interference received, including interference that may cause undesired operation.



## Table of Contents

<b>Chapter 1: Introduction .....</b>	<b>1</b>
1.1 Overview .....	1
1.2 Features .....	3
1.3 Packing List.....	4
1.4 LED Indicators and Connectors .....	5
1.5 Hardware Installation .....	6
1.5.1 Connecting the SFP Fiber Transceiver to the Chassis .....	6
1.5.2 Installing Optional SFP Fiber Transceivers to the switch .....	7
1.5.3 Installing Chassis to a 19-Inch Wiring Closet Rail.....	7
1.5.4 Cabling Requirements .....	8
1.5.5 Configuring the Management Agent of Switch .....	12
1.5.6 IP Address Assignment .....	13
1.6 Typical Applications.....	17
<b>Chapter 2: Operation of Web-based Management .....</b>	<b>19</b>
2.1 Web Management Home Overview .....	20
2.1.1 The Information of Page Layout .....	21
2.2 System .....	22
2.2.1 System Information - Information .....	22
2.2.2 System Information – Device Name .....	23
2.2.3 System Information – CPU Load .....	24
2.2.4 NTP & Time Configuration.....	25
2.2.5 Account - Users .....	26
2.2.6 Account – Privilege Level .....	28
2.2.7 IP Configuration – IPv4.....	29
2.2.8 IP Configuration – IPv6.....	30
2.2.9 Port – General Setup .....	32
2.2.10 Port – Traffic Overview .....	34
2.2.11 Port - Detailed Statistics .....	35
2.2.12 Port - QoS Statistics .....	36
2.2.13 Port - SFP Information.....	38
2.2.14 Port - EEE .....	39
2.2.15 Loop Protection – General Setup .....	40
2.2.16 Loop Protection – Status .....	41
2.2.17 Trap Event Severity .....	42
2.2.18 SNMP - System .....	43
2.2.19 SNMP – General Setup .....	44
2.2.20 SNMP – Communities .....	45
2.2.21 SNMP – Users .....	46
2.2.22 SNMP – Groups.....	48
2.2.23 SNMP – Views.....	49
2.2.24 SNMP – Access.....	50
2.2.25 SNMP – Trap.....	52
2.2.26 System Log – General Setup .....	54
2.2.27 System Log – Log.....	55
2.2.28 System Log – Detailed Log .....	56
2.2.29 SMTP General Setup.....	57
2.2.30 sFlow Agent - Collector.....	58
2.2.31 sFlow Agent - Sampler .....	59
2.3 Configuration.....	61

2.3.1 Aggregation – Static Trunk .....	61
2.3.2 Aggregation – LACP – General Setup .....	63
2.3.3 Aggregation – LACP – System Status .....	64
2.3.4 Aggregation –LACP – Port Status & Statistics .....	65
2.3.5 Spanning Tree – Bridge Settings .....	66
2.3.6 Spanning Tree – MSTI Mapping .....	68
2.3.7 Spanning Tree – MSTI Priorities .....	69
2.3.8 Spanning Tree – CIST Ports .....	70
2.3.9 Spanning Tree – MSTI Ports .....	72
2.3.10 Spanning Tree – Bridge Status .....	73
2.3.11 Spanning Tree – Port Status .....	74
2.3.12 Spanning Tree – Port Statistics .....	75
2.3.13 IGMP Snooping – General Setup .....	76
2.3.14 IGMP Snooping – VLAN General Setup .....	78
2.3.15 IGMP Snooping – Port Group Filtering .....	79
2.3.16 IGMP Snooping – Status .....	81
2.3.17 IGMP Snooping – Groups Information .....	82
2.3.18 IGMP Snooping- IPv4 SSM Information .....	83
2.3.19 MLD Snooping – General Setup .....	84
2.3.20 MLD Snooping – VLAN General Setup .....	86
2.3.21 MLD Snooping – Port Group Filtering .....	88
2.3.22 MLD Snooping – Status .....	89
2.3.23 MLD Snooping – Groups Information .....	90
2.3.24 MLD Snooping- IPv6 SSM Information .....	91
2.3.25 MVR – General Setup .....	92
2.3.26 MVR - Group Information .....	93
2.3.27 MVR – Statistics .....	94
2.3.28 LLDP – LLDP General Setup .....	95
2.3.29 LLDP – LLDP Neighbours .....	97
2.3.30 LLDP – LLDP-MED General Setup .....	98
2.3.31 LLDP – LLDP-MED Neighbours .....	105
2.3.32 LLDP – EEE .....	109
2.3.33 LLDP – Port Statistics .....	111
2.3.34 PoE – General Setup .....	112
2.3.35 PoE – Status .....	113
2.3.36 PoE – Power Delay .....	114
2.3.37 PoE – Auto Checking .....	115
2.3.38 PoE – Schedule .....	116
2.3.39 Filtering Data Base – General Setup .....	116
2.3.40 Filtering Data Base – Dynamic MAC Table .....	118
2.3.41 VLAN – VLAN Membership .....	119
2.3.42 VLAN – Ports .....	120
2.3.43 VLAN – Switch Status .....	123
2.3.44 VLAN – Port Status .....	124
2.3.45 VLAN – Private VLANs – Private VLAN Membership .....	126
2.3.46 VLAN – Private VLANs – Port Isolation .....	128
2.3.47 VLAN – MAC-based VLAN – General Setup .....	129
2.3.48 VLAN – MAC-based VLAN – Status .....	131
2.3.49 VLAN – Protocol-based VLAN – Protocol Group .....	132
2.3.50 VLAN – Protocol-based VLAN – Group to VLAN .....	134
2.3.51 Voice VLAN – General Setup .....	135
2.3.52 Voice VLAN – QUI .....	137
2.3.53 GARP – General Setup .....	137
2.3.54 GARP – Statistics .....	139
2.3.55 GVRP – General Setup .....	140
2.3.56 QoS – Port Classification .....	141
2.3.57 QoS – Port Policing .....	143
2.3.58 QoS – Port Scheduler .....	144
2.3.59 QoS – Port Shaping .....	145
2.3.60 QoS – Tag Remarking .....	146

2.3.61 QoS – DSCP.....	147
2.3.62 QoS – DSCP-Based QoS.....	148
2.3.63 QoS – DSCP Translation.....	149
2.3.64 QoS – DSCP Classification .....	150
2.3.65 QoS – QoS Control List .....	151
2.3.66 QoS – QoS Status .....	155
2.3.67 QoS – Storm Control .....	156
2.3.68 Single IP – General Setup .....	157
2.3.69 Single IP – Information .....	158
2.3.70 Easy Port .....	159
2.3.71 Mirroring.....	161
2.3.72 UPnP.....	162
2.4 Security .....	163
2.4.1 ACL - Ports .....	163
2.4.2 ACL – Rate Limiters.....	165
2.4.3 ACL – Access Control List.....	166
2.4.4 ACL – ACL Status.....	170
2.4.5 IP Source Guard – General Setup.....	172
2.4.6 IP Source Guard – Static Table.....	173
2.4.7 IP Source Guard – Dynamic Table.....	174
2.4.8 ARP Inspection – General Setup.....	175
2.4.9 ARP Inspection – Static Table.....	176
2.4.10 ARP Inspection – Dynamic Table.....	177
2.4.11 DHCP Snooping – General Setup.....	178
2.4.12 DHCP Snooping – Statistics.....	179
2.4.13 DHCP Relay – General Setup .....	180
2.4.14 DHCP Relay – Statistics.....	182
2.4.15 NAS – General Setup .....	183
2.4.16 NAS – Switch Status.....	192
2.4.17 NAS – Port Status.....	194
2.4.18 AAA – General Setup .....	195
2.4.19 AAA – RADIUS Overview.....	198
2.4.20 AAA – RADIUS Details.....	199
2.4.21 Port Security – Limit Control.....	201
2.4.22 Port Security – Switch Status .....	203
2.4.23 Port Security – Port Status .....	205
2.4.24 Access Management – General Setup.....	207
2.4.25 Access Management – Statistics.....	208
2.4.26 SSH.....	209
2.4.27 HTTPS.....	210
2.4.28 Auth Method .....	211
2.5 Maintenance.....	212
2.5.1 Restart Device .....	212
2.5.2 Firmware – Firmware Upgrade.....	213
2.5.3 Firmware – Firmware Selection.....	214
2.5.4 Save/Restore – Factory Defaults.....	215
2.5.5 Save/Restore – Save Start .....	216
2.5.6 Save/Restore – Save User .....	217
2.5.7 Save/Restore – Restore User.....	218
2.5.8 Export/Import – Export Config .....	219
2.5.9 Export/Import – Import Config .....	220
2.5.10 Diagnostics – Ping .....	221
2.5.11 Diagnostics – Ping6.....	222
2.5.12 Diagnostics – VeriPHY .....	223
<b>Chapter 3: Trouble Shooting.....</b>	<b>225</b>
3.1 Resolving No Link Condition.....	225

3.2 Q & A ..... 225



# Chapter 1: Introduction

In this user's manual, it will not only tell you how to install and connect your network system but configure and monitor the 24+2 Gigabit L2 plus Switch through the built-in CLI and web by RS-232 serial interface and Ethernet ports step-by-step. Many explanations in detail of hardware and software functions are shown as well as the examples of the operation for web-based interface and command-line interface (CLI).

## 1.1 Overview

The 24+2-port Gigabit L2 Managed Switch, is a standard switch that meets all IEEE 802.3/u/x/z Gigabit, Fast Ethernet specifications. The switch included 24-Port 10/100/1000Mbps TP (20-Port for TP; 4-Port for Combo) and 2-Port Dual-SFP Fiber management Ethernet switch.

The switch can be managed through RS-232 serial port via directly connection, or through Ethernet port using CLI or Web-based management unit, associated with SNMP agent. With the SNMP agent, the network administrator can logon the switch to monitor, configure and control each port's activity in a friendly way. The overall network management is enhanced and the network efficiency is also improved to accommodate high bandwidth applications. In addition, the switch features comprehensive and useful function such as ACL, IP-MAC Binding, DHCP Option 82, QoS (Quality of Service), Spanning Tree, VLAN, Port Trunking, Bandwidth Control, Port Security, SNMP/RMON, IGMP Snooping capability via the intelligent software. It is suitable for both metro-LAN and office application.

In this switch, Port 21 and Port 24 include two types of media --- TP and SFP Fiber (LC, BiDi LC...); this port supports 10/100/1000Mbps TP or 1000Mbps SFP Fiber with auto-detected function. 1000Mbps SFP Fiber transceiver is used for high-speed connection expansion.

- 1000Mbps LC, Multi-Mode, SFP Fiber transceiver
- 1000Mbps LC, 10km, SFP Fiber transceiver
- 1000Mbps LC, 30km, SFP Fiber transceiver
- 1000Mbps LC, 50km, SFP Fiber transceiver
- 1000Mbps BiDi LC, 20km, 1550nm SFP Fiber WDM transceiver
- 1000Mbps BiDi LC, 20km, 1310nm SFP Fiber WDM transceiver

10/100/1000Mbps TP is a standard Ethernet port that meets all IEEE 802.3/u/x/z Gigabit, Fast Ethernet specifications. 1000Mbps SFP Fiber transceiver is a Gigabit Ethernet port that fully complies with all IEEE 802.3z and 1000Base-SX/LX standards.

1000Mbps Single Fiber WDM (BiDi) transceiver is designed with an optic Wavelength Division Multiplexing (WDM) technology that transports bi-directional full duplex signal over a single fiber simultaneously.

For upgrading firmware, please refer to the **Section 2.5.2** for more details. The switch will not stop operating while upgrading firmware and after that, the configuration keeps unchanged.

Below shows key features of this device:

## **QoS**

Support Quality of Service by the IEEE 802.1P standard. There are two priority queue and packet transmission schedule.

## **Spanning Tree**

Support IEEE 802.1D, IEEE 802.1w (RSTP: Rapid Spanning Tree Protocol) standards.

## **VLAN**

Support Port-based VLAN and IEEE802.1Q Tag VLAN. Support 256 active VLANs and VLAN ID 1~4094.

## **Port Trunking**

Support static port trunking and port trunking with IEEE 802.3ad LACP.

## **Bandwidth Control**

Support ingress and egress per port bandwidth control.

## **Port Security**

Support allowed, denied forwarding and port security with MAC address.

## **SNMP/RMON**

SNMP agent and RMON MIB. In the device, SNMP agent is a client software which is operating over SNMP protocol used to receive the command from SNMP manager (server site) and echo the corresponded data, i.e. MIB object. Besides, SNMP agent will actively issue TRAP information when happened.

RMON is the abbreviation of Remote Network Monitoring and is a branch of the SNMP MIB.

The device supports MIB-2 (RFC 1213), Bridge MIB (RFC 1493), RMON MIB (RFC 1757)-statistics Group 1,2,3,9, Ethernet-like MIB (RFC 1643), Ethernet MIB (RFC 1643) and so on.

## **IGMP Snooping**

Support IGMP version 2 (RFC 2236): The function IGMP snooping is used to establish the multicast groups to forward the multicast packet to the member ports, and, in nature, avoid wasting the bandwidth while IP multicast packets are running over the network.

## **IGMP Proxy**

The implementation of IP multicast processing. The switch supports IGMP version 1 and IGMP version 2, efficient use of network bandwidth, and fast response time for channel changing. IGMP version 1 (IGMPv1) is described in RFC1112, and IGMP version 2 (IGMPv2) is described in RFC 2236. Hosts interact with the system through the exchange of IGMP messages. Similarly, when you configure IGMP proxy, the system interacts with the router on its upstream interface through the exchange of IGMP messages. However, when acting as the proxy, the system performs the host portion of the IGMP task on the upstream interface as follows:

- When queried, sends group membership reports to the group.

- When one of its hosts joins a multicast address group to which none of its other hosts belong, sends unsolicited group membership reports to that group.
- When the last of its hosts in a particular multicast group leaves the group, sends an unsolicited leave group membership report to the all-routers group (244.0.0.2).

## 1.2 Features

The VigorSwitch P2261, a standalone off-the-shelf switch, provides the comprehensive features listed below for users to perform system network administration and efficiently and securely serve your network.

### Hardware

- 20 10/100/1000Mbps Auto-negotiation Gigabit Ethernet TP ports
- 4 10/100/1000Mbps Combo ports
- 2 100/1000Mbps Dual-SFP Fiber media auto sense
- 1392KB on-chip frame buffer
- Support jumbo frame up to 9600 bytes
- Programmable classifier for QoS (Layer 4/Multimedia)
- 8K MAC address and 4K VLAN support (IEEE802.1Q)
- Per-port shaping, policing, and Broadcast Storm Control
- IEEE802.1Q Q-in-Q nested VLAN support
- Full-duplex flow control (IEEE802.3x) and half-duplex backpressure
- Extensive front-panel diagnostic LEDs; System: Power, TP Port1-24: LINK/ACT, 10/100/1000Mbps, SFP Port 21-24: SFP(LINK/ACT)

### Management

- Supports concisely the status of port and easily port configuration
- Supports per port traffic monitoring counters
- Supports a snapshot of the system Information when you login
- Supports port mirror function
- Supports the static trunk function
- Supports 802.1Q VLAN
- Supports user management and limits three users to login
- Maximal packet length can be up to 9600 bytes for jumbo frame application
- Supports DHCP Broadcasting Suppression to avoid network suspended or crashed
- Supports to send the trap event while monitored events happened
- Supports default configuration which can be restored to overwrite the current configuration which is working on via web browser and CLI
- Supports on-line plug/unplug SFP modules
- Supports Quality of Service (QoS) for real time applications based on the information taken from Layer 2 to Layer 4, such as VoIP

- Built-in web-based management and CLI management, providing a more convenient UI for the user
- Supports port mirror function with ingress/egress traffic
- Supports rapid spanning tree (802.1w RSTP)
- Supports multiple spanning tree (802.1s MSTP)
- Supports 802.1X port security on a VLAN
- Supports IP-MAC-Port Binding for LAN security
- Supports user management and only first login administrator can configure the device. The rest of users can only view the switch
- SNMP access can be disabled and prevent from illegal SNMP access
- Supports Ingress, Non-unicast and Egress Bandwidth rating management with a resolution of 1Mbps
- The trap event and alarm message can be transferred via e-mail
- Supports diagnostics to let administrator knowing the hardware status
- Supports loop detection to protect the switch crash when the networking has looping issue
- HTTP and TFTP for firmware upgrade, system log upload and configuration file import/export
- Supports remote boot the device through user interface and SNMP
- Supports NTP network time synchronization and daylight saving
- Supports 120 event log records in the main memory and display on the local console

### 1.3 Packing List

Before you start installing the switch, verify that the package contains the following:

- VigorSwitch P2261
- AC Power Cord
- CD
- Console Cable
- Rubber feet
- Rack mount kit

Please notify your sales representative immediately if any of the aforementioned items is missing or damaged.

#### **Optional Modules**

In the switch, Port 21~24 includes two types of media --- TP and SFP Fiber (LC, BiDi LC...); this port supports 10/100/1000Mbps TP or 1000Mbps SFP Fiber with auto-detected function. 1000Mbps SFP Fiber transceiver is used for high-speed connection expansion; the following are optional SFP types compatible for the switch:

- 1000Mbps LC, MM, SFP Fiber transceiver
- 1000Mbps LC, SM 10km, SFP Fiber transceiver
- 1000Mbps LC, SM 30km, SFP Fiber transceiver

- 1000Mbps LC, SM 50km, SFP Fiber transceiver
- 1000Mbps BiDi LC, type 1, SM 20km, SFP Fiber WDM transceiver
- 1000Mbps BiDi LC, type 2, SM 20km, SFP Fiber WDM transceiver
- 1000Mbps LC, SM 10km, SFP Fiber transceiver with DDM



Front View of 1000Base-SX/LX LC, SFP Fiber Transceiver



Front View of 1000Base-LX BiDi LC, SFP Fiber Transceiver

## 1.4 LED Indicators and Connectors

Before you use the Vigor device, please get acquainted with the LED indicators and connectors first.

There are 24 TP Fast Ethernet ports and 2 slots for optional removable modules on the front panel of the switch. LED display area, locating on the front panel, contains a ACT, Power LED and 26 ports working status of the switch.

### LED Explanation



LED	Color	Explanation
POWER	Green	Lit when +3.3V power is coming up.
TP Port 1– 24 (RJ45 LEFT) LINK/ACT	Green	Lit when connection with remote device is good. Blinks when any traffic is present.
TP Port 1– 24 (RJ45 RIGHT) SPEED	Green	Lit Green when TP connection with remote device is 1000M. Blinks when TP connection with remote device is 100M. Off when TP connection with remote device is 10M.
SFP Port 21-24 LINK/ACT	Green/ Amber	Lit Green when TP connection with remote device is 1000M.. Lit Amber when TP connection with remote device is 100M. Blinks when any traffic is present.
SFP Port 25-26 LINK/ACT	Green/ Amber	Lit Green when the connection with remote device is 1000M. Lit Amber when the connection with remote device is 100M. Blinks when any traffic is present.

## Connector Explanation

Interface	Description
RESET	Used to restart the device to default settings.
CONSOLE	Used to perform telnet command control.
LAN P1 – P24	Giga Ethernet Port.
SFP (21 – 26)	SFP Fiber Port.

## User Interfaces on the Rear Panel



One socket on the rear panel is for AC power input.

## 1.5 Hardware Installation

At the beginning, please do first:

- Wear a grounding device to avoid the damage from electrostatic discharge
- Be sure you have inserted the power cord to power source

### 1.5.1 Connecting the SFP Fiber Transceiver to the Chassis

The optional SFP modules are hot swappable, so you can plug or unplug it before or after powering on.

1. Verify that the SFP module is the right model and conforms to the chassis
2. Slide the module along the slot. Also be sure that the module is properly seated against the slot socket/connector
3. Install the media cable for network connection
4. Repeat the above steps, as needed, for each module to be installed into slot(s)
5. Have the power ON after the above procedures are done

### TP Port and Cable Installation

In the switch, TP port supports MDI/MDI-X auto-crossover, so both types of cable, straight-through (Cable pin-outs for RJ-45 jack 1, 2, 3, 6 to 1, 2, 3, 6 in 10/100M TP; 1, 2, 3, 4, 5, 6, 7, 8 to 1, 2, 3, 4, 5, 6, 7, 8 in Gigabit TP) and crossed-over (Cable pin-outs for RJ-45 jack 1, 2, 3, 6 to 3, 6, 1, 2) can be used. It means you do not have to tell from them, just plug it.

1. Use Cat. 5 grade RJ-45 TP cable to connect to a TP port of the switch and the other end is connected to a network-aware device such as a workstation or a server.
2. Repeat the above steps, as needed, for each RJ-45 port to be connected to a Gigabit 10/100/1000 TP device.
3. Now, you can start having the switch in operation.

## Power On

The switch supports 100-240 VAC, 50-60 Hz power supply. The power supply will automatically convert the local AC power source to DC power. It does not matter whether any connection plugged into the switch or not when power on, even modules as well. After the power is on, all LED indicators will light up immediately and then all off except the power LED still keeps on. This represents a reset of the system.

## Firmware Loading

After resetting, the bootloader will load the firmware into the memory. It will take about 30 seconds, after that, the switch will flash all the LED once and automatically performs self-test and is in ready state.

### 1.5.2 Installing Optional SFP Fiber Transceivers to the switch

If you have no modules, please skip this section.

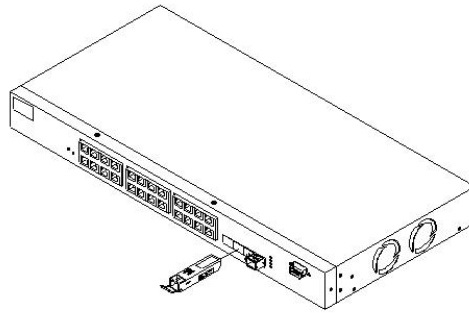

### 1.5.3 Installing Chassis to a 19-Inch Wiring Closet Rail

**Caution:** Allow a proper spacing and proper air ventilation for the cooling fan at both sides of the chassis.

1. Wear a grounding device for electrostatic discharge.
2. Screw the mounting accessory to the front side of the switch.
3. Place the Chassis into the 19-inch wiring closet rail and locate it at the proper position. Then, fix the Chassis by screwing it.

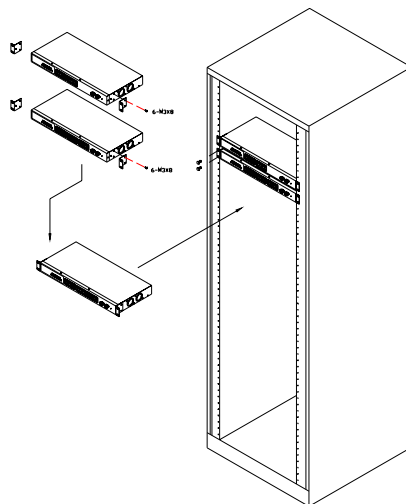

## 1.5.4 Cabling Requirements

To help ensure a successful installation and keep the network performance good, please take a care on the cabling requirement. Cables with worse specification will render the LAN to work poorly.

### Cabling Requirements for TP Ports

*For Fast Ethernet TP network connection*

- The grade of the cable must be Cat. 5 or Cat. 5e with a maximum length of 100 meters.

*Gigabit Ethernet TP network connection*

- The grade of the cable must be Cat. 5 or Cat. 5e with a maximum length of 100 meters. Cat. 5e is recommended.

### Cabling Requirements for SFP Module

It is more complex and comprehensive contrast to TP cabling in the fiber media. Basically, there are two categories of fiber, multi mode (MM) and single mode (SM). The later is categorized into several classes by the distance it supports. They are SX, LX, LHX, XD, and ZX. From the viewpoint of connector type, there mainly are LC and BIDI LC.

- Gigabit Fiber with multi-mode LC SFP module
- Gigabit Fiber with single-mode LC SFP module
- Gigabit Fiber with BiDi LC 1310nm SFP module
- Gigabit Fiber with BiDi LC 1550nm SFP module

The following table lists the types of fiber that we support and those else not listed here are available upon request.

Multi-mode Fiber Cable and Modal Bandwidth				
IEEE 802.3z Gigabit Ethernet 1000SX 850nm	Multi-mode 62.5/125μm		Multi-mode 50/125μm	
	Modal Bandwidth	Distance	Modal Bandwidth	Distance
	160MHz-Km	220m	400MHz-Km	500m
	200MHz-Km	275m	500MHz-Km	550m
1000Base-LX/LH X/XD/ZX	Single-mode Fiber 9/125μm			
	Single-mode transceiver 1310nm		10Km	
	Single-mode transceiver 1550nm		30, 50Km	
1000Base-LX Single Fiber (BIDI LC)	Single-Mode *20Km		TX(Transmit) 1310nm	
			RX(Receive) 1550nm	
	Single-Mode *20Km		TX(Transmit) 1550nm	
			RX(Receive) 1310nm	

## Switch Cascading in Topology

### Takes the Delay Time into Account

Theoretically, the switch partitions the collision domain for each port in switch cascading that you may up-link the switches unlimitedly. In practice, the network extension (cascading levels & overall diameter) must follow the constraint of the IEEE



802.3/802.3u/802.3z and other 802.1 series protocol specifications, in which the limitations are the timing requirement from physical signals defined by 802.3 series specification of Media Access Control (MAC) and PHY, and timer from some OSI layer 2 protocols such as 802.1d, 802.1q, LACP and so on.

The fiber, TP cables and devices' bit-time delay (round trip) are as follows:

<b>1000Base-X TP, Fiber</b>		<b>100Base-TX TP/100Base-FX Fiber</b>			
Round trip Delay: 4096		Round trip Delay: 512			
Cat. 5 TP Wire:	11.12/m	Cat. 5 TP Wire:	1.12/m	Fiber Cable:	1.0/m
Fiber Cable:	10.10/m	TP to fiber Converter: 56			
Bit Time unit: 1ns (1sec./1000 Mega bit)		Bit Time unit: 0.01 $\mu$ s (1sec./100 Mega bit)			

Sum up all elements' bit-time delay and the overall bit-time delay of wires/devices must be within Round Trip Delay (bit times) in a half-duplex network segment (collision domain). For full-duplex operation, this will not be applied. You may use the TP-Fiber module to extend the TP node distance over fiber optic and provide the long haul connection.

### Typical Network Topology in Deployment

A hierarchical network with minimum levels of switch may reduce the timing delay between server and client station. Basically, with this approach, it will minimize the number of switches in any one path; will lower the possibility of network loop and will improve network efficiency. If more than two switches are connected in the same network, select one switch as Level 1 switch and connect all other switches to it at Level 2. Server/Host is recommended to connect to the Level 1 switch. This is general if no VLAN or other special requirements are applied.

#### Case 1: All switch ports are in the same local area network.

Every port can access each other.



If VLAN is enabled and configured, each node in the network that can communicate each other directly is bounded in the same VLAN area.

Here VLAN area is defined by what VLAN you are using. The switch supports both port-based VLAN and tag-based VLAN. They are different in practical deployment, especially in physical location. The following diagram shows how it works and what the difference they are.

### Case 2: Port-based VLAN -1

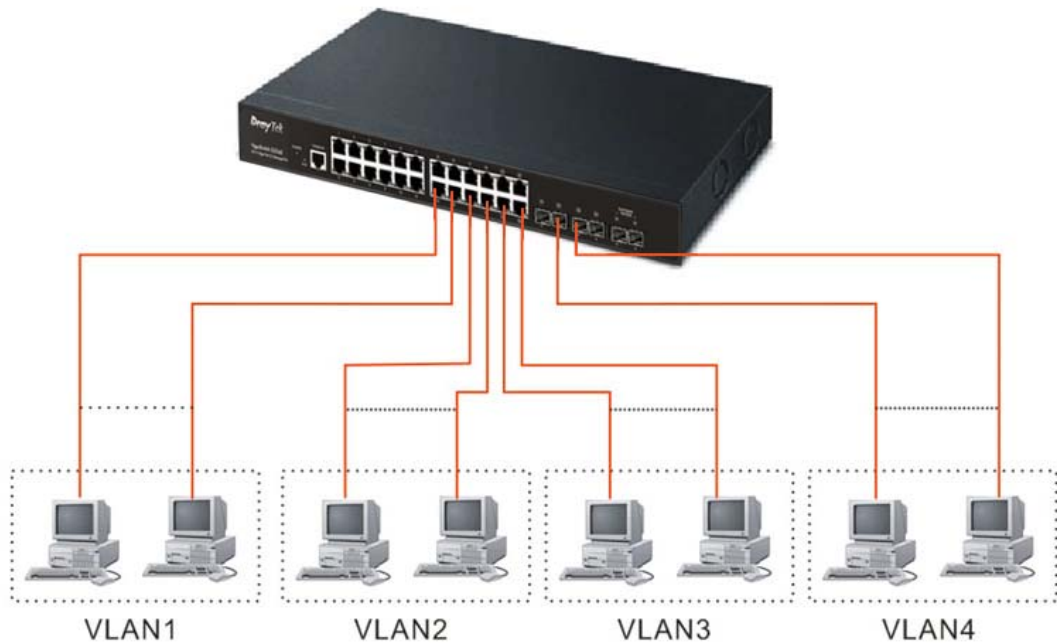

The same VLAN members could not be in different switches.

Every VLAN members could not access VLAN members each other.

The switch manager has to assign different names for each VLAN groups at one switch.

### Case 3: Port-based VLAN – 2

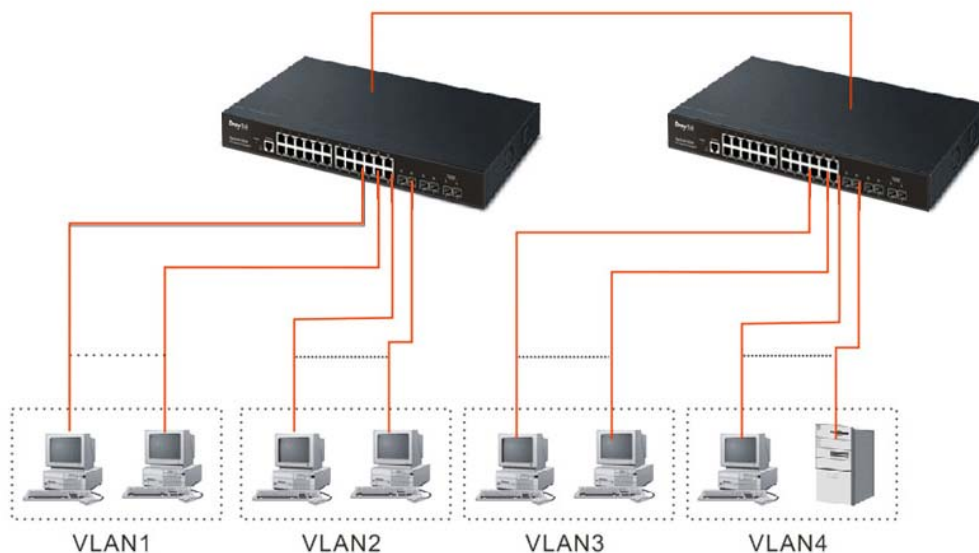

VLAN1 members could not access VLAN2, VLAN3 and VLAN4 members.

VLAN2 members could not access VLAN1 and VLAN3 members, but they could access VLAN4 members.

*VLAN3 members could not access VLAN1, VLAN2 and VLAN4.*

*VLAN4 members could not access VLAN1 and VLAN3 members, but they could access VLAN2 members.*

**Case 4: The same VLAN members can be at different switches with the same VID**

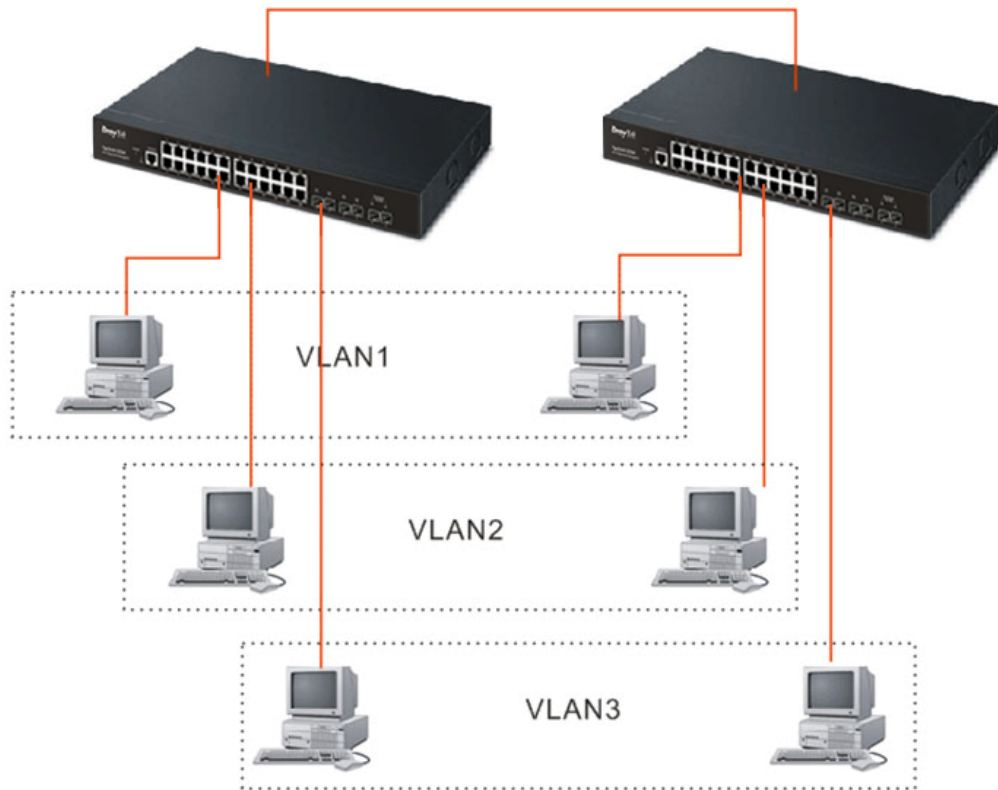

## 1.5.5 Configuring the Management Agent of Switch

VigorSwitch,

For example:

IP=192.168.1.1

Subnet Mask=255.255.255.0

Default Gateway=192.168.1.254

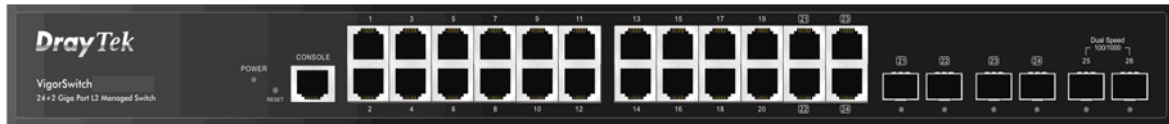

Assign a reasonable IP address,

For example:

IP=192.168.1.100

Subnet Mask=255.255.255.0

Default Gateway=192.168.1.254

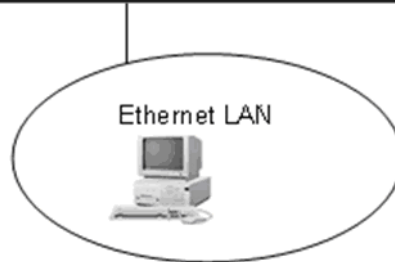

### *Managing VigorSwitch P2261 through Ethernet Port*

Before you communicate with the switch, you have to finish the configuration of the IP address or to know the IP address of the switch. Then, follow the procedures listed below.

1. Set up a physical path between the configured the switch and a PC by a qualified UTP Cat. 5 cable with RJ-45 connector.

**Note:** If PC directly connects to the switch, you have to setup the same subnet mask between them. But, subnet mask may be different for the PC in the remote site.

2. Run web browser and follow the menu. Please refer to Chapter 2.

**DrayTek** VigorSwitch P2261

**Login**

Username

Password





In this diagram, you can see the subnet mask with 25-bit long, 255.255.255.128, contains 126 members in the sub-netted network. Another is that the length of network prefix equals the number of the bit with 1s in that subnet mask. With this, you can easily count the number of IP addresses matched. The following table shows the result.

Prefix Length	No. of IP matched	No. of Addressable IP
/32	1	-
/31	2	-
/30	4	2
/29	8	6
/28	16	14
/27	32	30
/26	64	62
/25	128	126
/24	256	254
/23	512	510
/22	1024	1022
/21	2048	2046
/20	4096	4094
/19	8192	8190
/18	16384	16382
/17	32768	32766
/16	65536	65534

According to the scheme above, a subnet mask 255.255.255.0 will partition a network with the class C. It means there will have a maximum of 254 effective nodes existed in this sub-netted network and is considered a physical network in an autonomous network. So it owns a network IP address which may looks like 168.1.2.0.

With the subnet mask, a bigger network can be cut into small pieces of network. If we want to have more than two independent networks in a worknet, a partition to the network must be performed. In this case, subnet mask must be applied.

For different network applications, the subnet mask may look like 255.255.255.240. This means it is a small network accommodating a maximum of 15 nodes in the network.

**Default gateway:**

For the routed packet, if the destination is not in the routing table, all the traffic is put into the device with the designated IP address, known as default router. Basically, it is a routing policy. The gateway setting is used for Trap Events Host only in the switch.

For assigning an IP address to the switch, you just have to check what the IP address of the network will be connected with the switch. Use the same network address and append your host address to it.

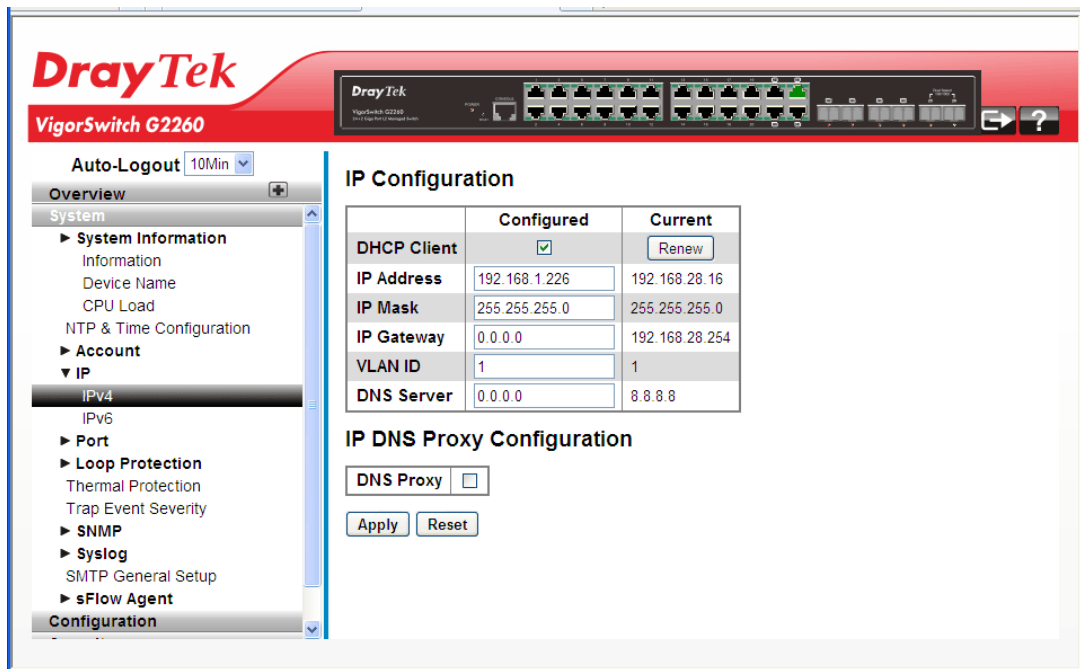

First, IP Address: as shown above, enter “192.168.1.226”, for instance. For sure, an IP address such as 192.168.1.x must be set on your PC.

Second, Subnet Mask: as shown above, enter “255.255.255.0”. Any subnet mask such as 255.255.255.x is allowable in this case.

#### **DNS:**

The Domain Name Server translates human readable machine name to IP address. Every machine on the Internet has a unique IP address. A server generally has a static IP address. To connect to a server, the client needs to know the IP of the server. However, user generally uses the name to connect to the server. Thus, the switch DNS client program (such as a browser) will ask the DNS to resolve the IP address of the named server.



## 1.6 Typical Applications

The 24+2-port Gigabit L2 Managed Switch supported comprehensive fiber types of connection, including LC, BiDi LC for SFP. For more details on the specification of the switch, please refer to Appendix A.

The switch is suitable for the following applications.

- Central Site/Remote site application is used in carrier or ISP

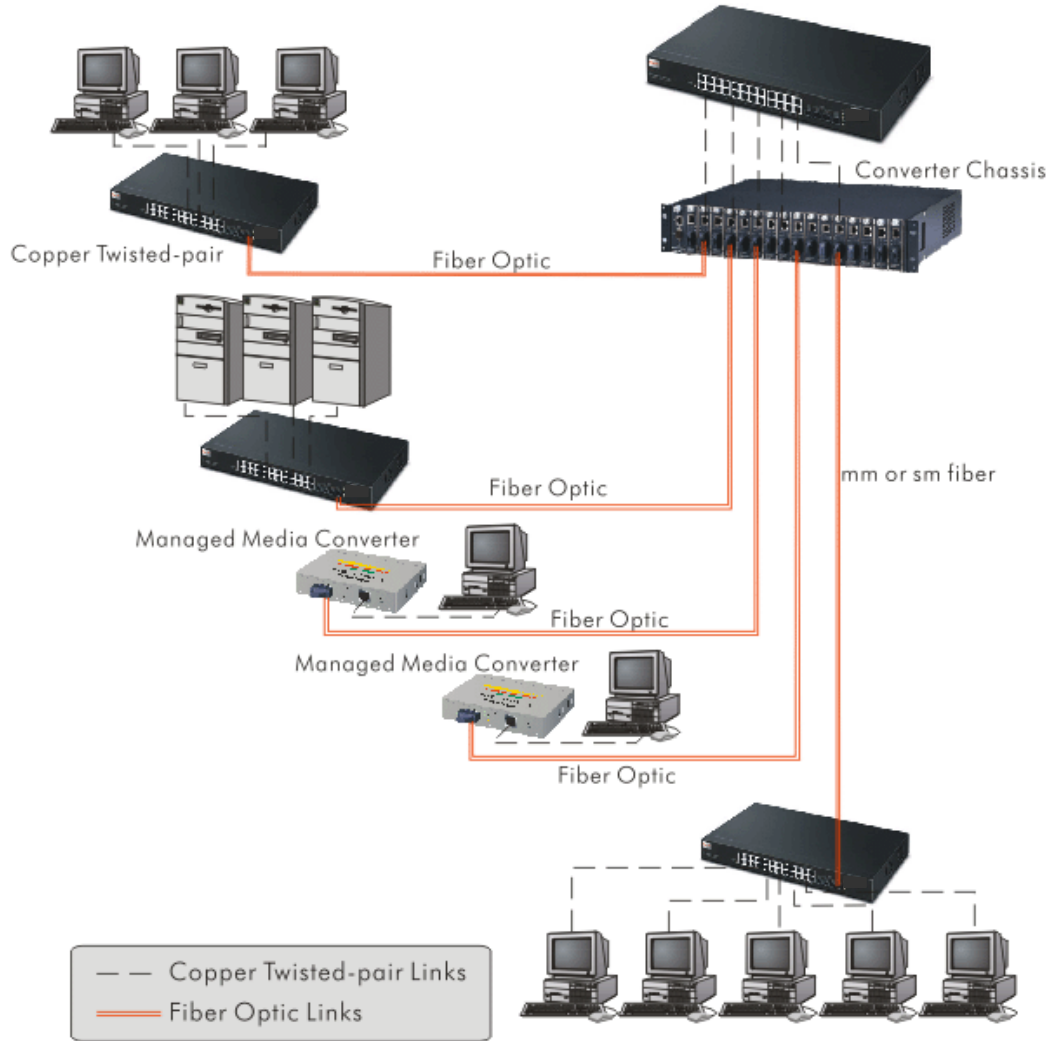

It is a system wide basic reference connection diagram. This diagram demonstrates how the switch connects with other network devices and hosts.

- Peer-to-peer application is used in two remote offices

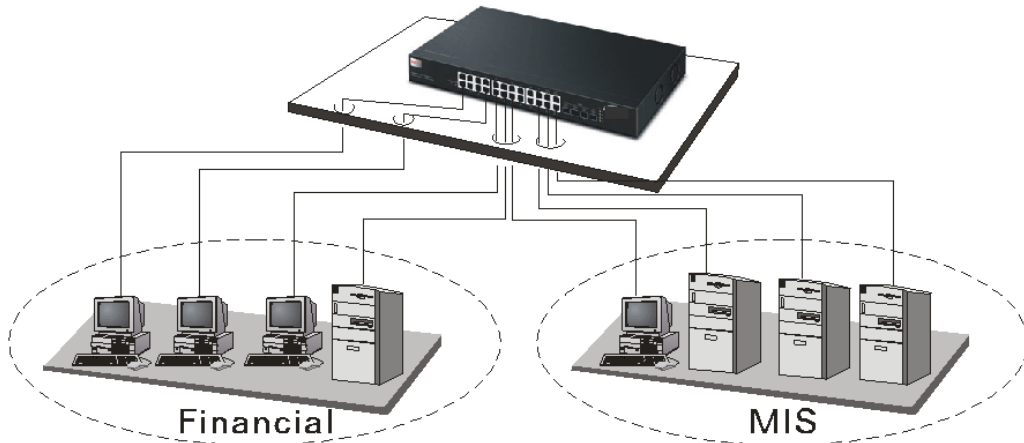

- Office Network Connection

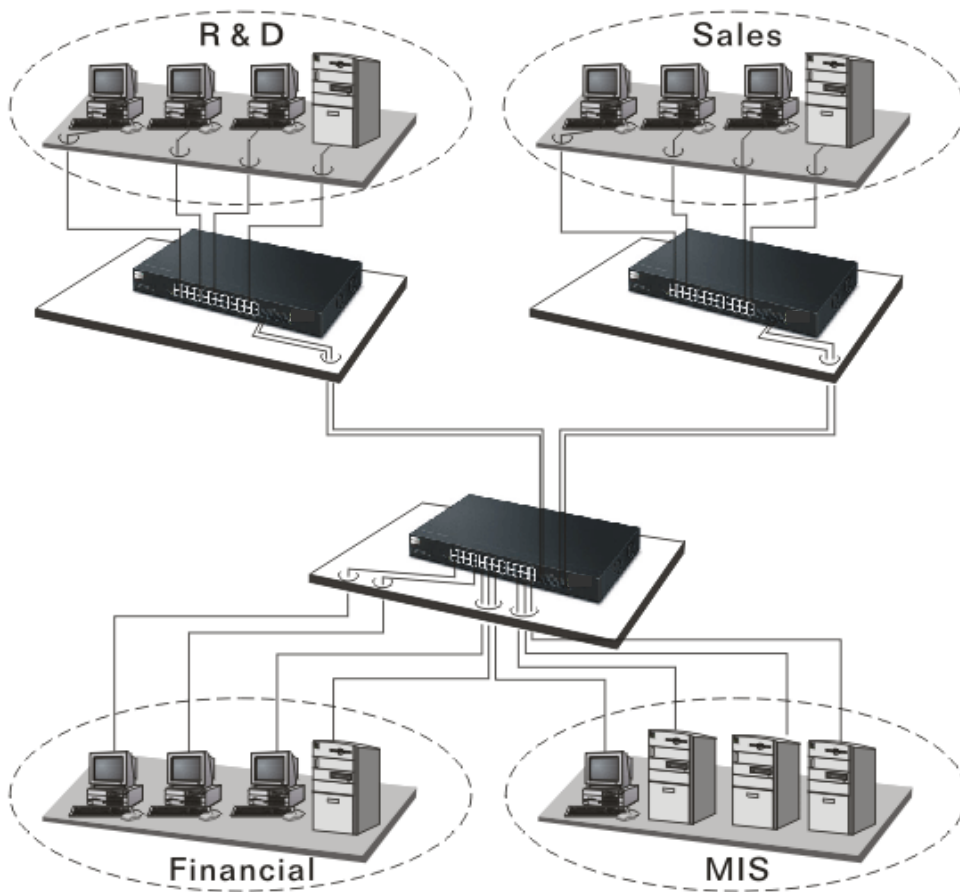

# Chapter 2: Operation of Web-based Management

This chapter instructs you how to configure and manage the switch through the web user interface it supports, to access and manage the switch. With this facility, you can easily access and monitor through any one port of the switch all the status of the switch, including MIBs status, each port activity, Spanning tree status, port aggregation status, multicast traffic, VLAN and priority status, even illegal access record and so on.

The default values of the managed switch are listed in the table below:

<b>IP Address</b>	192.168.1.226
<b>Subnet Mask</b>	255.255.255.0
<b>Default Gateway</b>	0.0.0.0
<b>Username</b>	admin
<b>Password</b>	admin

After the managed switch has been finished configuration in the CLI via the switch's serial interface, you can browse it. For example, type <http://192.168.1.1> in the address row in a browser, it will show the following screen (see Figure below) and ask you inputting username and password in order to login and access authentication. The default username and password are both "admin". For the first time to use, please enter the default username and password, then click the <Login> button. The login process now is completed.

In this login menu, you have to input the complete username and password respectively, the switch will not give you a shortcut to username automatically. This looks inconvenient, but safer.

In the switch, it supports a simple user management function allowing only one administrator to configure the system at the same time. If there are two or more users using administrator's identity, the switch will allow the only one who logs in first to configure the system. The rest of users, even with administrator's identity, can only monitor the system. For those who have no administrator's identity, can only monitor the system. There are only a maximum of three users able to login simultaneously in the switch.

To optimize the display effect, we recommend you use Microsoft IE 6.0 above, Netscape V7.1 above or FireFox V1.00 above and have the resolution 1024x768. The switch supported neutral web browser interface.

**Note:** When you login the switch WEB/CLI to manager, you must type the Username and password first.

**Note:** The default IP of the switch 192.168.1.226.

**Note:** When you login P2261 switch Web UI management, you can use both IPv4 and IPv6 login for management.

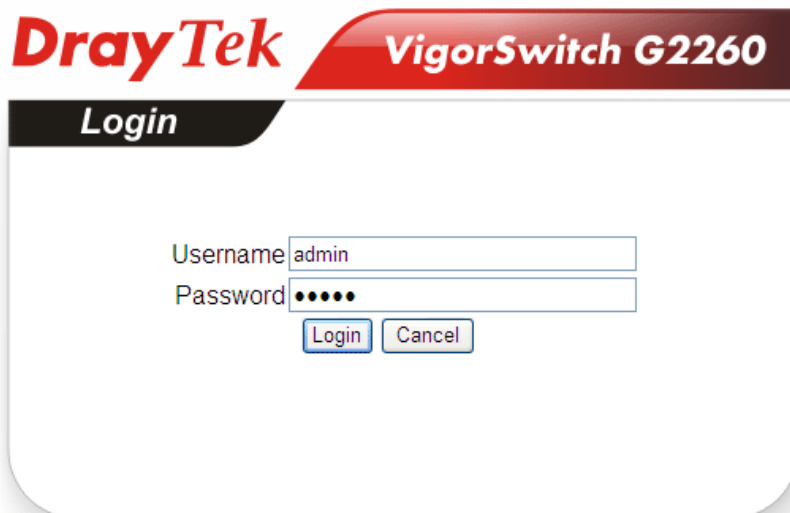

## 2.1 Web Management Home Overview

After you login, the switch shows you the system information as below. This page is default and tells you the basic information of the system, including **“Model Name”**, **“System Description”**, **“Location”**, **“Contact”**, **“Device Name”**, **“System Up Time”**, **“Current Time”**, **“BIOS Version”**, **“Firmware Version”**, **“Hardware-Mechanical Version”**, **“Serial Number”**, **“Host IP Address”**, **“Host MAC Address”**, **“Device Port”**, **“RAM Size”**, **“Flash Size”** and **“CPU Load”**. With this information, you will know the software version used, MAC address, serial number, how many ports good and so on. This is helpful while malfunctioning.

In the following figure, left section is the whole function tree with web user interface and we will travel it through this chapter.

System Information	
Model Name	VigorSwitch P2261
System Description	20-Port 10/100/1000Base-T + 4 TP/(100/1G) SFP Combo + 2 (100/1G) SFP PoE+ L2 Plus Managed Switch
Location	
Contact	
Device Name	P2261
System Date	2011-01-01 02:12:30
System Uptime	0d 02:12:30
BIOS Version	v1.00
Firmware Version	v1.45 2012-09-17
Hardware-Mechanical Version	v1.01-v1.01
Series Code	033A08000007
Host IP Address	10.28.60.21
Subnet Mask	255.255.255.0
Gateway IP Address	10.28.60.254
Host MAC Address	00-50-7F-F0-C0-49
Console Baudrate	115200

## 2.1.1 The Information of Page Layout

On the top side, it shows the front panel of the switch. In the front panel, the linked ports will display green; as to the ports, which are link off, they will be dark. For the optional modules, the slot will show only a cover plate if no module exists and will show a module if a module is present. The image of module depends on the one you inserted. The same, if disconnected, the port will show just dark, if linked, green.

In this device, there are clicking functions on the panel provided for the information of the ports. These are very convenient functions for browsing the information of a single port. When clicking the port on the front panel, an information window for the port will be pop out.

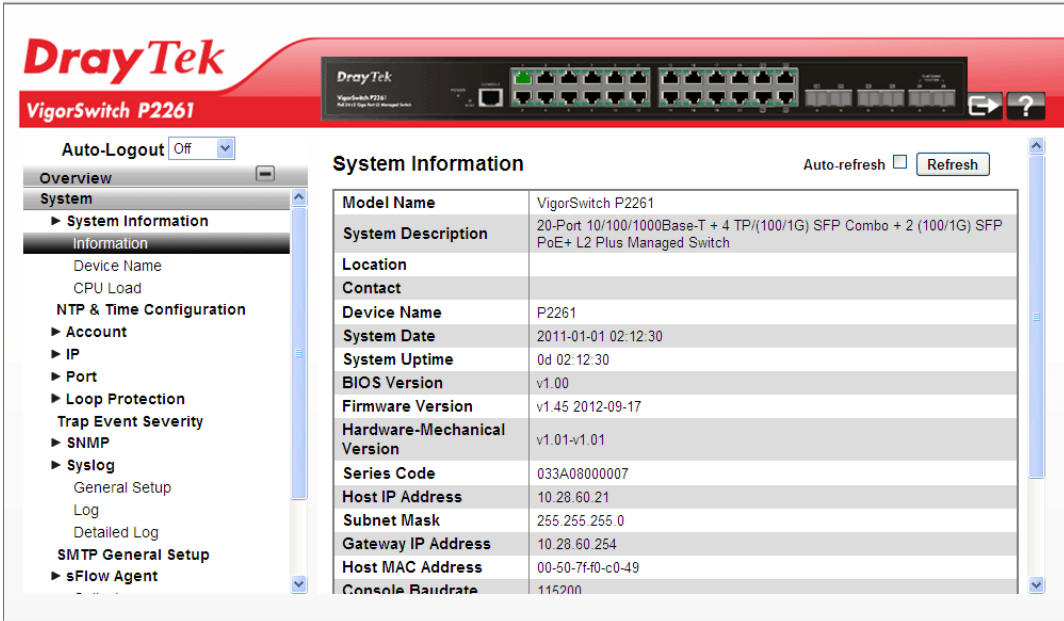

The screenshot displays the web management interface for a DrayTek VigorSwitch P2261. At the top, there is a header with the DrayTek logo and a small image of the switch's front panel. Below the header, there is a navigation menu on the left and a main content area. The main content area is titled "System Information" and contains a table of system details. The "Auto-Logout" function is set to "Off".

Model Name	VigorSwitch P2261
System Description	20-Port 10/100/1000Base-T + 4 TP/(100/1G) SFP Combo + 2 (100/1G) SFP PoE+ L2 Plus Managed Switch
Location	
Contact	
Device Name	P2261
System Date	2011-01-01 02:12:30
System Uptime	0d 02:12:30
BIOS Version	v1.00
Firmware Version	v1.45 2012-09-17
Hardware-Mechanical Version	v1.01-v1.01
Series Code	033A08000007
Host IP Address	10.28.60.21
Subnet Mask	255.255.255.0
Gateway IP Address	10.28.60.254
Host MAC Address	00-50-7f-f0-c0-49
Console Baudrate	115200

It shows the basic information of the clicked port. With this, you'll see the information about the port status, traffic status and bandwidth rating for egress and ingress respectively.

On the left-top corner, there is a pull-down list for Auto Logout. For the sake of security, we provide auto-logout function to protect you from illegal user as you are leaving. If you do not choose any selection in Auto Logout list, it means you turn on the Auto Logout function and the system will be logged out automatically when no action on the device 3 minutes later. If OFF is chosen, the screen will keep as it is. Default is ON.

On the left side, the main menu tree for web is listed in the page. They are hierarchical menu. Open the function folder, a sub-menu will be shown. The functions of each folder are described in its corresponded section respectively. When clicking it, the function is performed. The following list is the full function tree for web user interface.

## 2.2 System

### 2.2.1 System Information - Information

**Function name:**

System Information

**Function description:**

Show the basic system information.

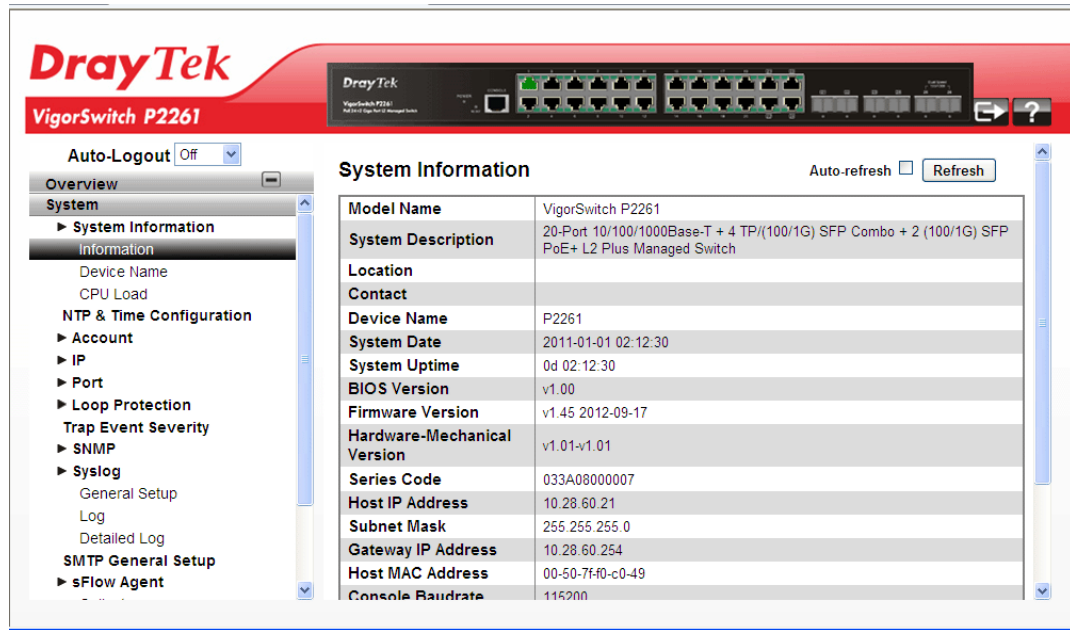

**Parameter description:**

Model name:	The model name of this device.
System description:	Display what the device's description.
Location:	Set the location of the switch where it was located.
Contact:	For easily managing and maintaining device, you may write down the contact person and phone here for getting help soon. You can configure this parameter through the device's user interface or SNMP.
Device name:	The name of the switch, User-defined. Default is VigorSwitch P2261.
System Date	The date that this switch is powered up.
System Uptime:	The time accumulated since this switch is powered up. Its format is day, hour, minute, second.
BIOS version:	The version of the BIOS in this switch
Firmware version:	The firmware version in this switch.
Hardware-Mechanical version:	The version of Hardware and Mechanical. The figure before the hyphen is the version of electronic hardware; the one after the hyphen is the version of mechanical.
Serial Code:	The serial number is assigned by the manufacturer.

Host IP address:	The IP address of the switch.
Subnet Mask:	Displays the IP subnet mask assigned to the device.
Gateway IP Address:	Displays the default gateway IP address assigned to the device.
Host MAC address:	It is the Ethernet MAC address of the management agent in this switch.
Console Baudrate	Displays the baudrate of RS232(COM) port.
RAM size:	The size of the DRAM in this switch.
Flash size:	The size of the flash memory in this switch.
Bridge FDB Size:	Displays the bridge forwarding database size of the device.
Transmit Queue:	Displays the information about the transmit priority queue of switch.
Maximum Frame Size:	Displays the information about switch supported maximum frame size.

## 2.2.2 System Information – Device Name

### Function name:

Device Name

### Function description:

You can identify the system by configuring the contact information, name, and location of the switch.

The screenshot shows the DrayTek web management interface for a VigorSwitch P2261. The 'System Information' section is active, displaying the following details:

Model Name	VigorSwitch P2261
System Description	20-Port 10/100/1000Base-T + 4 TP/(100/1G) SFP Combo + 2 (100/1G) SFP PoE+ L2 Plus Managed Switch
Location	
Contact	
Device Name	P2261
System Date	2011-01-01 02:12:30
System Uptime	0d 02:12:30
BIOS Version	v1.00
Firmware Version	v1.45 2012-09-17
Hardware-Mechanical Version	v1.01-v1.01
Series Code	033A08000007
Host IP Address	10.28.60.21
Subnet Mask	255.255.255.0
Gateway IP Address	10.28.60.254
Host MAC Address	00-50-7F-F0-C0-49
Console Baudrate	115200

### Parameter description:

System Contact	The textual identification of the contact person for this managed node, together with information on how to contact this person. The allowed string length is 0 to 255, and the allowed content is the ASCII characters from 32 to 126.
----------------	---

System Name	An administratively assigned name for this managed node. By convention, this is the node's fully-qualified domain name. A domain name is a text string drawn from the alphabet (A-Za-z), digits (0-9), minus sign (-). No space characters are permitted as part of a name. The first character must be an alpha character. And the first or last character must not be a minus sign. The allowed string length is 0 to 255.
System Location	The physical location of this node(e.g., telephone closet, 3rd floor). The allowed string length is 0 to 255, and the allowed content is the ASCII characters from 32 to 126.

After finished the above settings, click **Apply** to save the configuration.

### 2.2.3 System Information – CPU Load

**Function name:**

CPU Load

**Function description:**

This page displays the CPU load, using an SVG graph.

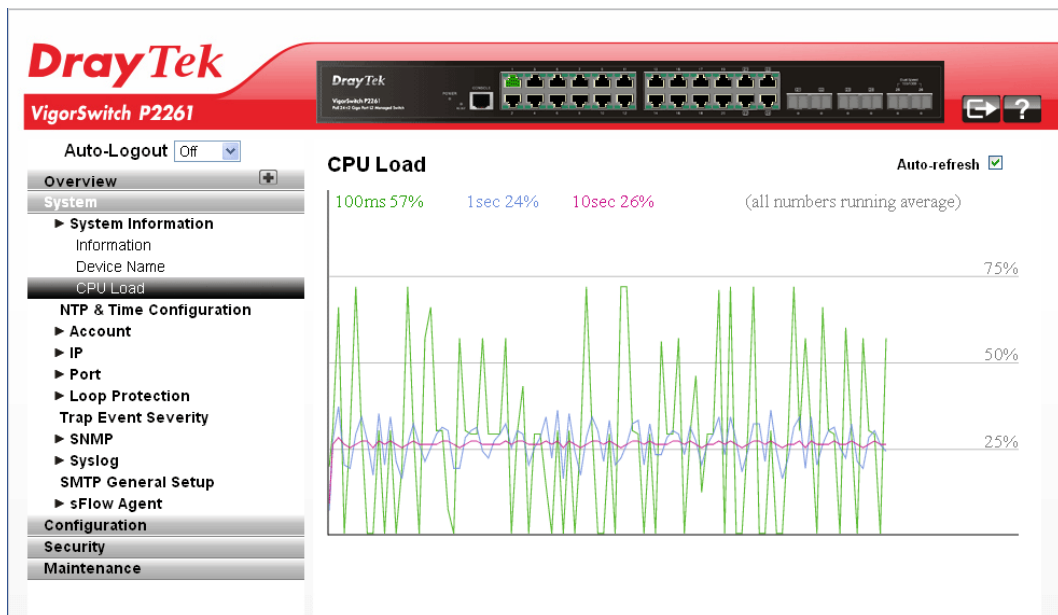

The load is measured as averaged over the last 100ms, 1sec and 10 seconds intervals. The last 120 samples are graphed, and the last numbers are displayed as text as well.

In order to display the SVG graph, **your browser must support the SVG format.** Consult the SVG Wiki for more information on browser support. Specifically, at the time of writing, Microsoft Internet Explorer will need to have a plug-in installed to support SVG.

**Note:** CPU Load is using SVG (Scalable Vector Graphics) to display the chart and this feature is only available on MS IE 9.0 & above or Firefox v4.0 & above.



## 2.2.4 NTP & Time Configuration

### Function name:

NTP & Time Configuration

### Function description:

This page configures the switch Time. Time configure is including Time Configuration and NTP Configuration.

The switch provides manual and automatic ways to set the system time via NTP. Manual setting is simple and you just input “Year”, “Month”, “Day”, “Hour”, “Minute” and “Second” within the valid value range indicated in each item.

### Parameter description:

Clock Source	<p>There are two modes for configuring where the Clock Source is from. You can choose one of them to make time setting.</p> <ol style="list-style-type: none"> <li>1. Use Local Settings: In this mode Clock Source is from Local Time. Set the time manually.</li> <li>2. Use NTP Server: In this mode Clock Source is from NTP Server. The switch can link to Network Time Protocol server to obtain the correct time automatically when NTP server has been set.</li> </ol>
Local Time	Show the current time of the system.
Time Zone Offset / Time Set Offset	Provide the time zone offset relative to UTC/GMT. The offset is given in minutes east of GMT. The valid range is from -720 to 720 minutes.
Daylight Saving	Daylight saving is adopted in some countries. If set, it will adjust the time lag or in advance in unit of hours, according to the starting date and the ending date. For example, if you set the day light saving to be 1 hour. When the time passes over the starting time, the system time will be increased one hour after one minute at the time since it passed over.

	<p>And when the time passes over the ending time, the system time will be decreased one hour after one minute at the time since it passed over.</p> <p>The switch supports valid configurable day light saving time is <math>-5 \sim +5</math> step one hour. The zero for this parameter means it need not have to adjust current time, equivalent to in-act daylight saving. You don't have to set the starting/ending date as well. If you set daylight saving to be non-zero, you have to set the starting/ending date as well; otherwise, the daylight saving function will not be activated.</p> <p>Default for Daylight Saving: 0.</p> <p>The following parameters are configurable for the function Daylight Saving and described in detail.</p> <p>Day Light Saving Start:</p> <p>This is used to set when to start performing the day light saving time.</p> <p>Month:            Range is 1 ~ 12.        Default: 1  Day:                Range is 1 ~ 31.         Default: 1  Hour:              Range is 0 ~ 23.        Default: 0</p> <p>Day Light Saving End:</p> <p>This is used to set when to stop performing the daylight saving time.</p> <p>Month:            Range is 1 ~ 12.        Default: 1  Day:                Range is 1 ~ 31.         Default: 1  Hour:              Range is 0 ~ 23.        Default: 0</p>
NTP Configuration	<p>NTP is Network Time Protocol and is used to sync the network time based Greenwich Mean Time (GMT). If use the NTP mode and select a built-in NTP time server or manually specify an user-defined NTP server as well as Time Zone, the switch will sync the time in a short after pressing &lt;Apply&gt; button. Though it synchronizes the time automatically, NTP does not update the time periodically without user's processing.</p> <p>Time Zone is an offset time off GMT. You have to select the time zone first and then perform time sync via NTP because the switch will combine this time zone offset and updated NTP time to come out the local time, otherwise, you will not able to get the correct time. The switch supports configurable time zone from <math>-12</math> to <math>+13</math> step 1 hour.</p> <p>Default Time zone: +8 Hrs.</p>

### 2.2.5 Account - Users

In this function, only administrator can create, modify or delete the username and password. Administrator can modify other guest identities' password without confirming the password but it is necessary to modify the administrator-equivalent identity. Guest-equivalent identity can modify his password only. Please note that you must confirm

administrator/guest identity in the field of Authorization in advance before configuring the username and password. Only one administrator is allowed to exist and unable to be deleted. In addition, up to 4 guest accounts can be created.

The default setting for user account is:

Username: admin

Password: admin

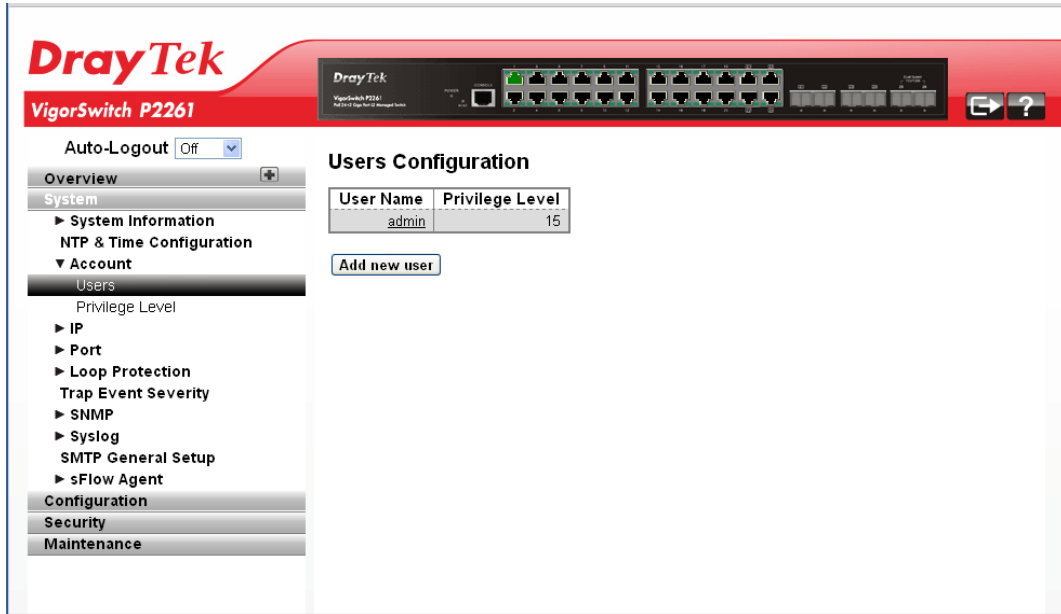

**Parameter description:**

User Name	The name identifying the user. This is also a link to edit the user.								
Privilege Level	The privilege level of the user. The allowed range is 1 to 15. If the privilege level value is 15, it can access all groups, i.e. that is granted the fully control of the device. But others value need to refer to each group privilege level. User's privilege should be same or greater than the group privilege level to have the access of that group. By default setting, most groups privilege level 5 has the read-only access and privilege level 10 has the read-write access. And the system maintenance (software upload, factory defaults and etc.) need user privilege level 15. Generally, the privilege level 15 can be used for an administrator account, privilege level 10 for a standard user account and privilege level 5 for a guest account.								
Add new user	Create a new user account. <b>Add User</b> <div style="border: 1px solid gray; padding: 5px; margin: 5px 0;"> <p style="text-align: center; margin: 0;"><b>User Settings</b></p> <table style="width: 100%; border-collapse: collapse;"> <tr> <td style="width: 30%;"><b>User Name</b></td> <td><input style="width: 90%;" type="text"/></td> </tr> <tr> <td><b>Password</b></td> <td><input style="width: 90%;" type="password"/></td> </tr> <tr> <td><b>Password (again)</b></td> <td><input style="width: 90%;" type="password"/></td> </tr> <tr> <td><b>Privilege Level</b></td> <td><input style="width: 90%;" type="text" value="1"/> <span style="float: right;">▼</span></td> </tr> </table> <p style="text-align: center; margin: 0;"> <input type="button" value="Apply"/> <input type="button" value="Reset"/> <input type="button" value="Cancel"/> </p> </div>	<b>User Name</b>	<input style="width: 90%;" type="text"/>	<b>Password</b>	<input style="width: 90%;" type="password"/>	<b>Password (again)</b>	<input style="width: 90%;" type="password"/>	<b>Privilege Level</b>	<input style="width: 90%;" type="text" value="1"/> <span style="float: right;">▼</span>
<b>User Name</b>	<input style="width: 90%;" type="text"/>								
<b>Password</b>	<input style="width: 90%;" type="password"/>								
<b>Password (again)</b>	<input style="width: 90%;" type="password"/>								
<b>Privilege Level</b>	<input style="width: 90%;" type="text" value="1"/> <span style="float: right;">▼</span>								

	<p><b>User Name</b> – The name identifying the user. This is also a link to Add/Edit User.</p> <p>A string identifying the user name that this entry should belong to. The allowed string length is 1 to 32. The valid user name is a combination of letters, numbers and underscores.</p> <p><b>Password</b> – Type a password of the user. The allowed string length is 0 to 255, and the allowed content is the ASCII characters from 32 to 126.</p> <p><b>Password (again)</b> – Type the new password again to confirm the setting.</p> <p><b>Privilege Level</b> - The privilege level of the user. The allowed range is 1 to 15. If the privilege level value is 15, it can access all groups, i.e. that is granted the fully control of the device. But others value need to refer to each group privilege level. User's privilege should be same or greater than the group privilege level to have the access of that group. By default setting, most groups privilege level 5 has the read-only access and privilege level 10 has the read-write access. And the system maintenance (software upload, factory defaults and etc.) need user privilege level 15. Generally, the privilege level 15 can be used for an administrator account, privilege level 10 for a standard user account and privilege level 5 for a guest account.</p> <p><b>Note:</b> You can add more user name up to 19 set in Users configuration. You can configure 20 set of user name totally including admin account.</p> <p>After finished the above settings, click <b>Apply</b> to save the configuration.</p>
--	---

## 2.2.6 Account – Privilege Level

**Function name:**

Privilege Level

**Function description:**

This page provides an overview of the privilege levels. The switch provides user set Account, Aggregation, Diagnostics, EEE, GARP, GVRP, IP, IPMC Snooping LACP LLDP LLDP MED MAC Table MRP MVR MVRP Maintenance Mirroring POE Ports Private VLANs QoS SMTP SNMP Security Spanning Tree System Trap Event VCL VLANs Voice VLAN Privilege Levels form 1 to 15 .

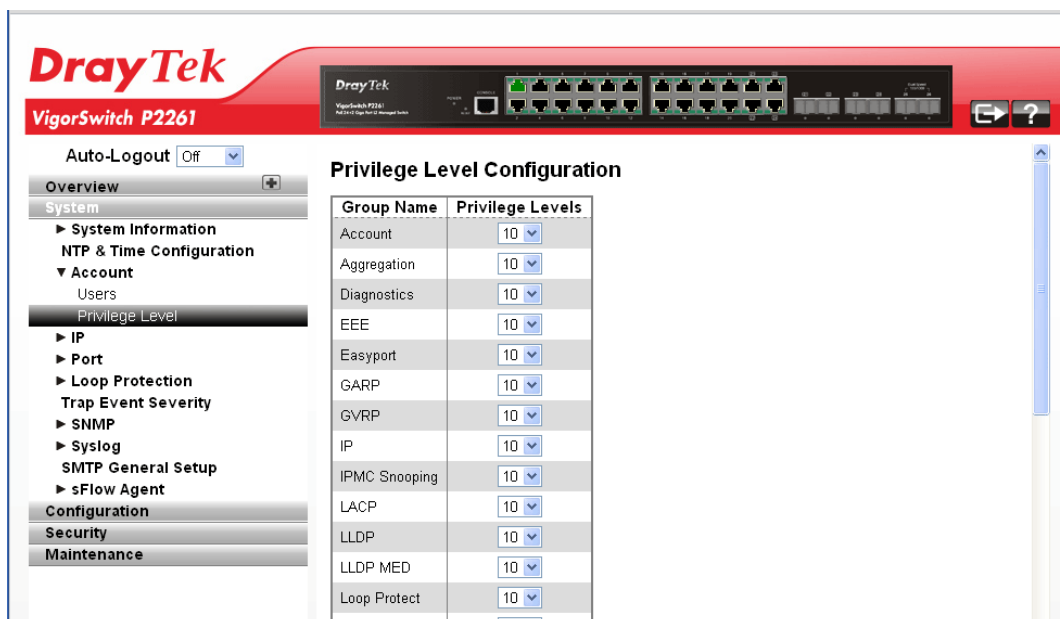

### Parameter description:

Group Name	The name identifying the privilege group. In most cases, a privilege level group consists of a single module (e.g. LACP, RSTP or QoS), but a few of them contains more than one.
Privilege Levels	Every group has an authorization Privilege level.

After finished the above settings, click **Apply** to save the configuration.

## 2.2.7 IP Configuration – IPv4

IP is an acronym for Internet Protocol. It is a protocol used for communicating data across an internet network.

IP is a "best effort" system, which means that no packet of information sent over is assured to reach its destination in the same condition it was sent. Each device connected to a Local Area Network (LAN) or Wide Area Network (WAN) is given an Internet Protocol address, and this IP address is used to identify the device uniquely among all other devices connected to the extended network.

The current version of the Internet protocol is IPv4, which has 32-bits Internet Protocol addresses allowing for in excess of four billion unique addresses. This number is reduced drastically by the practice of webmasters taking addresses in large blocks, the bulk of which remain unused. There is a rather substantial movement to adopt a new version of the Internet Protocol, IPv6, which would have 128-bits Internet Protocol addresses. This number can be represented roughly by a three with thirty-nine zeroes after it. However, IPv4 is still the protocol of choice for most of the Internet.

### Function name:

IPv4

### Function description:

The IPv4 address for the switch could be obtained via DHCP Server for VLAN 1. To manually configure an address, you need to change the switch's default settings to values that are compatible with your network. You may also need to establish a default gateway between the switch and management stations that exist on another network segment.

Configure the switch-managed IP information on this page.

- The Configured column is used to view or change the IP configuration.
- The Current column is used to show the active IP configuration.

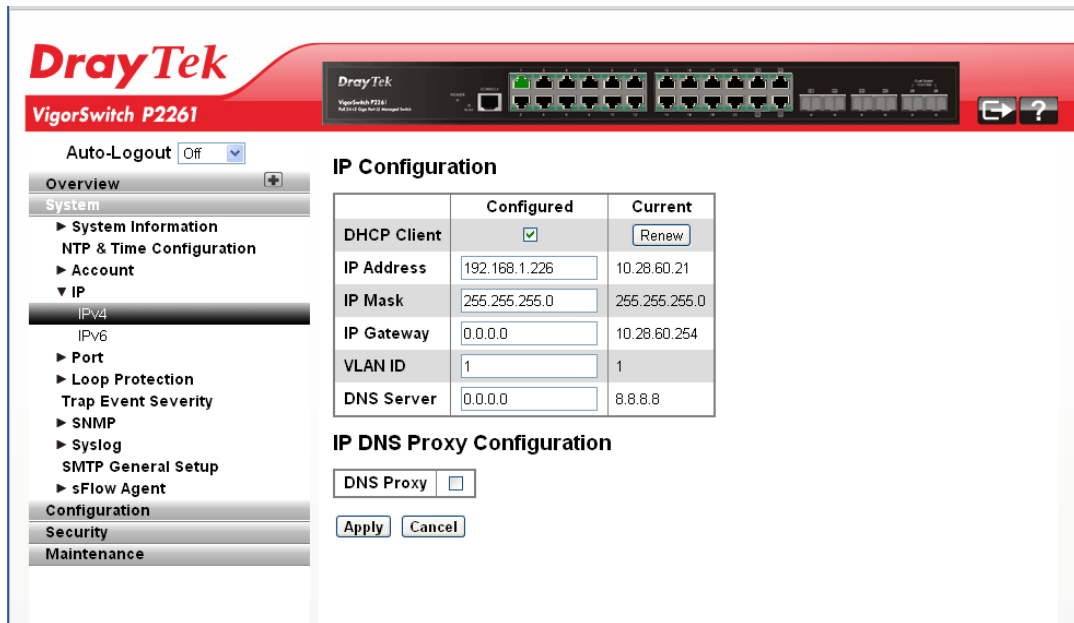

**Parameter description:**

DHCP Client	Enable the DHCP client by checking this box. If DHCP fails and the configured IP address is zero, DHCP will retry. If DHCP fails and the configured IP address is non-zero, DHCP will stop and the configured IP settings will be used. The DHCP client will announce the configured System Name as hostname to provide DNS lookup.
IP Address	Provide the IP address of this switch in dotted decimal notation.
IP Mask	Provide the IP mask of this switch dotted decimal notation.
IP Gateway	Provide the IP address of the router in dotted decimal notation.
SNTP Server	Provide the IP address of the SNTP Server in dotted decimal notation.
DNS Server	Provide the IP address of the DNS Server in dotted decimal notation.
VLAN ID	Provide the managed VLAN ID. The allowed range is 1 to 4095.
DNS Proxy	When DNS proxy is enabled, DUT will relay DNS requests to the current configured DNS server on DUT, and reply as a DNS resolver to the client device on the network.

After finished the above settings, click **Apply** to save the configuration.

**2.2.8 IP Configuration – IPv6**

**Function name:**

IPv6

**Function description:**

Describe how to configure the switch-managed IPv6 information. The Configured column is used to view or change the IPv6 configuration. And the Current column is used to show the active IPv6 configuration.

Configure the switch-managed IP information on this page.

- The Configured column is used to view or change the IP configuration.
- The Current column is used to show the active IP configuration.

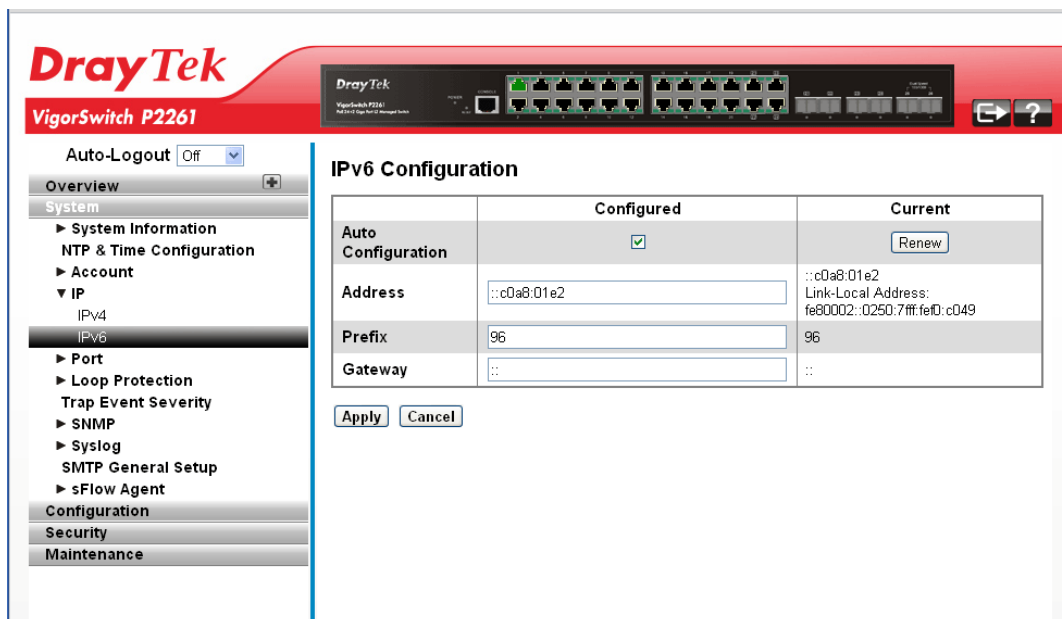
**Parameter description:**

Auto Configuration	Enable IPv6 auto-configuration by checking this box. If fails, the configured IPv6 address is zero. The router may delay responding to a router solicitation for a few seconds, the total time needed to complete auto-configuration can be significantly longer.
Address	Provide the IPv6 address of this switch. IPv6 address is in 128-bit records represented as eight fields of up to four hexadecimal digits with a colon separating each field (:). For example, 'fe80::215:c5ff:fe03:4dc7'. The symbol '::' is a special syntax that can be used as a shorthand way of representing multiple 16-bit groups of contiguous zeros; but it can only appear once. It can also represent a legally valid IPv4 address. For example, '::192.1.2.34'.
Prefix	Provide the IPv6 Prefix of this switch. The allowed range is 1 to 128.
Gateway	Provide the IPv6 gateway address of this switch. IPv6 address is in 128-bit records represented as eight fields of up to four hexadecimal digits with a colon separating each field (:). For example, 'fe80::215:c5ff:fe03:4dc7'. The symbol '::' is a special syntax that can be used as a

shorthand way of representing multiple 16-bit groups of contiguous zeros; but it can only appear once. It can also represent a legally valid IPv4 address. . For example, '::192.1.2.34'.

After finished the above settings, click **Apply** to save the configuration.

## 2.2.9 Port – General Setup

Port configuration is applied to change the setting of each port. In this configuration function, you can set/reset the following functions. All of them are described in detail below.

### Function name:

General Setup

### Function description:

It describes how to view the current port configuration and how to configure ports to non-default settings, including Linkup/Linkdown, Speed (Current and Type), Flow Control (Current Rx, Current Tx and Enabled), Maximum Frame Size, Excessive Collision Mode and Power Control.

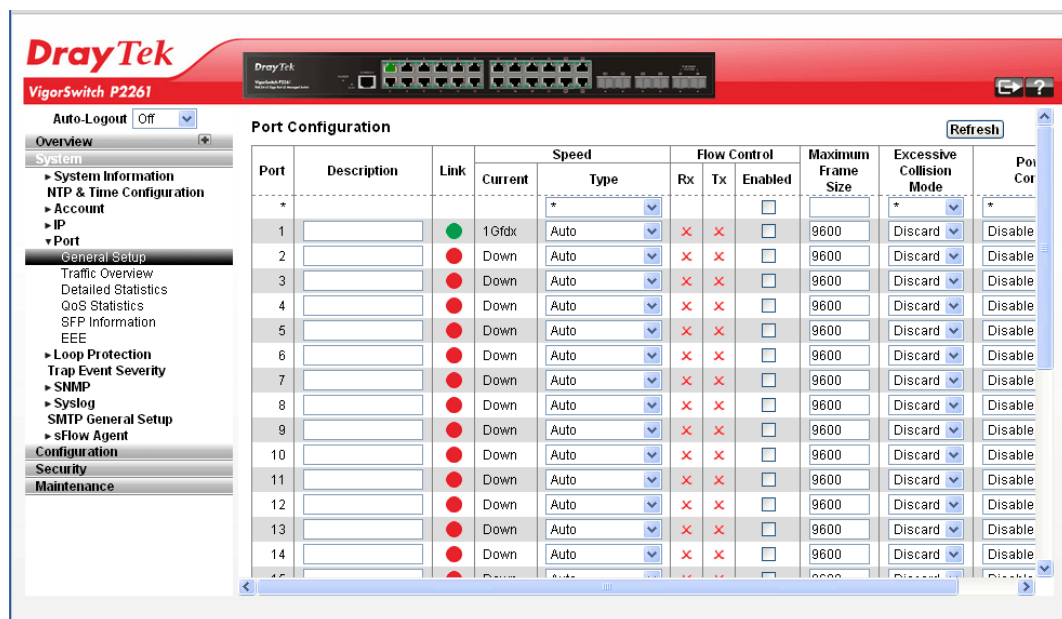

### Parameter description:

Port	This is the logical port number for this row.
Description	It describes to configure the Port's alias or any descriptions for the Port Identity. It provides user to write down an alphanumeric string describing the full name and version identification for the system's hardware type, software version, and networking application
Link	The current link state is displayed graphically. Green indicates the link is up and red that it is down.
Speed	Current - Provides the current link speed of the port. Type - Set the speed and duplex of the port. In speed, if the

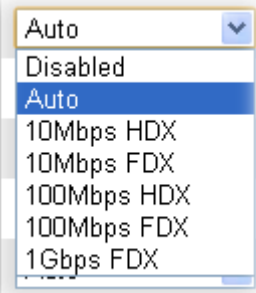

	<p>media is 1Gbps fiber, it is always 1000Mbps and the duplex is full only. If the media is TP, the Speed/Duplex is comprised of the combination of speed mode, 10/100/1000Mbps, and duplex mode, full duplex and half duplex. The following table summarized the function the media supports.</p>  <p>In Auto mode, no default value. In Forced mode, default value depends on your setting.</p>
Flow Control	<p>When Auto Speed is selected on a port, this section indicates the flow control capability that is advertised to the link partner. When a fixed-speed setting is selected, that is what is used. The Current Rx column indicates whether pause frames on the port are obeyed, and the Current Tx column indicates whether pause frames on the port are transmitted. The Rx and Tx settings are determined by the result of the last Auto-Negotiation.</p> <p>Check the configured column to use flow control. This setting is related to the setting for Configured Link Speed.</p>
Maximum Frame Size	<p>This module offers 1518~9600 (Bytes) length to make the long packet.</p>
Excessive Collision Mode	<p>There are two modes to choose when excessive collision happened in half-duplex condition as below:</p> <p>Discard - The “Discard” mode determines whether the MAC drop frames after an excessive collision has occurred. If yes, a frame is dropped after excessive collision. This is IEEE Standard 802.3 half-duplex flow control operation.</p> <p>Restart - The “Restart” mode determines whether the MAC retransmits frames after an excessive collision has occurred. If set, a frame is not dropped after excessive collisions, but the backoff sequence is restarted. This is a violation of IEEE Standard 802.3, but is useful in non-dropping half-duplex flow control operation.</p>
Power Control	<p>The Usage column shows the current percentage of the power consumption per port. The Configured column allows for changing the power savings mode parameters per port.</p> <p>Disabled: All power savings mechanisms disabled.</p> <p>ActiPHY: Link down power savings enabled.</p> <p>PerfectReach: Link up power savings enabled.</p>

Enabled: Both link up and link down power savings enabled.

After finished the above settings, click **Apply** to save the configuration.

## 2.2.10 Port – Traffic Overview

**Function name:**

Traffic Overview

**Function Description:**

It describes to the Port statistics information and provides overview of general traffic statistics for all switch ports. The ports belong to the currently selected stack unit, as reflected by the page header

Port	Packets		Bytes		Errors		Drops		Filtered
	Received	Transmitted	Received	Transmitted	Received	Transmitted	Received	Transmitted	
1	6680	2390	1672553	1015955	0	0	0	0	3146
2	0	0	0	0	0	0	0	0	0
3	0	0	0	0	0	0	0	0	0
4	0	0	0	0	0	0	0	0	0
5	0	0	0	0	0	0	0	0	0
6	0	0	0	0	0	0	0	0	0
7	0	0	0	0	0	0	0	0	0
8	0	0	0	0	0	0	0	0	0
9	0	0	0	0	0	0	0	0	0
10	0	0	0	0	0	0	0	0	0
11	0	0	0	0	0	0	0	0	0
12	0	0	0	0	0	0	0	0	0
13	0	0	0	0	0	0	0	0	0
14	0	0	0	0	0	0	0	0	0
15	0	0	0	0	0	0	0	0	0
16	0	0	0	0	0	0	0	0	0
17	0	0	0	0	0	0	0	0	0
18	0	0	0	0	0	0	0	0	0
19	0	0	0	0	0	0	0	0	0
20	0	0	0	0	0	0	0	0	0
21	0	0	0	0	0	0	0	0	0
22	0	0	0	0	0	0	0	0	0
23	0	0	0	0	0	0	0	0	0

**Parameter Description:**

Port	Display the port number. The number is 1 – 24. Both port 21 ~ 24 are optional modules.
Packets	The number of received and transmitted packets per port.
Bytes	The number of received and transmitted bytes per port.
Errors	The number of frames received in error and the number of incomplete transmissions per port.
Drops	The number of frames discarded due to ingress or egress congestion.
Filtered	The number of received frames filtered by the forwarding.
Auto refresh	The simple counts will be refreshed automatically on the UI screen.
Refresh	The simple counts will be refreshed manually when user use mouse to click on “Refresh” button.
Clear	The simple counts will be reset to zero when user use mouse to click on “Clear” button.

## 2.2.11 Port - Detailed Statistics

The section describes how to provide detailed traffic statistics for a specific switch port. Use the port select box to select which switch port details to display. The selected port belongs to the currently selected stack unit, as reflected by the page header.

### Function name:

Detailed Statistics

### Function description:

The displayed counters are the totals for receive and transmit, the size counters for receive and transmit, and the error counters for receive and transmit.

Receive Total		Transmit Total	
Rx Packets	6792	Tx Packets	2455
Rx Octets	1703056	Tx Octets	1043962
Rx Unicast	2716	Tx Unicast	2368
Rx Multicast	2669	Tx Multicast	83
Rx Broadcast	1407	Tx Broadcast	4
Rx Pause	0	Tx Pause	0
Receive Size Counters		Transmit Size Counters	
Rx 64 Bytes	2697	Tx 64 Bytes	132
Rx 65-127 Bytes	429	Tx 65-127 Bytes	418
Rx 128-255 Bytes	397	Tx 128-255 Bytes	658
Rx 256-511 Bytes	2768	Tx 256-511 Bytes	624
Rx 512-1023 Bytes	501	Tx 512-1023 Bytes	28
Rx 1024-1526 Bytes	0	Tx 1024-1526 Bytes	595
Rx 1527-Bytes	0	Tx 1527-Bytes	0
Receive Queue Counters		Transmit Queue Counters	
Rx Q0	6792	Tx Q0	0
Rx Q1	0	Tx Q1	0
Rx Q2	0	Tx Q2	0
Rx Q3	0	Tx Q3	0
Rx Q4	0	Tx Q4	0
Rx Q5	0	Tx Q5	0
Rx Q6	0	Tx Q6	0
Rx Q7	0	Tx Q7	2455

### Parameter description:

#### Receive Total and Transmit Total

Rx and Tx Packets	The number of received and transmitted (good and bad) packets.
Rx and Tx Octets	The number of received and transmitted (good and bad) bytes. Includes FCS, but excludes framing bits.
Rx and Tx Unicast	The number of received and transmitted (good and bad) unicast packets.
Rx and Tx Multicast	The number of received and transmitted (good and bad) multicast packets.
Rx and Tx Broadcast	The number of received and transmitted (good and bad) broadcast packets.
Rx and Tx Pause	A count of the MAC Control frames received or transmitted on this port that have an opcode indicating a PAUSE operation.

#### Receive and Transmit Size Counters

The number of received and transmitted (good and bad) packets split into categories

---

based on their respective frame sizes.

---

### Receive and Transmit Queue Counters

The number of received and transmitted packets per input and output queue.

RX 64 Bytes	Number of 64-byte frames in good and bad packets received.
RX 65-127 Bytes	Number of 65 ~ 127-byte frames in good and bad packets received.
RX 128-255 Bytes	Number of 128 ~ 255-byte frames in good and bad packets received.
RX 256-511 Bytes	Number of 256 ~ 511-byte frames in good and bad packets received.
RX 512-1023 Bytes	Number of 512 ~ 1023-byte frames in good and bad packets received.
RX 1024- 1522 Bytes	Number of 1024-1522-byte frames in good and bad packets received.
RX 1527 Bytes	Number of 1527-byte frames in good and bad packets received.

### Receive Error Counters

Rx Drops	The number of frame dropped due to lack of received buffers or egress congestion.
Rx CRC/Alignment	The number of frames received with CRC or alignment errors.
Rx Undersize	The number of short 1 frames received with valid CRC.
Rx Oversize	The number of long 2 frames received with valid CRC.
Rx Fragments	The number of short 1 frame received with invalid CRC.
Rx Jabber	The number of long 2 frames received with invalid CRC.
Rx Filtered	The number of received frames filtered by the forwarding process. Short frames are frames that are smaller than 64 bytes. Long frames are frames that are longer than the configured maximum frame length for this port.

### Transmit Error Counters

Tx Drops	The number of frames dropped due to output buffer congestion.
Tx Late/Exc. Coll.	The number of frames dropped due to excessive or late collisions.

---

## 2.2.12 Port - QoS Statistics

The section describes that switch could display the QoS detailed Queuing counters for a specific switch port. for the different queues for all switch ports. The ports belong to the currently selected stack unit, as reflected by the page header.

**Function name:**

## QoS Statistics

### Function description:

The displayed counters are the totals for receive and transmit, the size counters for receive and transmit, and the error counters for receive and transmit.

Port	Q0		Q1		Q2		Q3		Q4		Q5		Q6		Q7		
	Rx	Tx	Rx	Tx	Rx	Tx	Rx	Tx	Rx	Tx	Rx	Tx	Rx	Tx	Rx	Tx	
1	6960	0	0	0	0	0	0	0	0	0	0	0	0	0	0	0	2569
2	0	0	0	0	0	0	0	0	0	0	0	0	0	0	0	0	0
3	0	0	0	0	0	0	0	0	0	0	0	0	0	0	0	0	0
4	0	0	0	0	0	0	0	0	0	0	0	0	0	0	0	0	0
5	0	0	0	0	0	0	0	0	0	0	0	0	0	0	0	0	0
6	0	0	0	0	0	0	0	0	0	0	0	0	0	0	0	0	0
7	0	0	0	0	0	0	0	0	0	0	0	0	0	0	0	0	0
8	0	0	0	0	0	0	0	0	0	0	0	0	0	0	0	0	0
9	0	0	0	0	0	0	0	0	0	0	0	0	0	0	0	0	0
10	0	0	0	0	0	0	0	0	0	0	0	0	0	0	0	0	0
11	0	0	0	0	0	0	0	0	0	0	0	0	0	0	0	0	0
12	0	0	0	0	0	0	0	0	0	0	0	0	0	0	0	0	0
13	0	0	0	0	0	0	0	0	0	0	0	0	0	0	0	0	0
14	0	0	0	0	0	0	0	0	0	0	0	0	0	0	0	0	0
15	0	0	0	0	0	0	0	0	0	0	0	0	0	0	0	0	0
16	0	0	0	0	0	0	0	0	0	0	0	0	0	0	0	0	0
17	0	0	0	0	0	0	0	0	0	0	0	0	0	0	0	0	0
18	0	0	0	0	0	0	0	0	0	0	0	0	0	0	0	0	0
19	0	0	0	0	0	0	0	0	0	0	0	0	0	0	0	0	0
20	0	0	0	0	0	0	0	0	0	0	0	0	0	0	0	0	0
21	0	0	0	0	0	0	0	0	0	0	0	0	0	0	0	0	0
22	0	0	0	0	0	0	0	0	0	0	0	0	0	0	0	0	0
23	0	0	0	0	0	0	0	0	0	0	0	0	0	0	0	0	0

### Parameter description:

Port	The logical port for the settings contained in the same row.
Q1 – Qn	There are several QoS queues per port. Q0 is the lowest priority queue.
Rx/Tx	The number of received and transmitted packets per queue.
Auto refresh	The simple counts will be refreshed automatically on the UI screen.
Refresh	The simple counts will be refreshed manually when user use mouse to click on “Refresh” button.
Clear	The simple counts will be reset to zero when user use mouse to click on “Clear” button.

## 2.2.13 Port - SFP Information

### Function name:

SFP Information

### Function description:

The section describes that switch could display the SFP module detail information which you connect it to the switch. The information includes: Connector type, Fiber type, wavelength, baud rate and Vendor OUI etc.

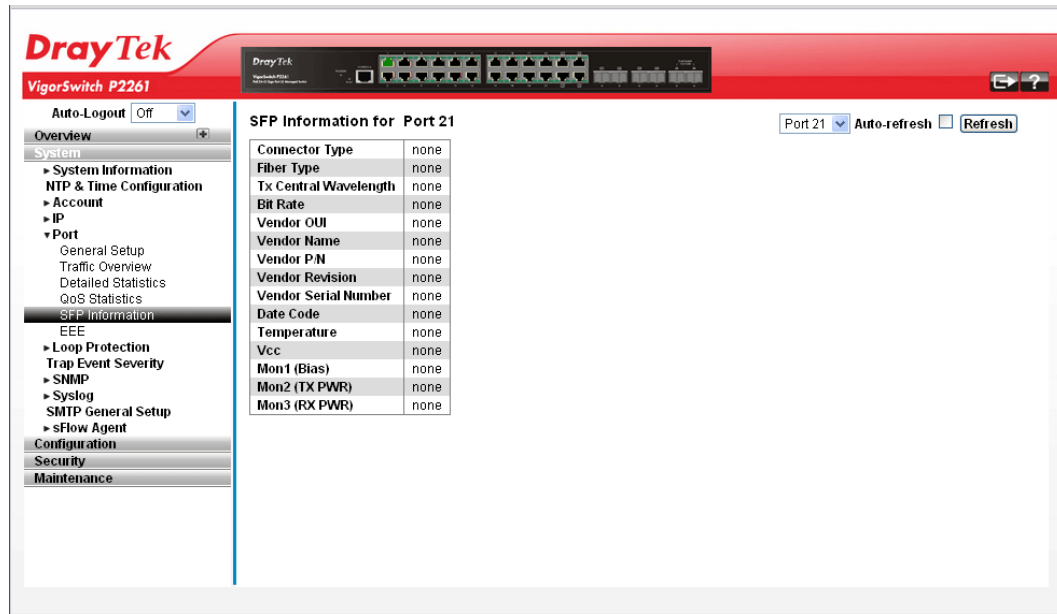

### Parameter description:

Connector Type	Display the connector type, for instance, UTP, SC, ST, LC and so on.
Fiber Type	Display the fiber mode, for instance, Multi-Mode, Single-Mode.
Tx Central Wavelength	Display the fiber optical transmitting central wavelength, for instance, 850nm, 1310nm, 1550nm and so on.
Bit Rate	Display the maximum baud rate of the fiber module supported, for instance, 10M, 100M, 1G and so on.
Vendor OUI	Display the Manufacturer's OUI code which is assigned by IEEE.
Vendor Name	Display the company name of the module manufacturer.
Vendor P/N	Display the product name of the naming by module manufacturer.
Vendor Revision	Display the module revision.
Vendor Serial Number	Show the serial number assigned by the manufacturer.
Date Code	Show the date this SFP module was made.
Temperature	Show the current temperature of SFP module.
Vcc	Show the working DC voltage of SFP module.

Mon1(Bias)	Show the Bias current of SFP module.
Mon2(TX PWR)	Show the transmit power of SFP module.
Mon3(RX PWR)	Show the receiver power of SFP module.

## 2.2.14 Port - EEE

EEE is a power saving option that reduces the power usage when there is very low traffic utilization (or no traffic). EEE works by powering down circuits when there is no traffic. When a port gets data to be transmitted all circuits are powered up. The time it takes to power up the circuits is named wakeup time. The default wakeup time is 17 us for 1Gbit links and 30 us for other link speeds. EEE devices must agree upon the value of the wakeup time in order to make sure that both the receiving and transmitting device has all circuits powered up when traffic is transmitted. The devices can exchange information about the devices wakeup time using the LLDP protocol.

For maximizing the power saving, the circuit isn't started at once transmit data are ready for a port, but is instead queued until 3000 bytes of data are ready to be transmitted. For not introducing a large delay in case that data less then 3000 bytes shall be transmitted, data are always transmitted after 48 us, giving a maximum latency of 48 us + the wakeup time.

If desired it is possible to minimize the latency for specific frames, by mapping the frames to a specific queue (done with QoS), and then mark the queue as an urgent queue. When an urgent queue gets data to be transmitted, the circuits will be powered up at once and the latency will be reduced to the wakeup time.

### Function name:

EEE

### Function description:

The section allows the user to inspect and configure the current EEE port settings.

The screenshot shows the DrayTek VigorSwitch P2261 web interface. The main content area is titled "EEE Configuration". It features a table for configuring EEE Urgent Queues across 19 ports. The table has columns for "Port", "EEE Enabled", and eight "EEE Urgent Queues" (numbered 1-8). Each cell in the table contains a checkbox.

Port	EEE Enabled	EEE Urgent Queues							
		1	2	3	4	5	6	7	8
*	<input type="checkbox"/>	<input type="checkbox"/>	<input type="checkbox"/>	<input type="checkbox"/>	<input type="checkbox"/>	<input type="checkbox"/>	<input type="checkbox"/>	<input type="checkbox"/>	<input type="checkbox"/>
1	<input type="checkbox"/>	<input type="checkbox"/>	<input type="checkbox"/>	<input type="checkbox"/>	<input type="checkbox"/>	<input type="checkbox"/>	<input type="checkbox"/>	<input type="checkbox"/>	<input type="checkbox"/>
2	<input type="checkbox"/>	<input type="checkbox"/>	<input type="checkbox"/>	<input type="checkbox"/>	<input type="checkbox"/>	<input type="checkbox"/>	<input type="checkbox"/>	<input type="checkbox"/>	<input type="checkbox"/>
3	<input type="checkbox"/>	<input type="checkbox"/>	<input type="checkbox"/>	<input type="checkbox"/>	<input type="checkbox"/>	<input type="checkbox"/>	<input type="checkbox"/>	<input type="checkbox"/>	<input type="checkbox"/>
4	<input type="checkbox"/>	<input type="checkbox"/>	<input type="checkbox"/>	<input type="checkbox"/>	<input type="checkbox"/>	<input type="checkbox"/>	<input type="checkbox"/>	<input type="checkbox"/>	<input type="checkbox"/>
5	<input type="checkbox"/>	<input type="checkbox"/>	<input type="checkbox"/>	<input type="checkbox"/>	<input type="checkbox"/>	<input type="checkbox"/>	<input type="checkbox"/>	<input type="checkbox"/>	<input type="checkbox"/>
6	<input type="checkbox"/>	<input type="checkbox"/>	<input type="checkbox"/>	<input type="checkbox"/>	<input type="checkbox"/>	<input type="checkbox"/>	<input type="checkbox"/>	<input type="checkbox"/>	<input type="checkbox"/>
7	<input type="checkbox"/>	<input type="checkbox"/>	<input type="checkbox"/>	<input type="checkbox"/>	<input type="checkbox"/>	<input type="checkbox"/>	<input type="checkbox"/>	<input type="checkbox"/>	<input type="checkbox"/>
8	<input type="checkbox"/>	<input type="checkbox"/>	<input type="checkbox"/>	<input type="checkbox"/>	<input type="checkbox"/>	<input type="checkbox"/>	<input type="checkbox"/>	<input type="checkbox"/>	<input type="checkbox"/>
9	<input type="checkbox"/>	<input type="checkbox"/>	<input type="checkbox"/>	<input type="checkbox"/>	<input type="checkbox"/>	<input type="checkbox"/>	<input type="checkbox"/>	<input type="checkbox"/>	<input type="checkbox"/>
10	<input type="checkbox"/>	<input type="checkbox"/>	<input type="checkbox"/>	<input type="checkbox"/>	<input type="checkbox"/>	<input type="checkbox"/>	<input type="checkbox"/>	<input type="checkbox"/>	<input type="checkbox"/>
11	<input type="checkbox"/>	<input type="checkbox"/>	<input type="checkbox"/>	<input type="checkbox"/>	<input type="checkbox"/>	<input type="checkbox"/>	<input type="checkbox"/>	<input type="checkbox"/>	<input type="checkbox"/>
12	<input type="checkbox"/>	<input type="checkbox"/>	<input type="checkbox"/>	<input type="checkbox"/>	<input type="checkbox"/>	<input type="checkbox"/>	<input type="checkbox"/>	<input type="checkbox"/>	<input type="checkbox"/>
13	<input type="checkbox"/>	<input type="checkbox"/>	<input type="checkbox"/>	<input type="checkbox"/>	<input type="checkbox"/>	<input type="checkbox"/>	<input type="checkbox"/>	<input type="checkbox"/>	<input type="checkbox"/>
14	<input type="checkbox"/>	<input type="checkbox"/>	<input type="checkbox"/>	<input type="checkbox"/>	<input type="checkbox"/>	<input type="checkbox"/>	<input type="checkbox"/>	<input type="checkbox"/>	<input type="checkbox"/>
15	<input type="checkbox"/>	<input type="checkbox"/>	<input type="checkbox"/>	<input type="checkbox"/>	<input type="checkbox"/>	<input type="checkbox"/>	<input type="checkbox"/>	<input type="checkbox"/>	<input type="checkbox"/>
16	<input type="checkbox"/>	<input type="checkbox"/>	<input type="checkbox"/>	<input type="checkbox"/>	<input type="checkbox"/>	<input type="checkbox"/>	<input type="checkbox"/>	<input type="checkbox"/>	<input type="checkbox"/>
17	<input type="checkbox"/>	<input type="checkbox"/>	<input type="checkbox"/>	<input type="checkbox"/>	<input type="checkbox"/>	<input type="checkbox"/>	<input type="checkbox"/>	<input type="checkbox"/>	<input type="checkbox"/>
18	<input type="checkbox"/>	<input type="checkbox"/>	<input type="checkbox"/>	<input type="checkbox"/>	<input type="checkbox"/>	<input type="checkbox"/>	<input type="checkbox"/>	<input type="checkbox"/>	<input type="checkbox"/>
19	<input type="checkbox"/>	<input type="checkbox"/>	<input type="checkbox"/>	<input type="checkbox"/>	<input type="checkbox"/>	<input type="checkbox"/>	<input type="checkbox"/>	<input type="checkbox"/>	<input type="checkbox"/>

### Parameter description:

Port	The switch port number of the logical EEE port.
EEE Enabled	Controls whether EEE is enabled for this switch port.

EEE Urgent Queues	Queues set will activate transmission of frames as soon as any data is available. Otherwise the queue will postpone the transmission until 3000 bytes are ready to be transmitted.
-------------------	--

After finished the above settings, click **Apply** to save the configuration.

## 2.2.15 Loop Protection – General Setup

The loop protection is used to detect the presence of traffic. When switch receives packet's (looping detection frame) MAC address the same as oneself from port, show Loop detection happens. The port will be locked when it received the looping detection frames. If you want to resume the locked port, please find out the looping path and take off the looping path, then select the resume the locked port and click on "Resume" to turn on the locked ports.

### Function name:

General Setup

### Function description:

Display whether switch opens Loop protection.

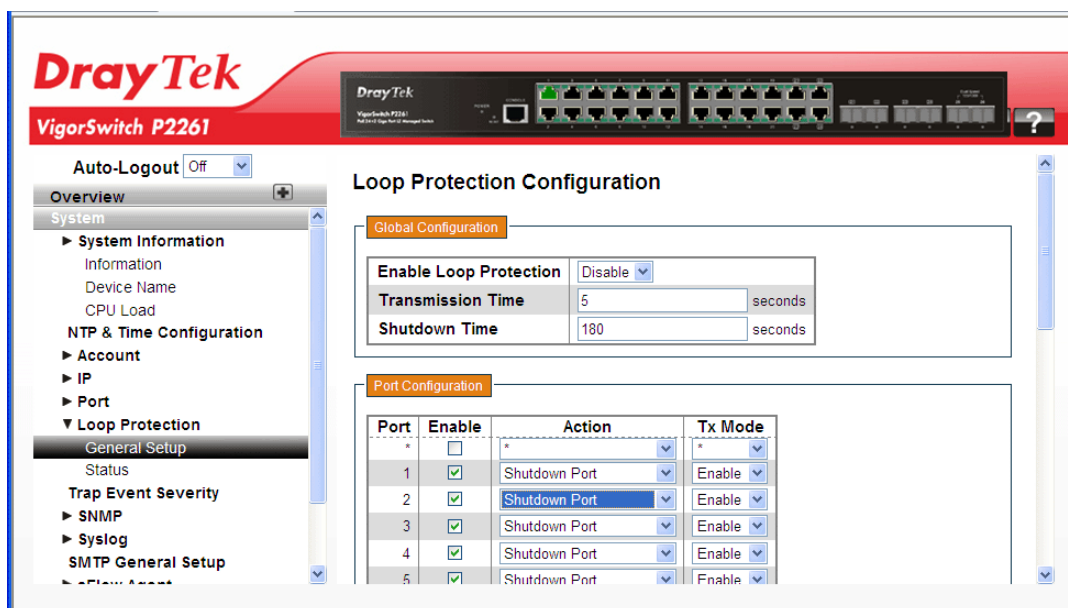

### Parameter description:

Global Configuration	
Enable Loop Protection	Choose Enable to activate this function. The default setting is Disable.
Transmission Time	The interval between each loop protection PDU sent on each port. Valid values are 1 to 10 seconds.
Shutdown Time	The period (in seconds) for which a port will be kept disabled in the event of a loop is detected (and the port action shuts down the port). Valid values are 0 to 604800 seconds (7 days). A value of zero will keep a port disabled (until next device restart).



Port Configuration	
Port	Display the port number. The number is 1 – 26.
Enable	When Port No is chosen, and enable port's Loop detection, the port can detect loop happens. When Port-No is chosen, enable port's Loop detection, and the port detects loop happen, port will be locked. If Loop did not happen, port maintains Unlocked.
Action	Configures the action performed when a loop is detected on a port. Valid values are Shutdown Port, Shutdown Port and Log or Log Only.
Tx Mode	Controls whether the port is actively generating loop protection PDU's, or whether it is just passively looking for looped PDU's.

After finished the above settings, click **Apply** to save the configuration.

## 2.2.16 Loop Protection – Status

**Function name:**

General Status

**Function description:**

Display the status for the switch which opens Loop protection.

**DrayTek VigorSwitch P2261**

Auto-Logout  Off

Overview

System

- System Information
  - Information
  - Device Name
  - CPU Load
- NTP & Time Configuration
- Account
- IP
- Port
- Loop Protection
  - General Setup
  - Status
- Trap Event Severity
- SNMP
- Syslog
- SMTP General Setup
- Flow Agent

**Loop Protection Status** Auto-refresh  Refresh

Port	Action	Transmit	Loops	Status	Loop	Time of Last Loop
1	Shutdown	Enabled	0	Up	-	-
2	Shutdown	Enabled	0	Down	-	-
3	Shutdown	Enabled	0	Down	-	-
4	Shutdown	Enabled	0	Down	-	-
5	Shutdown	Enabled	0	Down	-	-
6	Shutdown	Enabled	0	Down	-	-
7	Shutdown	Enabled	0	Down	-	-
8	Shutdown	Enabled	0	Down	-	-
9	Shutdown	Enabled	0	Down	-	-
10	Shutdown	Enabled	0	Down	-	-
11	Shutdown	Enabled	0	Down	-	-
12	Shutdown	Enabled	0	Down	-	-
13	Shutdown	Enabled	0	Down	-	-
14	Shutdown	Enabled	0	Down	-	-
15	Shutdown	Enabled	0	Down	-	-
16	Shutdown	Enabled	0	Down	-	-

**Parameter description:**

Port	Display the port number. The number is 1 – 26.
Action	Display the currently configured port action.
Transmit	Display the currently configured port transmit mode.
Loops	Display the number of loops detected on this port.
Status	Display the current loop protection status of the port.

Loop	Display Whether a loop is currently detected on the port.
Time of Last Loop	Display the time of the last loop event detected.
Auto refresh	The simple counts will be refreshed automatically on the UI screen.
Refresh	The simple counts will be refreshed manually when user use mouse to click on “Refresh” button.

## 2.2.17 Trap Event Severity

### Function name:

Trap Event Severity

### Function description:

The function is used to set a Alarm trap and get the Event log. The Trap Events Configuration function is used to enable the switch to send out the trap information while pre-defined trap events occurred.

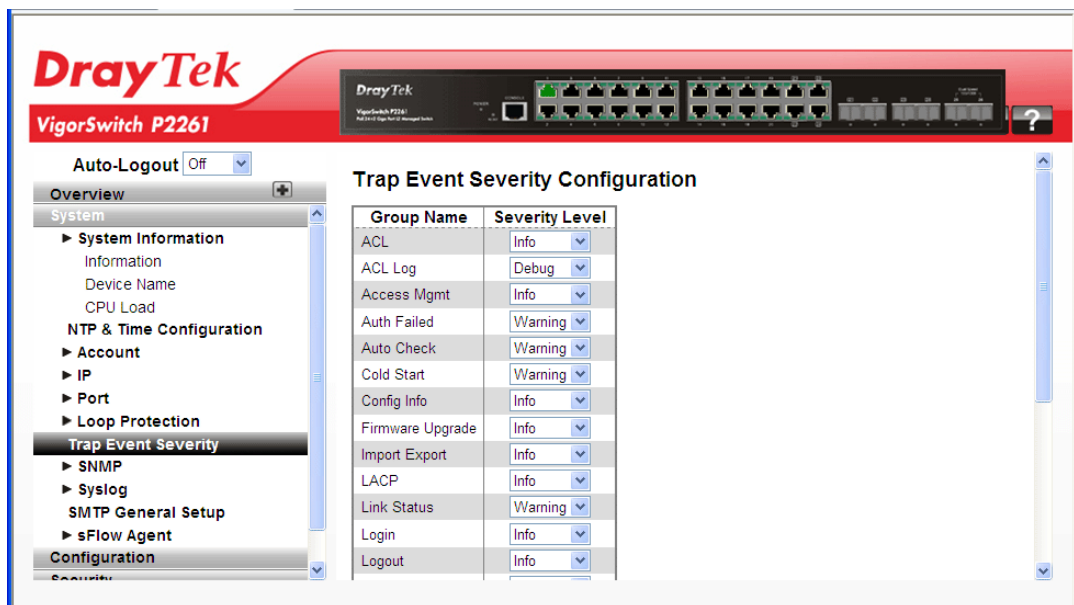

### Parameter description:

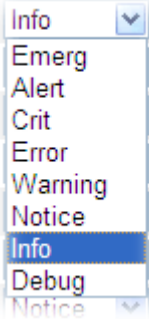
Group Name	The name identifies the severity group.
Severity Level	<p>Scroll to select a severity level on each group. The following level types are supported:</p>  <p>&lt;0&gt; Emergency: System is unusable.</p>

- <1> Alert: Action must be taken immediately.
- <2> Critical: Critical conditions.
- <3> Error: Error conditions.
- <4> Warning: Warning conditions.
- <5> Notice: Normal but significant conditions.
- <6> Information: Information messages.
- <7> Debug: Debug-level messages.

After finished the above settings, click **Apply** to save the configuration. Or, click **Reset** to cancel the settings just made.

## 2.2.18 SNMP - System

Any Network Management System (NMS) running the Simple Network Management Protocol (SNMP) can manage the Managed devices equipped with SNMP agent, provided that the Management Information Base (MIB) is installed correctly on the managed devices. The SNMP is a protocol that is used to govern the transfer of information between SNMP manager and agent and traverses the Object Identity (OID) of the management Information Base (MIB), described in the form of SMI syntax. SNMP agent is running on the switch to response the request issued by SNMP manager.

Basically, it is passive except issuing the trap information. The switch supports a switch to turn on or off the SNMP agent. If you set the field SNMP “Enable”, SNMP agent will be started up. All supported MIB OIDs, including RMON MIB, can be accessed via SNMP manager. If the field SNMP is set “Disable”, SNMP agent will be de-activated, the related Community Name, Trap Host IP Address, Trap and all MIB counters will be ignored.

### Function name:

System

### Function description:

This function is used to enable SNMP settings.

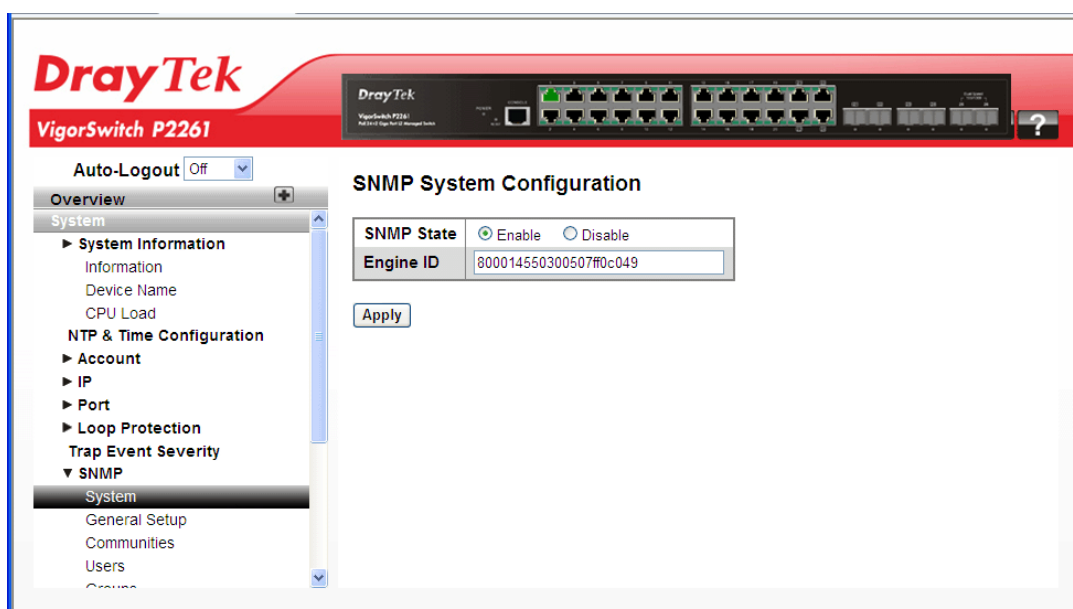

### Parameter Description:

SNMP State	The term SNMP here The term SNMP here is used for the activation or de-activation of SNMP.
------------	--

	Enable: Enable SNMP state operation. Disable: Disable SNMP state operation. Default: Enable.
Engine ID	SNMPv3 engine ID. syntax: 0-9,a-f,A-F, min 5 octet, max 32 octet, fifth octet can't input 00. IF change the Engine ID that will clear all original user.

After finished the above settings, click **Apply** to save the configuration.

## 2.2.19 SNMP – General Setup

### Function name:

General Setup

### Function description:

This function is used to configure general settings for SNMP. A SNMP manager must pass the authentication by identifying both community names, then it can access the MIB information of the target device. So, both parties must have the same community name.

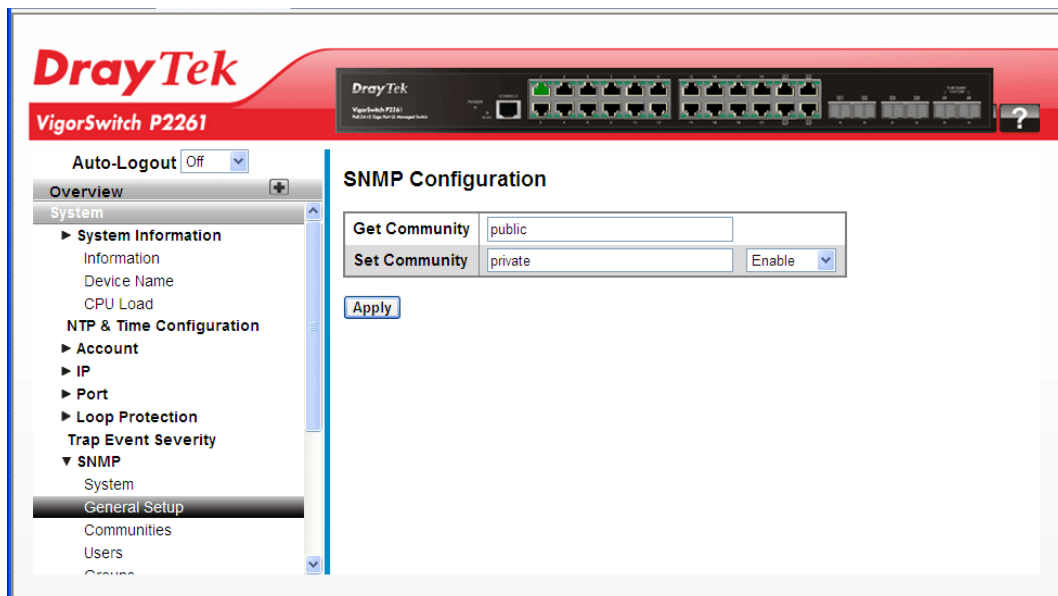

### Parameter Description:

Get Community	Indicate the community read access string to permit access to SNMP agent. The allowed string length is 0 to 255, and the allowed content is the ASCII characters from 33 to 126. The field is applicable only when SNMP version is SNMPv1 or SNMPv2c. If SNMP version is SNMPv3, the community string will be associated with SNMPv3 communities table. It provides more flexibility to configure security name than a SNMPv1 or SNMPv2c community string. In addition to community string, a particular range of source addresses can be used to restrict source subnet.
Set Community	Indicate the community write access string to permit access to SNMP agent. The allowed string length is 0 to 255, and the allowed content is the ASCII characters from 33 to 126. The field is applicable only when SNMP version is

	SNMPv1 or SNMPv2c.
Mode	Indicate the Set Community mode operation. Possible modes are: Enabled: Enable Set Community. Disabled: Disable Set Community.

After finished the above settings, click **Apply** to save the configuration. The settings will take effect.

## 2.2.20 SNMP – Communities

### Function name:

Communities

### Function description:

This function is used to configure SNMPv3 communities. The Community and User Name are unique. To create a new community account, please click the Add new community button, and enter the account information then click Apply.

Max Group Number: 4.

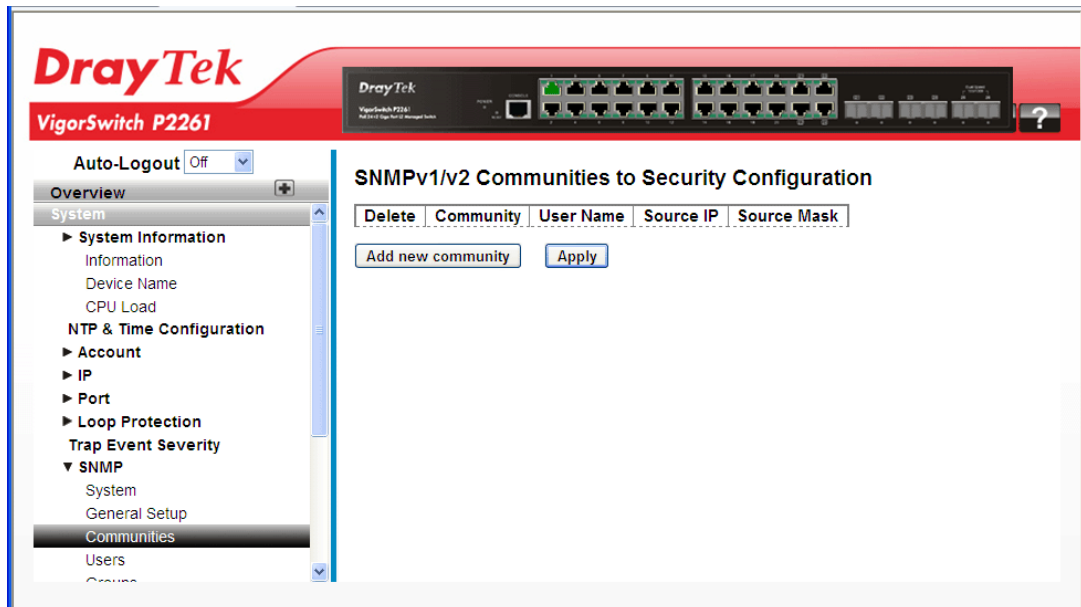

### Parameter Description:

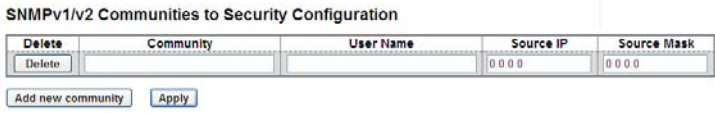
Delete	Click it to delete the selected community setting.
Community	Display the community access string.
User Name	Display a string identifying the user name that this entry should belong to.
Source IP	Display the SNMP access source IP address.
Source Mask	Display the source address mask.
Add new community	Click it to add a new community.  

	<p>Community – Indicates the community access string to permit access to SNMPv3 agent. The allowed string length is 1 to 32, and the allowed content is ASCII characters from 33 to 126. The community string will be treated as security name and map a SNMPv1 or SNMPv2c community string.</p> <p>User Name – The length of “User Name” string is restricted to 1-32, and the allowed content is ASCII characters from 33 to 126.</p> <p>Source IP – Indicates the SNMP access source address. A particular range of source addresses can be used to restrict source subnet when combined with source mask.</p> <p>Source Mask - Indicates the SNMP access source address mask.</p>
--	---

After finished the above settings, click **Apply** to save the configuration. The settings will take effect.

## 2.2.21 SNMP – Users

### Function name:

Users

### Function description:

This function is used to configure SNMPv3 user. The Entry index key is User Name. To create a new User Name account, please click the Add new user button, and enter the user information then check Apply.

Max Group Number: 10.

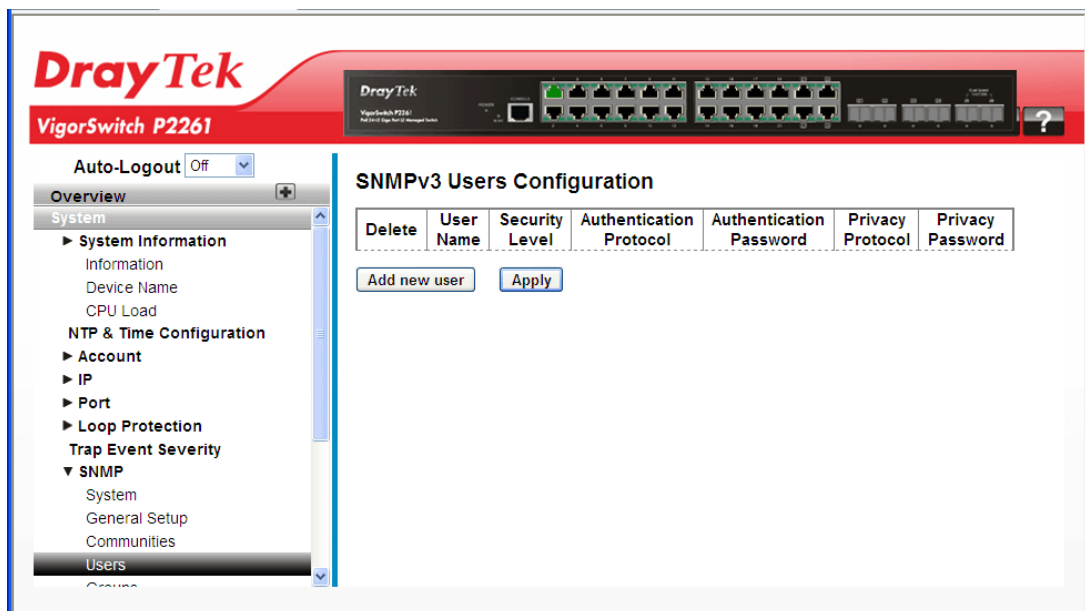

### Parameter Description:

Delete	Click it to delete the selected user setting.
User Name	A string identifying the user name that this entry should belong to. The allowed string length is 1 to 32, and the allowed content is ASCII characters from 33 to 126.

Security Level	<p>Indicates the security model that this entry should belong to. Possible security models are:</p> <p>NoAuth, NoPriv: No authentication and no privacy.</p> <p>Auth, NoPriv: Authentication and no privacy.</p> <p>Auth, Priv: Authentication and privacy.</p> <p>The value of security level cannot be modified if entry already exists. That means it must first be ensured that the value is set correctly.</p>														
Authentication Protocol	<p>Indicates the authentication protocol that this entry should belong to. Possible authentication protocols are:</p> <p>None: No authentication protocol.</p> <p>MD5: An optional flag to indicate that this user uses MD5 authentication protocol.</p> <p>SHA: An optional flag to indicate that this user uses SHA authentication protocol.</p> <p>The value of security level cannot be modified if entry already exists. That means must first ensure that the value is set correctly.</p>														
Authentication Password	<p>A string identifying the authentication password phrase. For MD5 authentication protocol, the allowed string length is 8 to 32. For SHA authentication protocol, the allowed string length is 8 to 40. The allowed content is ASCII characters from 33 to 126.</p>														
Privacy Protocol	<p>Indicates the privacy protocol that this entry should belong to. Possible privacy protocols are:</p> <p>None: No privacy protocol.</p> <p>DES: An optional flag to indicate that this user uses DES authentication protocol.</p>														
Privacy Password	<p>A string identifying the privacy password phrase. The allowed string length is 8 to 32, and the allowed content is ASCII characters from 33 to 126.</p>														
Add new user	<p>Click it to add a new user.</p> <p><b>SNMPv3 Users Configuration</b></p> <table border="1"> <thead> <tr> <th>Delete</th> <th>User Name</th> <th>Security Level</th> <th>Authentication Protocol</th> <th>Authentication Password</th> <th>Privacy Protocol</th> <th>Privacy Password</th> </tr> </thead> <tbody> <tr> <td>Delete</td> <td><input type="text"/></td> <td>Auth, Priv</td> <td>MD5</td> <td><input type="text"/></td> <td>DES</td> <td><input type="text"/></td> </tr> </tbody> </table> <p><input type="button" value="Add new user"/> <input type="button" value="Apply"/></p>	Delete	User Name	Security Level	Authentication Protocol	Authentication Password	Privacy Protocol	Privacy Password	Delete	<input type="text"/>	Auth, Priv	MD5	<input type="text"/>	DES	<input type="text"/>
Delete	User Name	Security Level	Authentication Protocol	Authentication Password	Privacy Protocol	Privacy Password									
Delete	<input type="text"/>	Auth, Priv	MD5	<input type="text"/>	DES	<input type="text"/>									

After finished the above settings, click **Apply** to save the configuration. The settings will take effect.

## 2.2.22 SNMP – Groups

**Function name:**

Groups

**Function description:**

This function is used to configure SNMPv3 group. To create a new group account, please click the Add new group button, and enter the group information then click Apply.

Max Group Number: v1: 2, v2: 2, v3:10.

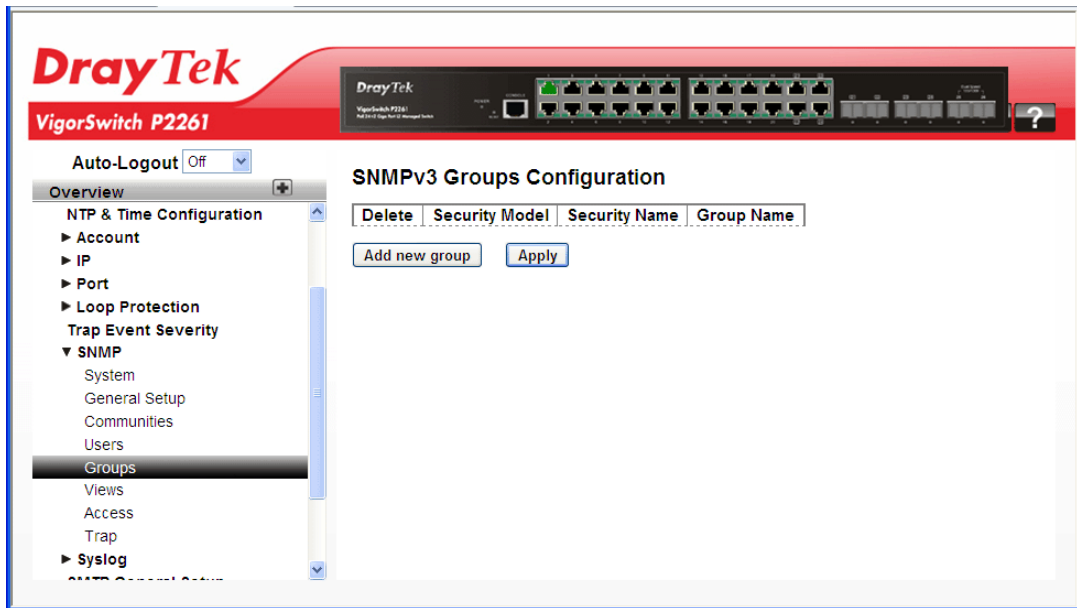

**Parameter Description:**

Delete	Click it to delete the selected user setting.								
Security Model	Indicates the security model that this entry should belong to. Possible security models are: v1: Reserved for SNMPv1. v2c: Reserved for SNMPv2c. usm: User-based Security Model (USM).								
Security Name	A string identifying the security name that this entry should belong to. The allowed string length is 1 to 32, and the allowed content is ASCII characters from 33 to 126.								
Group Name	A string identifying the group name that this entry should belong to. The allowed string length is 1 to 32, and the allowed content is ASCII characters from 33 to 126.								
Add new group	Click it to add a new user.  <div style="border: 1px solid black; padding: 5px;"> <p><b>SNMPv3 Groups Configuration</b></p> <table border="1" style="width: 100%; border-collapse: collapse;"> <thead> <tr> <th style="width: 10%;">Delete</th> <th style="width: 15%;">Security Model</th> <th style="width: 45%;">Security Name</th> <th style="width: 30%;">Group Name</th> </tr> </thead> <tbody> <tr> <td style="text-align: center;">Delete</td> <td style="text-align: center;">v1</td> <td style="text-align: center;">Test-1</td> <td></td> </tr> </tbody> </table> <p style="text-align: center;"> <input type="button" value="Add new group"/> <input type="button" value="Apply"/> </p> </div>	Delete	Security Model	Security Name	Group Name	Delete	v1	Test-1	
Delete	Security Model	Security Name	Group Name						
Delete	v1	Test-1							

After finished the above settings, click **Apply** to save the configuration. The settings will take effect.



## 2.2.23 SNMP – Views

**Function name:**

Views

**Function description:**

This function is used to configure SNMPv3 view. The Entry index key includes OID Subtree and View Name. To create a new view account, please click the Add new view button, and enter the view information then click Apply.

Max Group Number: 28.

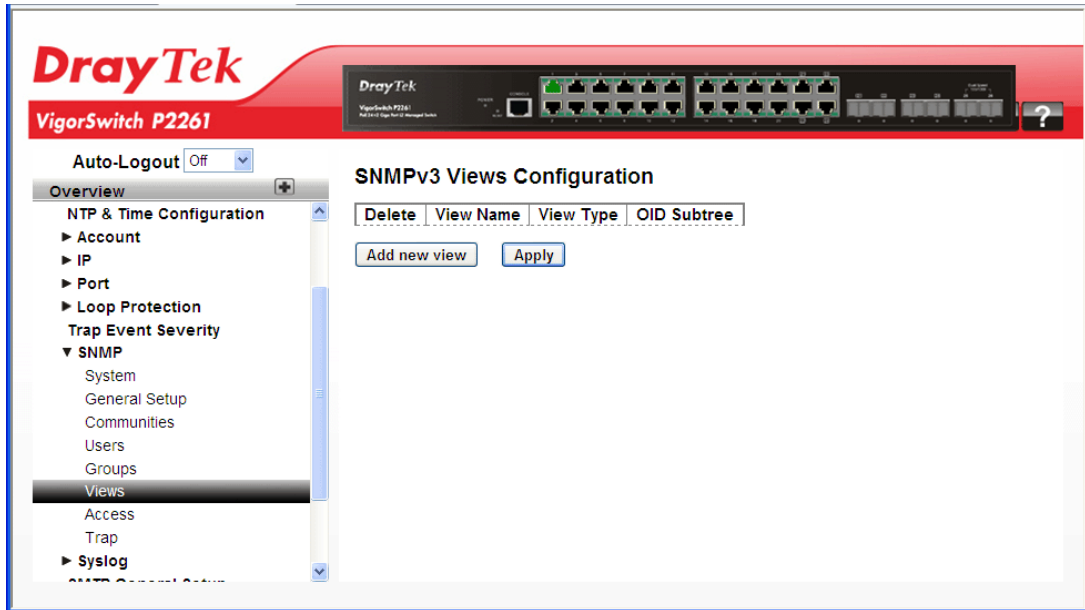

**Parameter Description:**

Delete	Click it to delete the selected user setting.
View Name	A string identifying the view name that this entry should belong to. The allowed string length is 1 to 32, and the allowed content is ASCII characters from 33 to 126.
View Type	Indicates the view type that this entry should belong to. Possible view types are: included: An optional flag to indicate that this view subtree should be included. excluded: An optional flag to indicate that this view subtree should be excluded. In general, if a view entry's view type is 'excluded', there should be another view entry existing with view type as 'included' and it's OID subtree should overstep the 'excluded' view entry.
OID Subtree	The OID defining the root of the subtree to add to the named view. The allowed OID length is 1 to 128. The allowed string content is digital number or asterisk (*).
Add new group	Click it to add a new user.

SNMPv3 Views Configuration			
Delete	View Name	View Type	OID Subtree
Delete	<input type="text"/>	included	<input type="text"/>
Add new view		Apply	

After finished the above settings, click **Apply** to save the configuration. The settings will take effect.

## 2.2.24 SNMP – Access

### Function name:

Access

### Function description:

This function is used to configure SNMPv3 accesses. The Entry index key are Group Name, Security Model and Security level. To create a new access account, please click the Add new access button, and enter the access information then click Apply.

Max Group Number: 14

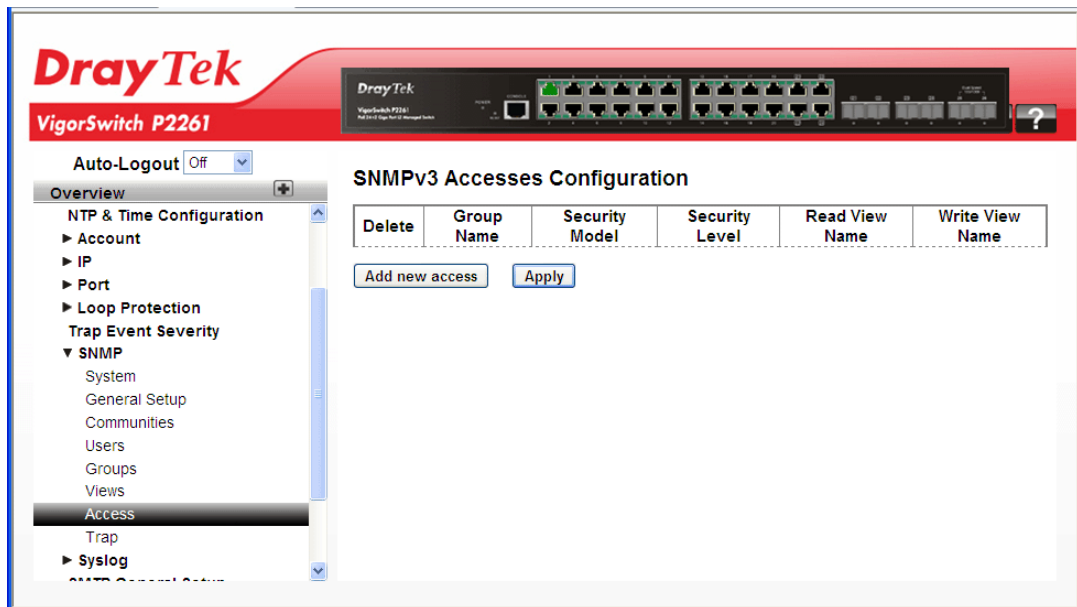

### Parameter Description:

Delete	Click it to delete the selected user setting.
Group Name	A string identifying the group name that this entry should belong to. The allowed string length is 1 to 32, and the allowed content is ASCII characters from 33 to 126.
Security Model	Indicates the security model that this entry should belong to. Possible security models are: any: Any security model accepted(v1 v2c usm). v1: Reserved for SNMPv1. v2c: Reserved for SNMPv2c. usm: User-based Security Model (USM).

Security Level	Indicates the security model that this entry should belong to. Possible security models are: NoAuth, NoPriv: No authentication and no privacy. Auth, NoPriv: Authentication and no privacy. Auth, Priv: Authentication and privacy.												
Read View Name	The name of the MIB view defines the MIB objects for which this request may request the current values. The allowed string length is 1 to 32, and the allowed content is ASCII characters from 33 to 126.												
Write View Name	The name of the MIB view defines the MIB objects for which this request may potentially set new values. The allowed string length is 1 to 32, and the allowed content is ASCII characters from 33 to 126.												
Add new access	Click it to add a new profile. <b>SNMPv3 Accesses Configuration</b> <table border="1"> <thead> <tr> <th>Delete</th> <th>Group Name</th> <th>Security Model</th> <th>Security Level</th> <th>Read View Name</th> <th>Write View Name</th> </tr> </thead> <tbody> <tr> <td>Delete</td> <td>First_Group</td> <td>any</td> <td>NoAuth, NoPriv</td> <td>None</td> <td>None</td> </tr> </tbody> </table> <input type="button" value="Add new access"/> <input type="button" value="Apply"/>	Delete	Group Name	Security Model	Security Level	Read View Name	Write View Name	Delete	First_Group	any	NoAuth, NoPriv	None	None
Delete	Group Name	Security Model	Security Level	Read View Name	Write View Name								
Delete	First_Group	any	NoAuth, NoPriv	None	None								

After finished the above settings, click **Apply** to save the configuration. The settings will take effect.

## 2.2.25 SNMP – Trap

**Function name:**

Trap

**Function description:**

This function is used to configure SNMP trap. To create a new trap account, please click the No number link, and enter the trap information then click Apply.

Max Group Number : 6.

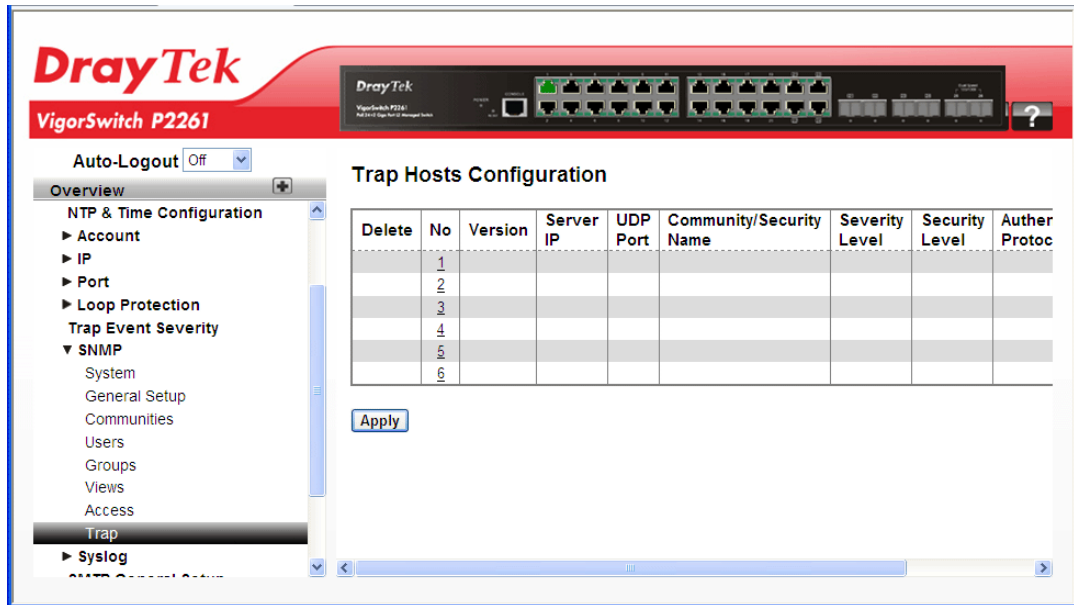

**Parameters description:**

Delete	Click to delete the entry.
No	Number link for Trap Host configuration.
Version	Display the version of the trap host.
Server IP	Display the SNMP Host IP address.
UDP Port	Display the port number for UDP.
Community /Security Name	Display the name of community / security.
Severity Level	Display the level for severity.
Security Level	Display the level for security.
Authentication Protocol	Display the protocol configured for authentication.
Privacy Protocol	Display the protocol configured for privacy.

Click the number link to access into the configuration page for each trap host.

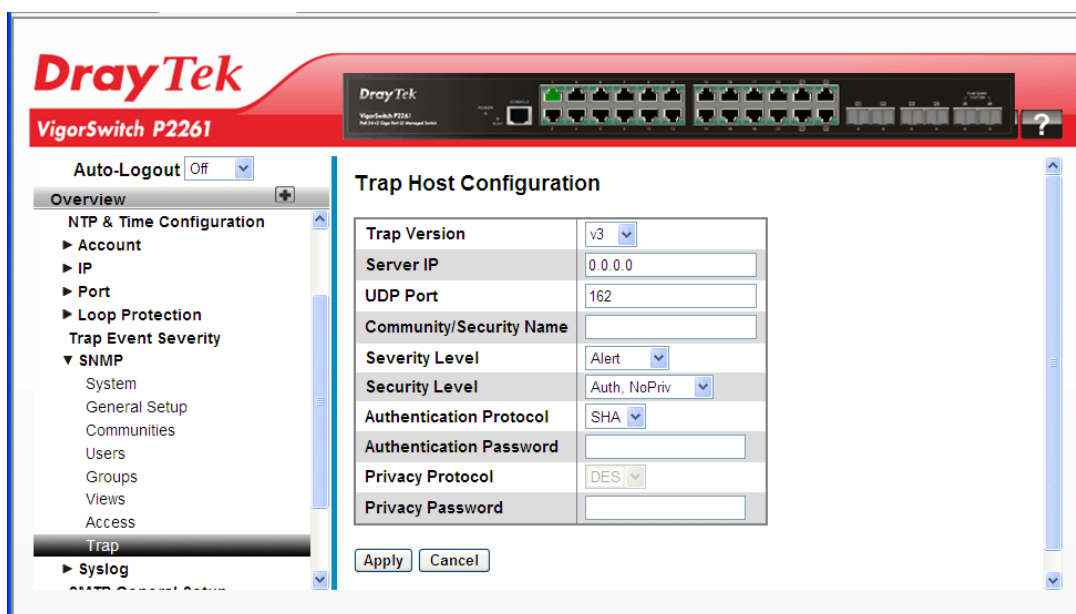

### Parameters description:

Trap Version	You may choose v1, v2c or v3 trap.
Server IP	Type the SNMP Host IP address.
UDP Port	Type the port number. Default: 162
Community / Security Name	The length of "Community / Security Name" string is restricted to 1-32.
Severity Level	Indicates what kind of message will send to Security Level. Possible modes are: Info: Send information, warnings and errors. Warning: Send warnings and errors. Error: Send errors.
Security Level	There are three kinds of choices. NoAuth, NoPriv: No authentication and no privacy. Auth, NoPriv: Authentication and no privacy. Auth, Priv: Authentication and privacy.
Authentication Protocol	You can choose MD5 or SHA for authentication.
Authentication Password	The length of 'MD5 Authentication Password' is restricted to 8 – 32. The length of 'SHA Authentication Password' is restricted to 8 – 40.
Privacy Protocol	You can set DES encryption for User Name.
Privacy Password	The length of ' Privacy Password ' is restricted to 8 – 32.

After finished the above settings, click **Apply** to save the configuration. The settings will take effect.

## 2.2.26 System Log – General Setup

### Function name:

System Log – General Setup

### Function description:

The Syslog is a standard for logging program messages. It allows separation of the software that generates messages from the system that stores them and the software that reports and analyzes them. It can be used as well a generalized informational, analysis and debugging messages. It is supported by a wide variety of devices and receivers across multiple platforms.

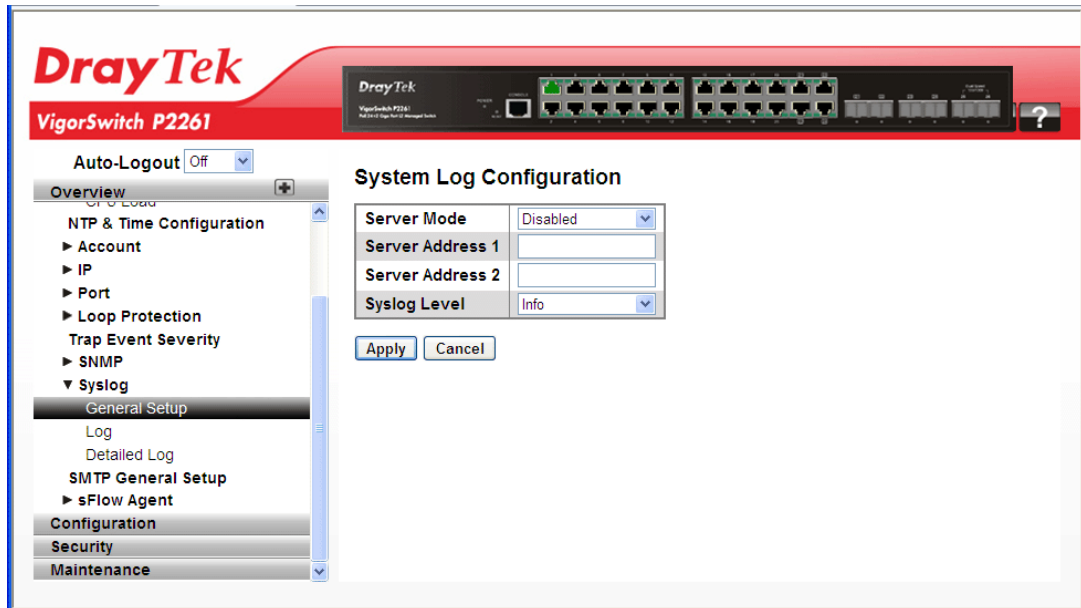

### Parameters description:

Server Mode	Indicates the server mode operation. When the mode operation is enabled, the syslog message will send out to syslog server. The syslog protocol is based on UDP communication and received on UDP port 514 and the syslog server will not send acknowledgments back sender since UDP is a connectionless protocol and it does not provide acknowledgments. The syslog packet will always send out even if the syslog server does not exist. Possible modes are: Enabled: Enable server mode operation. Disabled: Disable server mode operation.
Server Address	Indicates the IPv4 host address of syslog server. If the switch provide DNS feature, it also can be a host name.
Syslog Level	Indicates what kind of message will send to syslog server. Possible modes are: Emerg: Send Emerg Alert: Send Emerg, Alert Crit: Send Emerg, Alert, Crit Error: Send Emerg, Alert, Crit, Error Warning: Send warnings

	Notice: Send Emerg, Alert, Crit, Error, Warning, Notice
	Info: Send Emerg, Alert, Crit, Error, Warning, Notice, Info
	Debug: Send everything, i.e. all

After finished the above settings, click **Apply** to save the configuration. The settings will take effect.

## 2.2.27 System Log – Log

**Function name:**

System Log – Log

**Function description:**

It describes that display the system log information of the switch.

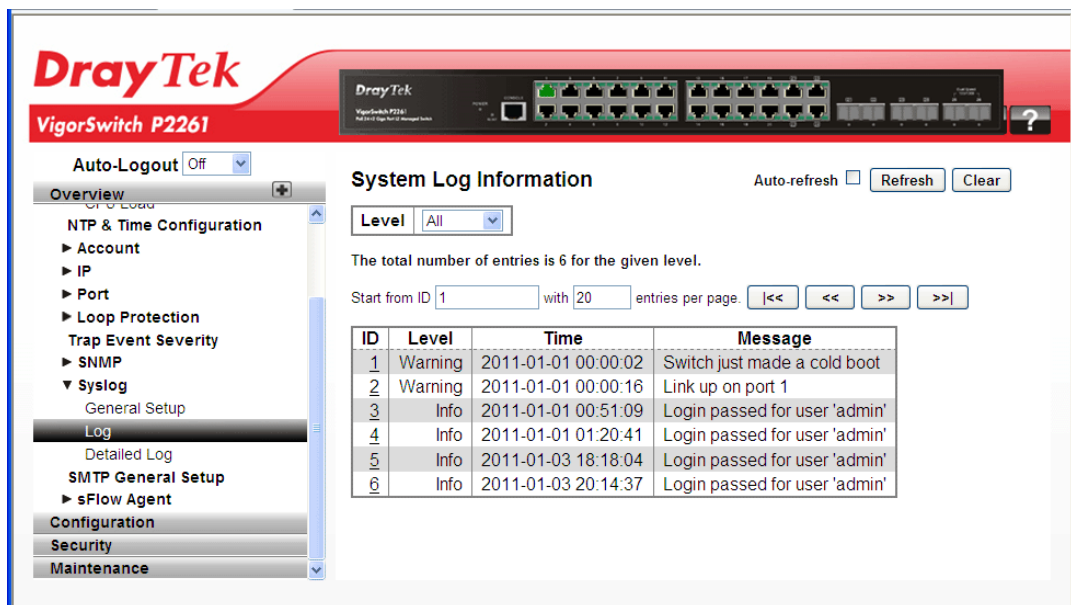

**Parameters description:**

ID	ID ( $\geq 1$ ) of the system log entry.
Level	Level of the system log entry. The following level types are supported: Info: Information level of the system log. Warning: Warning level of the system log. Error: Error level of the system log. All: All levels.
Time	The time of the system log entry.
Message	The message of the system log entry.
Auto refresh	The simple counts will be refreshed automatically on the UI screen.
Refresh	The simple counts will be refreshed manually when user use mouse to click on “Refresh” button.
Clear	The simple counts will be reset to zero when user use mouse to click on “Clear” button.

## 2.2.28 System Log – Detailed Log

**Function name:**

System Log – Detailed Log

**Function description:**

It describes that display the detailed log information of the switch

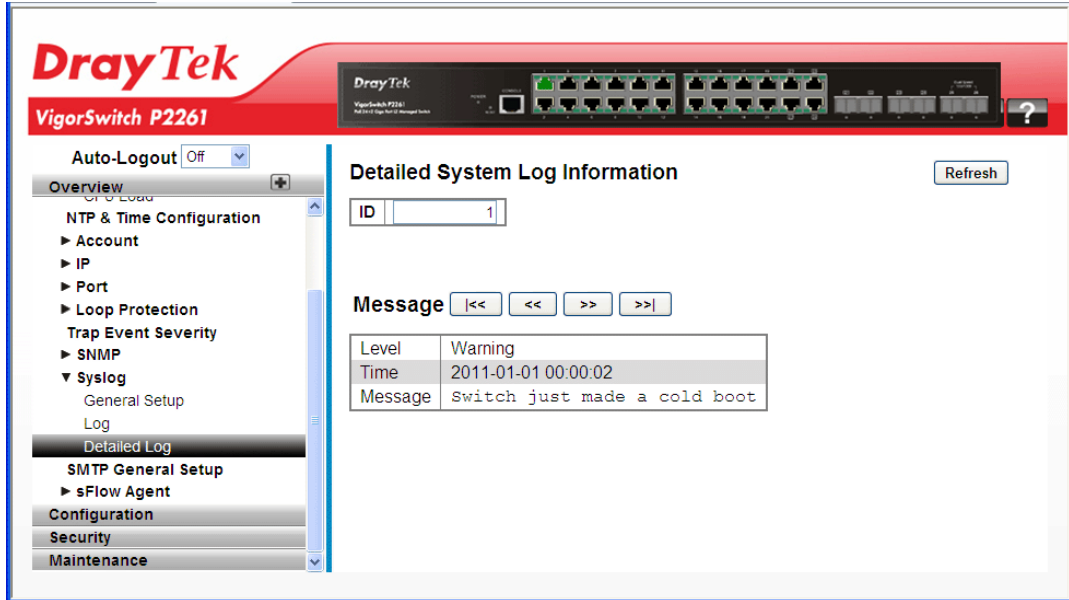

**Parameters description:**

ID	ID (>= 1) of the system log entry.
Message	The detailed message of the system log entry.
Refresh	The simple counts will be refreshed manually when user use mouse to click on “Refresh” button.



## 2.2.29 SMTP General Setup

**Function name:**

SMTP General Setup

**Function description:**

The function is used to set an Alarm trap when the switch alarm then you could set the SMTP server to send you the alarm mail.

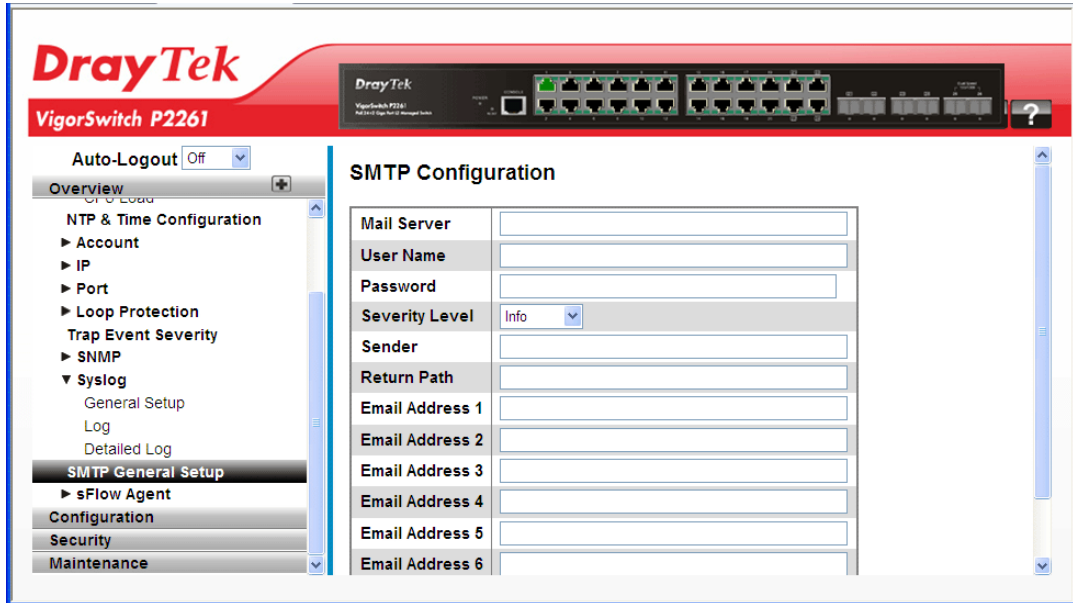

**Parameters description:**

Mail Server	Specify the IP Address of the server transferring your email.
Username	Specify the username on the mail server.
Password	Specify the password on the mail server.
Sender	Set the mail sender name.
Return-Path	To set the mail return-path as sender mail address.
Email Address 1-6	Email address that would like to receive the alarm message.

After finished the above settings, click **Apply** to save the configuration. The settings will take effect.

## 2.2.30 sFlow Agent - Collector

**Function name:**

sFlow Agent - Collector

**Function description:**

The sFlow Collector configuration for the switch can be monitored and modified here. Up to 1 Collector is supported. This page allows for configuring sFlow collector IP type, sFlow collector IP Address, Port Number, for each sFlow Collector.

The "Current " field displays the currently configured sFlow Collector. The "Configured" field displays the new Collector Configuration.

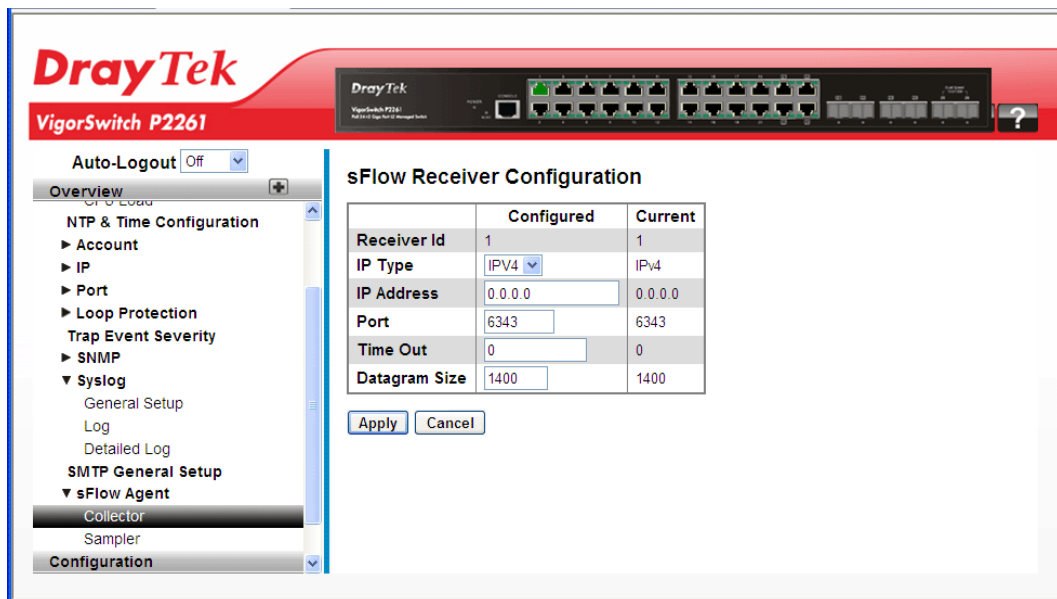

**Parameters description:**

Received Id	The "Receiver ID" input fields allow the user to select the receiver ID. Indicate the ID of this particular sFlow Receiver. Currently one ID is supported as one collector is supported.
IP Type	A drop down list to select the type of IP of Collector is displayed. By default, IPv4 is the type of Collector IP type. You could use IPv4 or IPv6.
IP Address	The address of a reachable IP is to be entered into the text box. This IP is used to monitor the sFlow samples sent by sFlow Agent (our switch). By default, The IP is set to 0.0.0.0, and a new entry has to be added to it.
Port	A port to listen to the sFlow Agent has to be configured for the Collector. The value of the port number has to be typed into the text box. The value accepted is within the range of 1-65535. But an appropriate port number not used by other protocols need to

	be configured. By default, the port's number is 6343.
Time Out	It is the duration during which the collector receives samples. Once it is expired the sampler stops sending the samples. It is through the management the value is set before it expires. The value accepted is within the range of 0-2147483647. By default it is set to 0.
Datagram Size	It is the maximum UDP datagram size to send out the sFlow samples to the receiver. The value accepted is within the range of 200-1500 bytes. The default is 1400 bytes.

After finished the above settings, click **Apply** to save the configuration. The settings will take effect.

## 2.2.31 sFlow Agent - Sampler

### Function name:

sFlow Agent - Sampler

### Function description:

The function is used to display the sFlow sampler what you set or you can edit it for your requirement. That will help user based on a defined sampling rate, an average of 1 out of N packets/operations is randomly sampled. This type of sampling does not provide a 100% accurate result, but it does provide a result with quantifiable accuracy.

The screenshot shows the DrayTek VigorSwitch P2261 web interface. The main content area is titled "sFlow Sampler Configuration" and contains a table with the following data:

sFlow Ports	sFlow Instance	Flow Sampling			Counter Sampling Polling Interval
		Sampler Type	Sampling Rate	Max Hdr Size	
1	1	None	0	128	0
2	1	None	0	128	0
3	1	None	0	128	0
4	1	None	0	128	0
5	1	None	0	128	0
6	1	None	0	128	0
7	1	None	0	128	0
8	1	None	0	128	0
9	1	None	0	128	0
10	1	None	0	128	0
11	1	None	0	128	0
12	1	None	0	128	0

### Parameters description:

sFlow Ports	Display the port numbers on which sFlow is configured.
sFlow Instance	Display the configured sFlow instance for the port number.
Flow Sampling	Packet flow sampling refers to arbitrarily choosing some packets out of a specified number, reading the first "Max Hdr Size" bytes and exporting the sampled datagram for analysis. The attributes associated with the flow sampling are: sampler type, sampling rate. Sampler Type - Configured sampler type on the port and could be any of the types: None, Rx, Tx or All. You can

	<p>scroll to choice one for your sampler type. By default, The value is “None”.</p> <p>Sampling Rate –Configured sampling rate on the ports.</p> <p>Max Hdr Size – Configured size of the header of the sampled frame.</p>
Counter Sampling	<p>Counter sampling performs periodic, time-based sampling or polling of counters associated with an interface enabled for sFlow. Attribute associated with counter sampling is polling interval.</p> <p>Polling Interval - Configured polling interval for the counter sampling.</p>

To edit the configuration for each sFlow Ports, click the button  to open the following page.

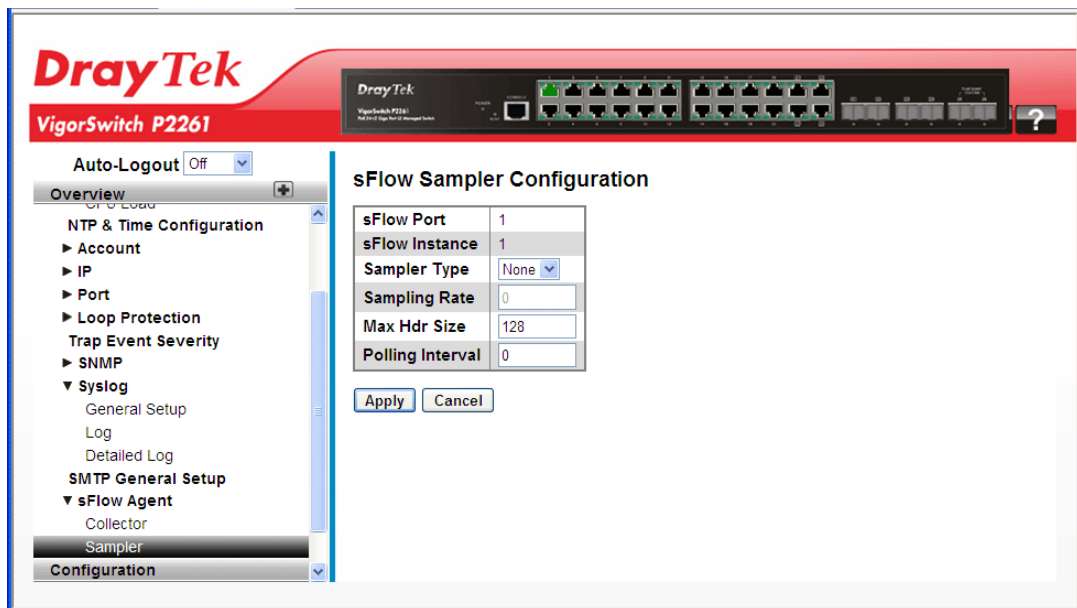

**Parameters description:**

sFlow Ports	This is the port number on which sFlow can be configured.
sFlow Instance	Multiple instances of sFlow can be supported on the port. Currently we support one sFlow instance on each port due to hardware limitation.
Sampler Type	Sampler type on the port can be one of the following types: None, RX, TX, ALL. If type is "none" then the sampling rate is 0 and no other value is accepted. The default value is "none".
Sampling Rate	<p>Determines the rate at which samples must be taken on the ports. If sampling rate is configured as 'N', 1/N frames is sampled.</p> <p>The sampling rate ranges from 0 to 4095.</p> <p>Default value is "0" meaning sampling is disabled on the port.</p> <p>If receiver time_out is 0sec, this sFlow configuration is disabled operationally.</p>

	To make it operational the receiver time_out has to remain alive. When operational, the sample rate 'N' is rounded off to the nearest possible value.
Max Hdr Size	Configures the size of the header of the sampled frame to be copied to the Queue for further processing. The Max header size ranges from 14 to 200 bytes. Default is 128 bytes.
Polling Interval	Configures the polling interval for the counter sampling. It decides at what regular intervals the counter should be polled for statistics. The accepted value for Counter Polling Interval ranges from 0 to 3600 seconds. Default is 0 seconds which means polling is disabled.

After finished the above settings, click **Apply** to save the configuration. The settings will take effect.

## 2.3 Configuration

### 2.3.1 Aggregation – Static Trunk

The Aggregation Configuration is used to configure the settings of Link Aggregation. You can bundle more than one port with the same speed, full duplex and the same MAC to be a single logical port, thus the logical port aggregates the bandwidth of these ports. This means you can apply your current Ethernet equipments to build the bandwidth aggregation.

**Function name:**

Aggregation – Static Trunk

**Function description:**

Ports using Static Trunk as their trunk method can choose their unique Static GroupID to form a logic “trunked port”. The benefit of using Static Trunk method is that a port can immediately become a member of a trunk group without any handshaking with its peer port. This is also a disadvantage because the peer ports of your static trunk group may not know that they should be aggregate together to form a “logic trunked port”. Using Static Trunk on both end of a link is strongly recommended. Please also note that low speed links will stay in “not ready” state when using static trunk to aggregate with high speed links.

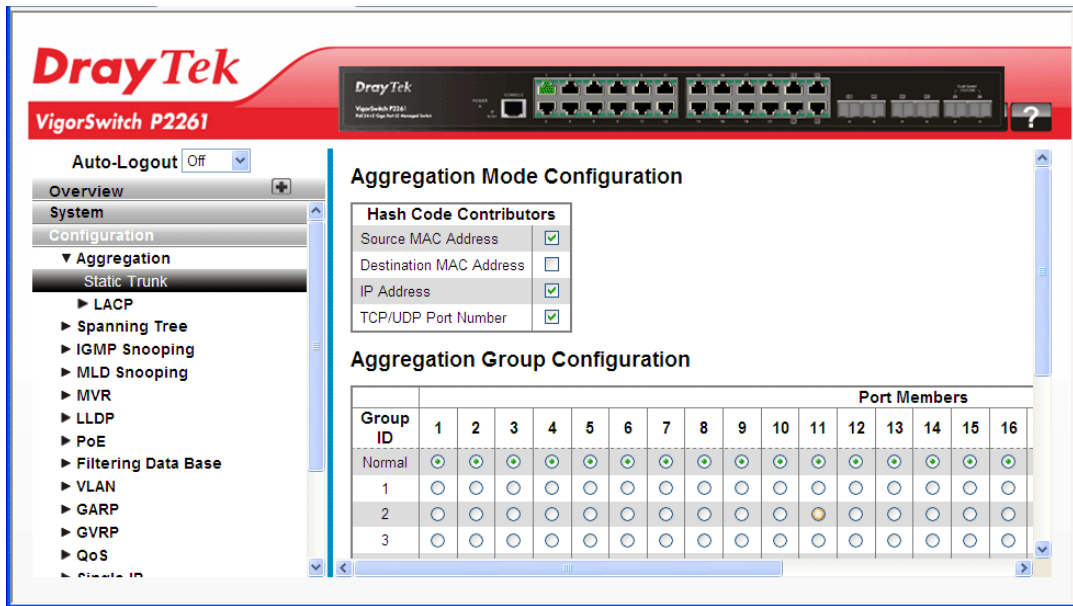

### Parameters description:

<p>Hash Code Contributors</p>	<p><i>Source MAC Address</i> - The Source MAC address can be used to calculate the destination port for the frame. Check to enable the use of the Source MAC address, or uncheck to disable. By default, Source MAC Address is enabled.</p> <p><i>Destination MAC Address</i> - The Destination MAC Address can be used to calculate the destination port for the frame. Check to enable the use of the Destination MAC Address, or uncheck to disable. By default, Destination MAC Address is disabled.</p> <p><i>IP Address</i> - The IP address can be used to calculate the destination port for the frame. Check to enable the use of the IP Address, or uncheck to disable. By default, IP Address is enabled.</p> <p><i>TCP/UDP Port Number</i> - The TCP/UDP port number can be used to calculate the destination port for the frame. Check to enable the use of the TCP/UDP Port Number, or uncheck to disable. By default, TCP/UDP Port Number is enabled.</p>
<p>Aggregation Group Configuration</p>	<p><i>Group ID</i> - Indicates the group ID for the settings contained in the same row. Group ID "Normal" indicates there is no aggregation. Only one group ID is valid per port.</p> <p><i>Port Members</i> - Each switch port is listed for each group ID. Select a radio button to include a port in an aggregation, or clear the radio button to remove the port from the aggregation. By default, no ports belong to any aggregation group. Only full duplex ports can join an aggregation and ports must be in the same speed in each group.</p>

After finished the above settings, click **Apply** to save the configuration. The settings will take effect.

## 2.3.2 Aggregation – LACP – General Setup

Ports using Link Aggregation Control Protocol (according to IEEE 802.3ad specification) as their trunking method can choose their unique LACP GroupID to form a logic “trunked port”. The benefit of using LACP is that a port makes an agreement with its peer port before it becomes a ready member of a “trunk group” (also called aggregator). LACP is safer than the other trunking method - static trunk.

### Function name:

Aggregation – LACP – General Setup

### Function description:

The function allows the user to inspect the current LACP port configurations, and possibly change them as well. An LACP trunk group with more than one ready member-port is a “real trunked” group. An LACP trunk group with only one or less than one ready member-port is not a “real trunked” group.

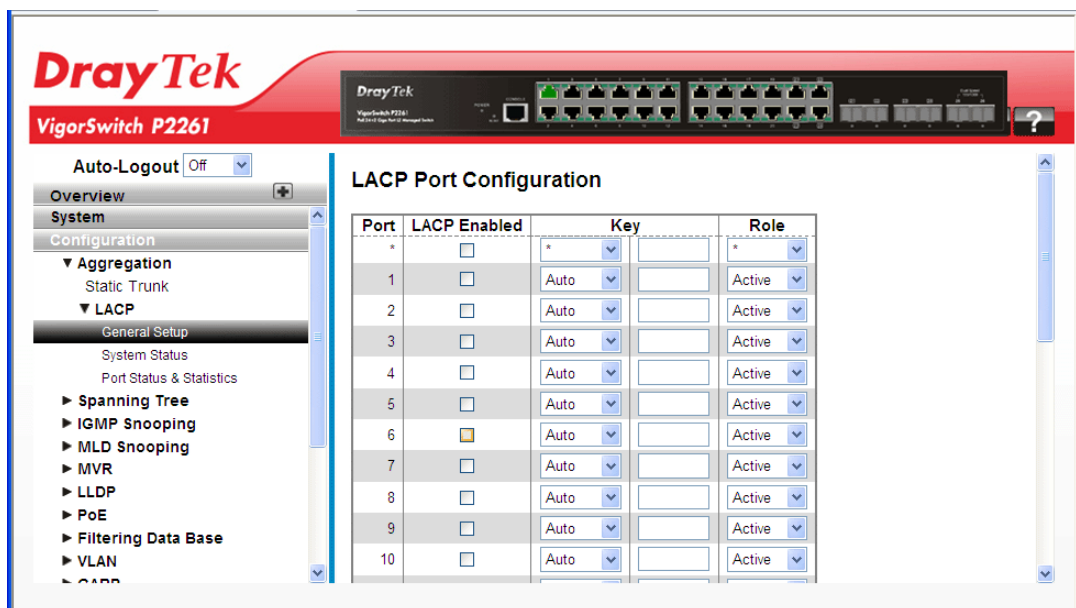

### Parameters description:

Port	The switch port number.
LACP Enabled	Controls whether LACP is enabled on this switch port. LACP will form an aggregation when 2 or more ports are connected to the same partner. LACP can form max 12 LLAGs per switch and 2 GLAGs per stack.
Key	The Key value incurred by the port, range 1-65535. The Auto setting will set the key as appropriate by the physical link speed, 10Mb = 1, 100Mb = 2, 1Gb = 3. Using the Specific setting, a user-defined value can be entered. Ports with the same Key value can participate in the same aggregation group, while ports with different keys cannot.
Role	The Role shows the LACP activity status. The Active will transmit LACP packets each second while Passive will wait for a LACP packet from a partner (speak if spoken to).

After finished the above settings, click **Apply** to save the configuration. The settings will take effect.

### 2.3.3 Aggregation – LACP – System Status

**Function name:**

Aggregation – LACP – System Status

**Function description:**

The function describes that when you complete to set LACP function on the switch then it provides a status overview for all LACP instances.

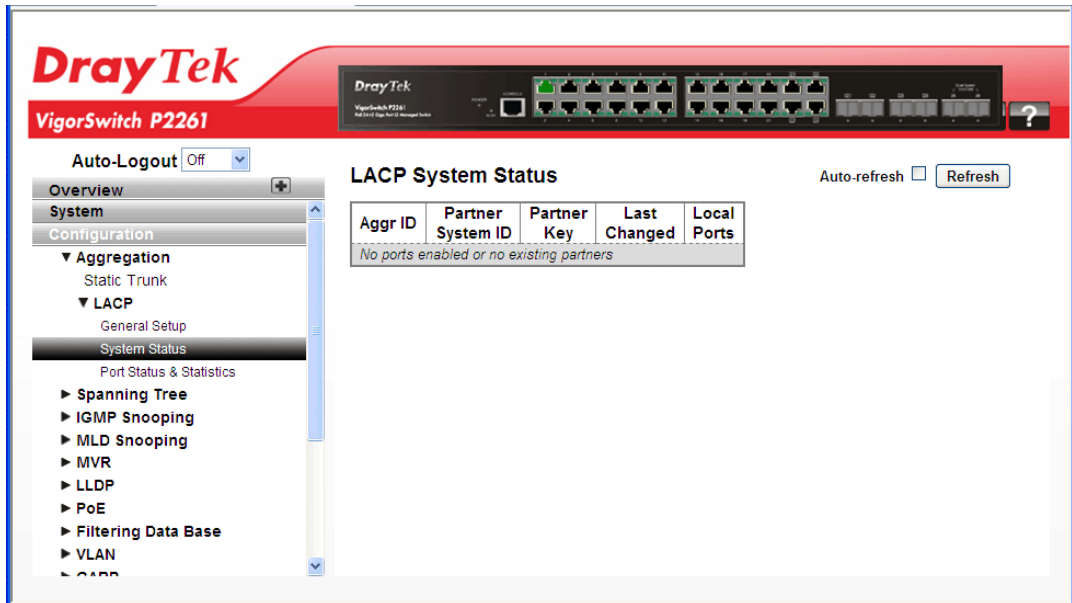

**Parameters description:**

Aggr ID	The Aggregation ID associated with this aggregation instance. For LLAG the id is shown as 'isid:aggr-id' and for GLAGs as 'aggr-id'.
Partner System ID	The system ID (MAC address) of the aggregation partner.
Partner Key	The Key that the partner has assigned to this aggregation ID.
Last changed	The time since this aggregation changed.
Local Ports	Shows which ports are a part of this aggregation for this switch/stack. The format is: "Switch ID:Port".
Auto refresh	The simple counts will be refreshed automatically on the UI screen.
Refresh	The simple counts will be refreshed manually when user use mouse to click on “Refresh” button.

After finished the above settings, click **Apply** to save the configuration. The settings will take effect.



## 2.3.4 Aggregation –LACP – Port Status & Statistics

### Function name:

Aggregation –LACP – Port Status & Statistics

### Function description:

The function shows a Port Status and Statistics overview for all LACP instances when you complete to set LACP function on the switch.

### Parameters description:

Port	The switch port number.
LCAP	'Yes' means that LACP is enabled and the port link is up. 'No' means that LACP is not enabled or that the port link is down. 'Backup' means that the port could not join the aggregation group but will join if other port leaves. Meanwhile its LACP status is disabled.
Key	The key assigned to this port. Only ports with the same key can aggregate together.
Aggr ID	The Aggregation ID assigned to this aggregation group. IDs 1 and 2 are GLAGs while IDs 3-14 are LLAGs.
Partner System ID	The partner's System ID (MAC address).
Partner Port	The partner's port number connected to this port.
LACP Received	Shows how many LACP frames have been received at each port.
LACP Transmitted	Shows how many LACP frames have been sent from each port.
Discarded	Shows how many unknown or illegal LACP frames have been discarded at each port.
Auto refresh	The simple counts will be refreshed automatically on the UI screen.

Refresh	The simple counts will be refreshed manually when user use mouse to click on “Refresh” button.
---------	--

After finished the above settings, click **Apply** to save the configuration. The settings will take effect.

### 2.3.5 Spanning Tree – Bridge Settings

The Spanning Tree Protocol (STP) can be used to detect and disable network loops, and to provide backup links between switches, bridges or routers. This allows the switch to interact with other bridging devices (that is, an STP-compliant switch, bridge or router) in your network to ensure that only one route exists between any two stations on the network, and provide backup links which automatically take over when a primary link goes down.

**STP** - STP uses a distributed algorithm to select a bridging device (STP- compliant switch, bridge or router) that serves as the root of the spanning tree network. It selects a root port on each bridging device (except for the root device) which incurs the lowest path cost when forwarding a packet from that device to the root device. Then it selects a designated bridging device from each LAN which incurs the lowest path cost when forwarding a packet from that LAN to the root device. All ports connected to designated bridging devices are assigned as designated ports. After determining the lowest cost spanning tree, it enables all root ports and designated ports, and disables all other ports. Network packets are therefore only forwarded between root ports and designated ports, eliminating any possible network loops.

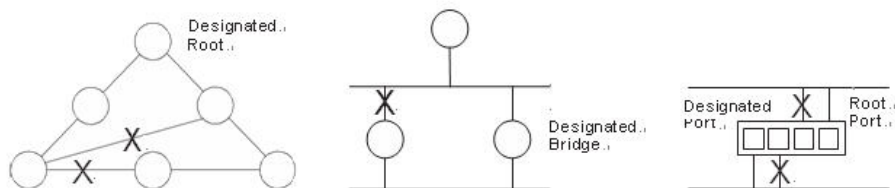

Once a stable network topology has been established, all bridges listen for Hello **BPDU** (**Bridge Protocol Data Units**) transmitted from the Root Bridge. If a bridge does not get a Hello BPDU after a predefined interval (Maximum Age), the bridge assumes that the link to the Root Bridge is down. This bridge will then initiate negotiations with other bridges to reconfigure the network to reestablish a valid network topology.

**Function name:**

Spanning Tree – Bridge Settings

**Function description:**

The function is used to configure the Spanning Tree Bridge and STP System settings. It allows you to configure STP System settings are used by all STP Bridge instance in the Switch Stack.

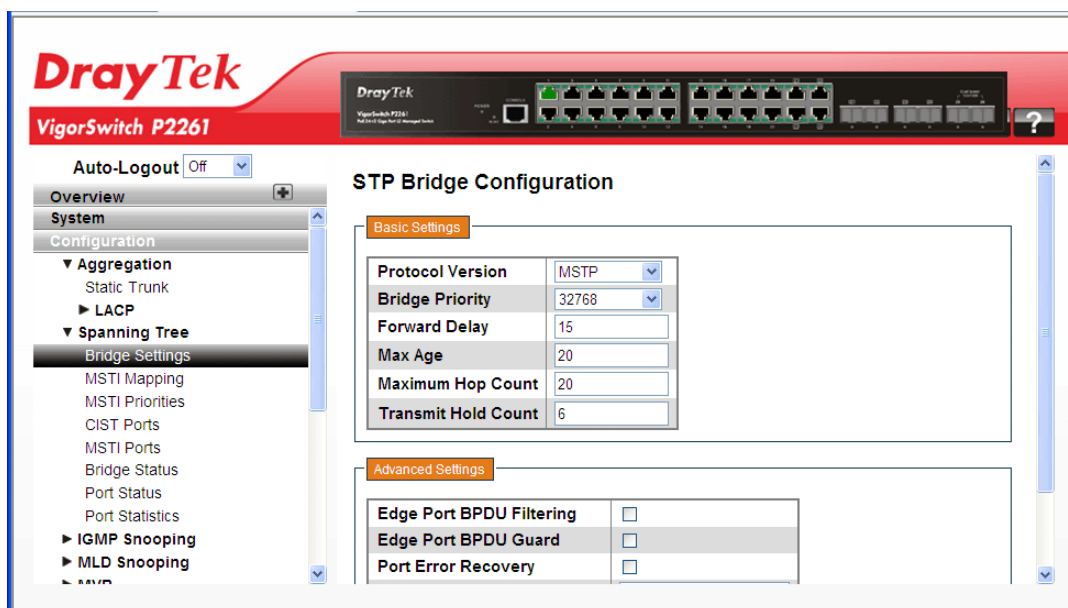

### Parameters description:

Basic Settings	
Protocol Version	The STP protocol version setting. Valid values are STP, RSTP and MSTP.
Bridge Priority	Controls the bridge priority. Lower numeric values have better priority. The bridge priority plus the MSTI instance number, concatenated with the 6-byte MAC address of the switch forms a <i>Bridge Identifier</i> . For MSTP operation, this is the priority of the CIST. Otherwise, this is the priority of the STP/RSTP bridge.
Forward Delay	The delay used by STP Bridges to transit Root and Designated Ports to Forwarding (used in STP compatible mode). Valid values are in the range 4 to 30 seconds.
Max Age	The maximum age of the information transmitted by the Bridge when it is the Root Bridge. Valid values are in the range 6 to 40 seconds, <i>and</i> MaxAge must be $\leq (FwdDelay-1)*2$ .
Maximum Hop Count	This defines the initial value of remaining Hops for MSTI information generated at the boundary of an MSTI region. It defines how many bridges a root bridge can distribute its BPDU information to. Valid values are in the range 6 to 40 hops.
Transmit Hold Count	The number of BPDU's a bridge port can send per second. When exceeded, transmission of the next BPDU will be delayed. Valid values are in the range 1 to 10 BPDU's per second.
Advanced Settings	
Edge Port BPDU Filtering	Control whether a port <i>explicitly</i> configured as Edge will transmit and receive BPDUs.
Edge Port BPDU Guard	Control whether a port <i>explicitly</i> configured as Edge will disable itself upon reception of a BPDU. The port will enter

	the <i>error-disabled</i> state, and will be removed from the active topology.
Port Error Recovery	Control whether a port in the <i>error-disabled</i> state automatically will be enabled after a certain time. If recovery is not enabled, ports have to be disabled and re-enabled for normal STP operation. The condition is also cleared by a system reboot.
Port Error Recovery Timeout	The time to pass before a port in the <i>error-disabled</i> state can be enabled. Valid values are between 30 and 86400 seconds (24 hours).

After finished the above settings, click **Apply** to save the configuration. The settings will take effect.

### 2.3.6 Spanning Tree – MSTI Mapping

When you implement a Spanning Tree protocol on the switch that the bridge instance, the CIST is not available for explicit mapping, as it will receive the VLANs not explicitly mapped. Due to the reason that you need to set the list of VLANs mapped to the MSTI, the VLANs must be separated with comma and/or space. A VLAN can only be mapped to one MSTI. An unused MSTI should just be left empty (i.e., not having any VLANs mapped to it).

**Function name:**

Spanning Tree – MSTI Mapping

**Function description:**

The function is used to inspect the current STP MSTI bridge instance priority configurations, and possibly change them as well.

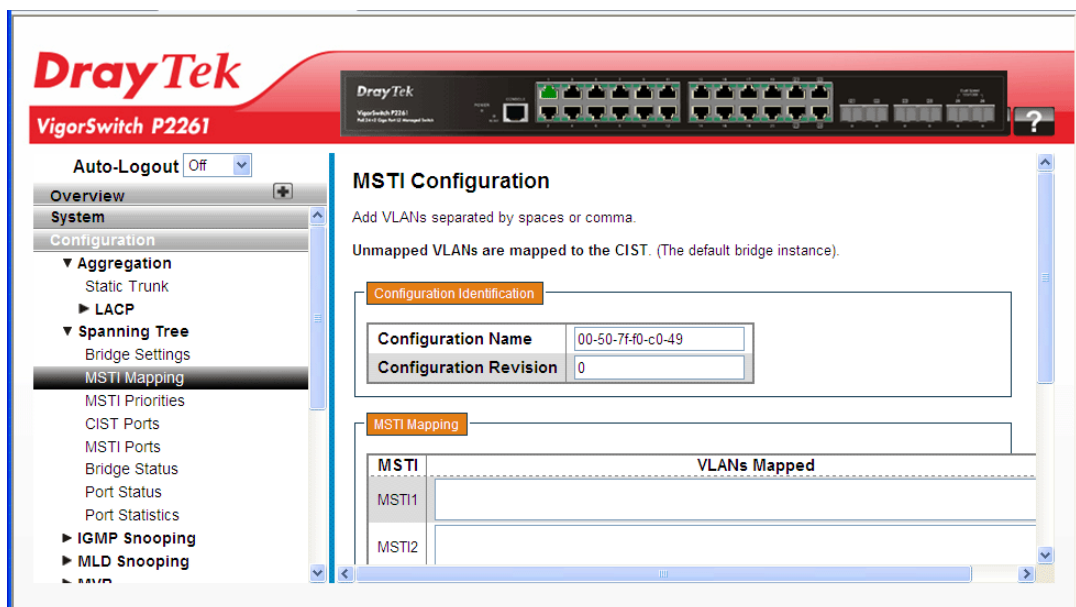

**Parameters description:**

Configuration Identification	
Configuration Name	The name identifying the VLAN to MSTI mapping. Bridges must share the name and revision (see below), as well as the VLAN-to-MSTI mapping configuration in order to share

	spanning trees for MSTI's (Intra-region). The name is at most 32 characters.
Configuration Revision	The revision of the MSTI configuration named above. This must be an integer between 0 and 65535.
<b>MSTI Mapping</b>	
MSTI	The bridge instance. The CIST is not available for explicit mapping, as it will receive the VLANs not explicitly mapped.
VLANs Mapped	The list of VLANs mapped to the MSTI. The VLANs must be separated with comma and/or space. A VLAN can only be mapped to one MSTI. An unused MSTI should just be left empty. (I.e. not having any VLANs

After finished the above settings, click **Apply** to save the configuration. The settings will take effect.

### 2.3.7 Spanning Tree – MSTI Priorities

When you implement a Spanning Tree protocol on the switch for the bridge instance, the CIST is the default instance which is always active. For controls the bridge priority. Lower numeric values have better priority. The bridge priority plus the MSTI instance number, concatenated with the 6-byte MAC address of the switch forms a Bridge Identifier.

**Function name:**

Spanning Tree – MSTI Priorities

**Function description:**

The function is used to inspect the current STP MSTI bridge instance priority configurations, and possibly change them as well.

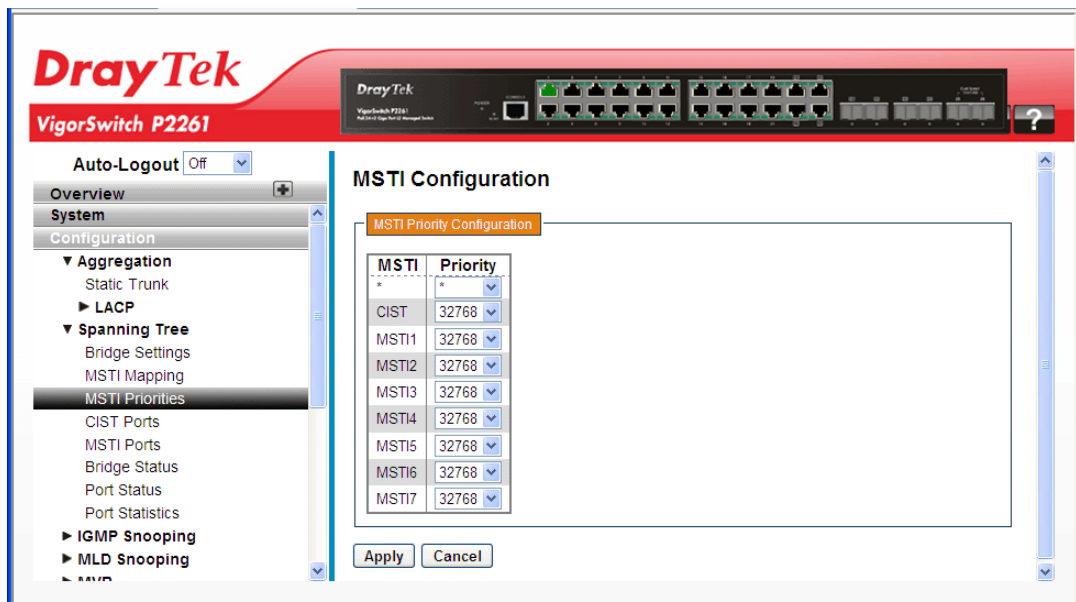

**Parameters description:**

MSTI	The bridge instance. The CIST is the default instance, which is always active.
Priority	Controls the bridge priority. <b>Lower numeric values have</b>

**better priority.** The bridge priority plus the MSTI instance number, concatenated with the 6-byte MAC address of the switch forms a Bridge Identifier.

After finished the above settings, click **Apply** to save the configuration. The settings will take effect.

### 2.3.8 Spanning Tree – CIST Ports

When you implement a Spanning Tree protocol on the switch for the bridge instance, you need to configure the CIST Ports.

**Function name:**

Aggregation – Static Trunk

**Function description:**

The function is used to inspect the current STP CIST port configurations, and possibly change them as well.

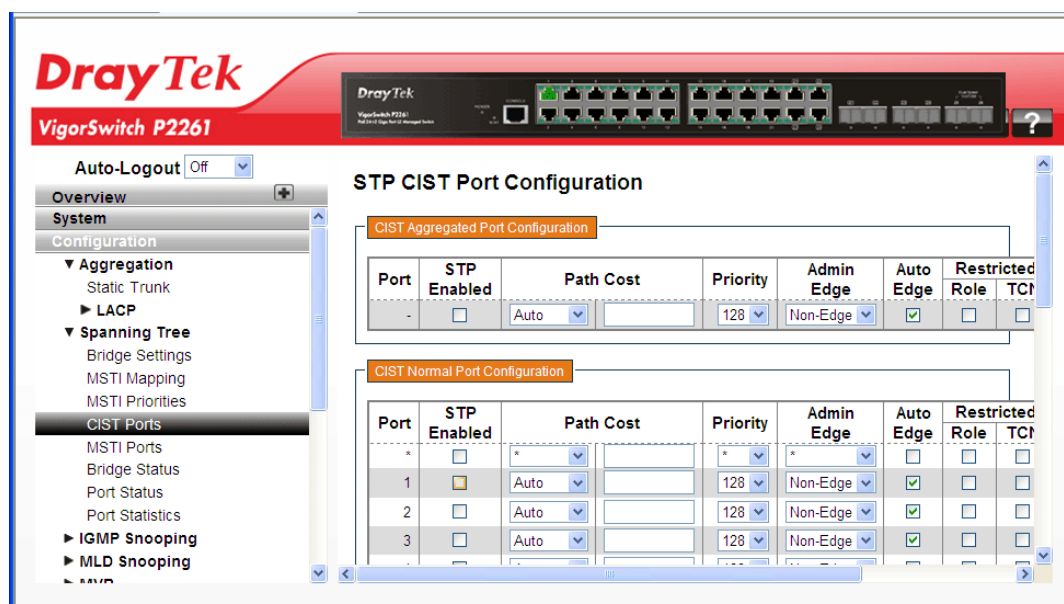

**Parameters description:**

Port	The switch port number of the logical STP port.
STP Enabled	Controls whether STP is enabled on this switch port.
Path Cost	Controls the path cost incurred by the port. The Auto setting will set the path cost as appropriate by the physical link speed, using the 802.1D recommended values. Using the Specific setting, a user-defined value can be entered. The path cost is used when establishing the active topology of the network. Lower path cost ports are chosen as forwarding ports in favour of higher path cost ports. Valid values are in the range 1 to 200000000.
Priority	Controls the port priority. This can be used to control priority of ports having identical port cost. (See above).
Admin Edge	Controls whether the <i>operEdge</i> flag should start as set or

	cleared. (The initial <i>operEdge</i> state when a port is initialized).
Auto Edge	Controls whether the bridge should enable automatic edge detection on the bridge port. This allows <i>operEdge</i> to be derived from whether BPDU's are received on the port or not.
Restricted Role	If enabled, causes the port not to be selected as Root Port for the CIST or any MSTI, even if it has the best spanning tree priority vector. Such a port will be selected as an Alternate Port after the Root Port has been selected. If set, it can cause lack of spanning tree connectivity. It can be set by a network administrator to prevent bridges external to a core region of the network influence the spanning tree active topology, possibly because those bridges are not under the full control of the administrator. This feature is also known as Root Guard.
Restricted TCN	If enabled, causes the port not to propagate received topology change notifications and topology changes to other ports. If set it can cause temporary loss of connectivity after changes in a spanning tree's active topology as a result of persistently incorrect learned station location information. It is set by a network administrator to prevent bridges external to a core region of the network, causing address flushing in that region, possibly because those bridges are not under the full control of the administrator or the physical link state of the attached LANs transits frequently.
BPDU Guard	If enabled, causes the port to disable itself upon receiving valid BPDU's. Contrary to the similar bridge setting, the port Edge status does not affect this setting. A port entering error-disabled state due to this setting is subject to the bridge Port Error Recovery setting as well.
Point-to-point	Controls whether the port connects to a point-to-point LAN rather than to a shared medium. This can be automatically determined, or forced either true or false. Transition to the forwarding state is faster for point-to-point LANs than for shared media.

After finished the above settings, click **Apply** to save the configuration. The settings will take effect.

## 2.3.9 Spanning Tree – MSTI Ports

An MSTI port is a virtual port, which is instantiated separately for each active CIST (physical) port for each MSTI instance configured on and applicable to the port. The MSTI instance must be selected before displaying actual MSTI port configuration options. It contains MSTI port settings for physical and aggregated ports. The aggregation settings are stack global.

**Function name:**

Spanning Tree – MSTI Ports

**Function description:**

The function is used to inspect the current STP MSTI port configurations, and possibly change them as well.

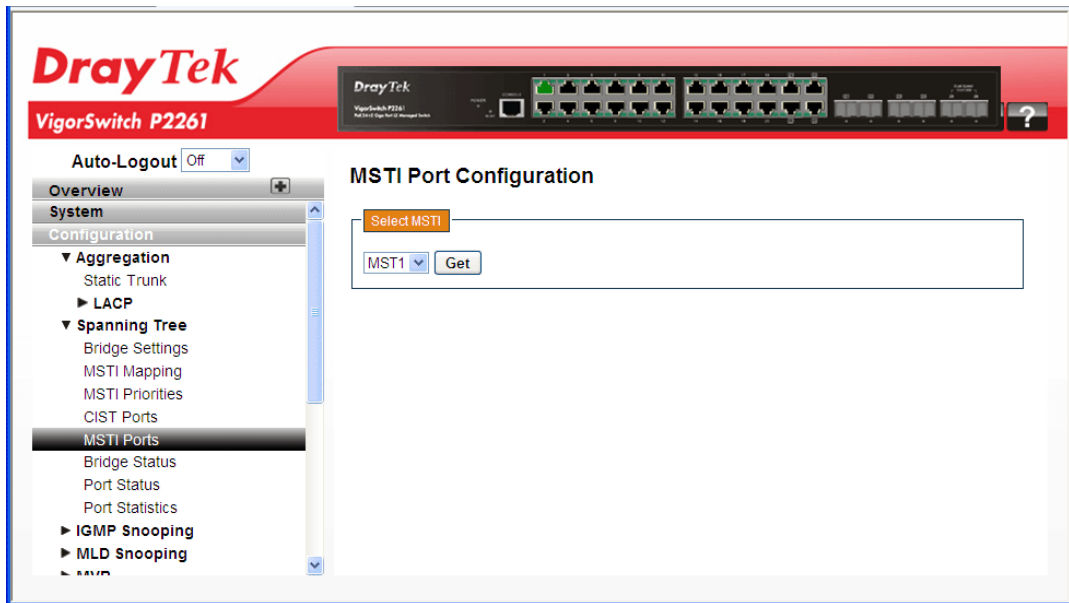

Use the drop down list to choose one of the MSTI ports and click **Get** to open the following page:

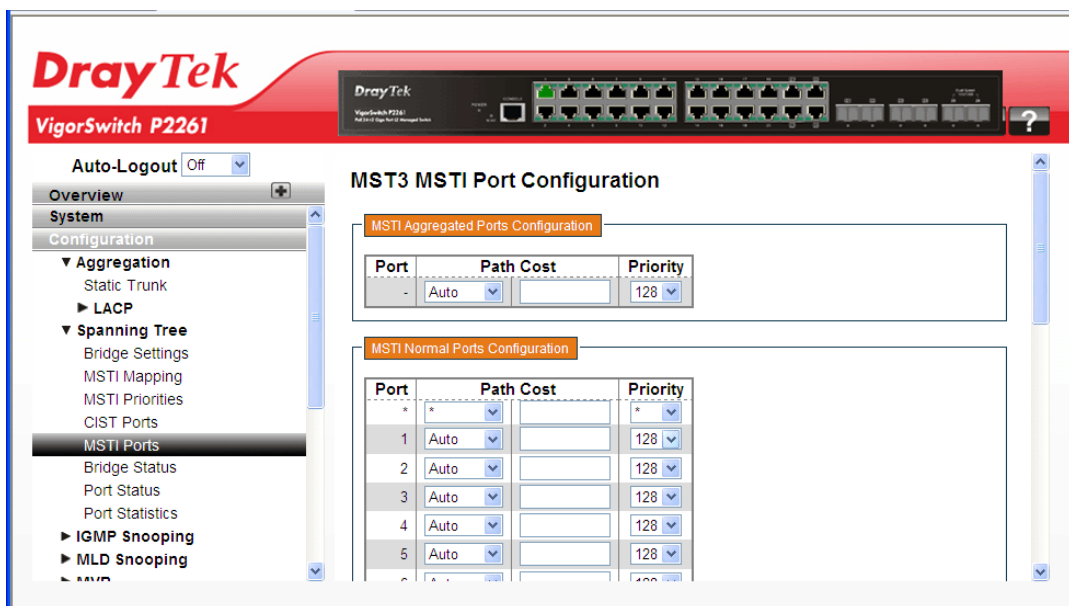

**Parameters description:**



Port	The switch port number of the corresponding STP CIST (and MSTI) port.
Path Cost	Controls the path cost incurred by the port. The Auto setting will set the path cost as appropriate by the physical link speed, using the 802.1D recommended values. Using the Specific setting, a user-defined value can be entered. The path cost is used when establishing the active topology of the network. Lower path cost ports are chosen as forwarding ports in favour of higher path cost ports. Valid values are in the range 1 to 200000000.
Priority	Controls the port priority. This can be used to control priority of ports having identical port cost. (See above).

After finished the above settings, click **Apply** to save the configuration. The settings will take effect.

### 2.3.10 Spanning Tree – Bridge Status

After you complete the MSTI Port configuration, you could to ask the switch display the Bridge Status.

**Function name:**

Spanning Tree – Bridge Status

**Function description:**

The function is used to provide a status overview of all STP bridge instances. The displayed table contains a row for each STP bridge instance, where the column displays the following information:

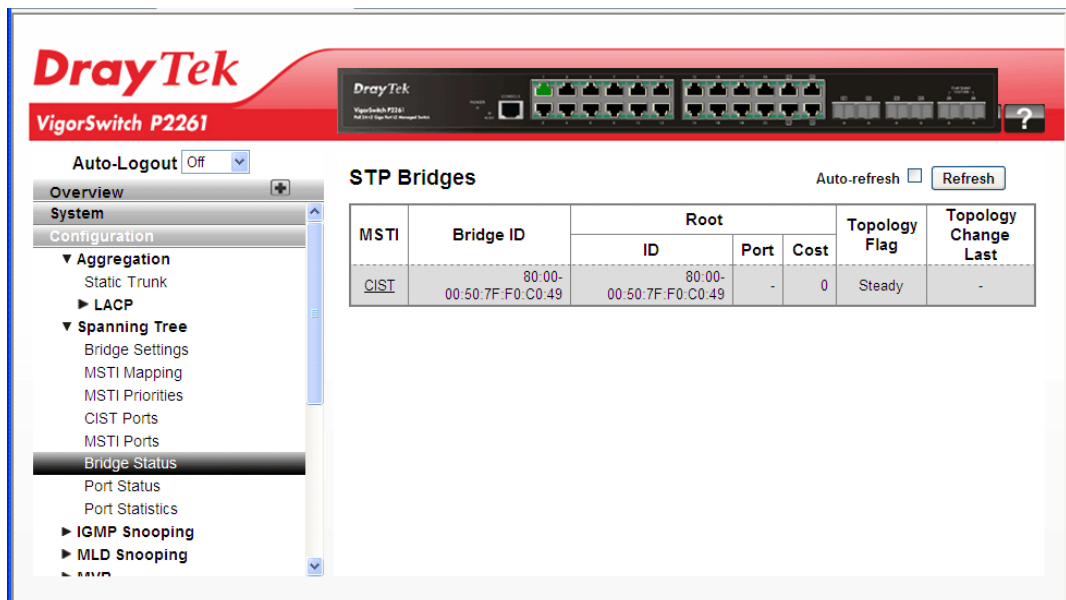

**Parameters description:**

MSTI	The Bridge Instance. This is also a link to the STP Detailed Bridge Status.
Bridge ID	The Bridge ID of this Bridge instance.
Root ID	The Bridge ID of the currently elected root bridge.

Root Port	The switch port currently assigned the root port role.
Root Cost	Root Path Cost. For the Root Bridge it is zero. For all other Bridges, it is the sum of the Port Path Costs on the least cost path to the Root Bridge.
Topology Flag	The current state of the Topology Change Flag of this Bridge instance.
Topology Change Last	The time since last Topology Change occurred.

### 2.3.11 Spanning Tree – Port Status

After you complete the STP configuration, you could to ask the switch display the STP Port Status.

**Function name:**

Spanning Tree – Port Status

**Function description:**

The function is used to ask the switch to display the STP CIST port status for physical ports of the currently selected switch.

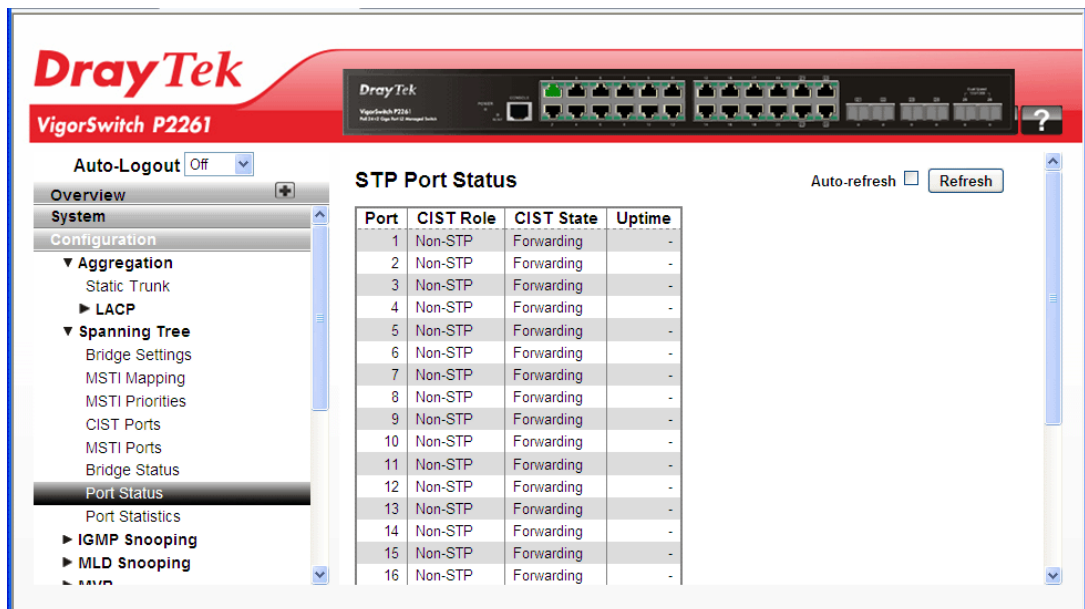

**Parameters description:**

Port	The switch port number of the logical STP port.
CIST Role	The current STP port role of the CIST port. The port role can be one of the following values: Alternate Port, Backup Port, Root Port, Designated Port, Disabled.
CIST State	The current STP port state of the CIST port. The port state can be one of the following values: Blocking, Learning, Forwarding.
Uptime	The time since the bridge port was last initialized.
Auto refresh	The simple counts will be refreshed automatically on the UI screen.

Refresh	The simple counts will be refreshed manually when user use mouse to click on “Refresh” button.
---------	--

### 2.3.12 Spanning Tree – Port Statistics

After you complete the STP configuration, you could to let the switch display the STP Statistics.

**Function name:**

Spanning Tree – Port Statistics

**Function description:**

The function is used to ask switch to display the STP Statistics detail counters of bridge ports in the currently selected switch.

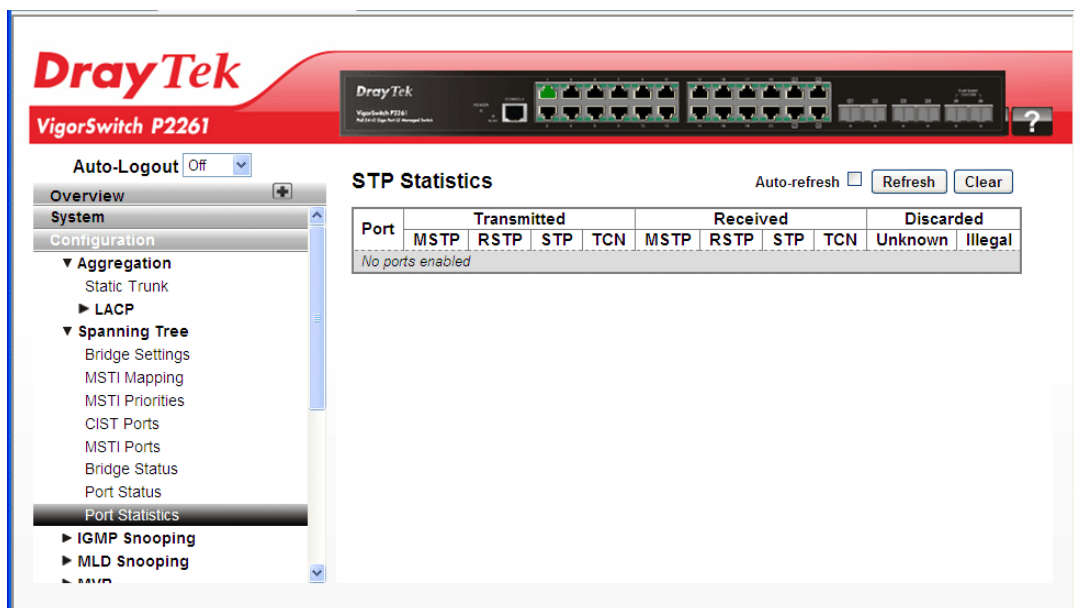

**Parameters description:**

Port	The switch port number of the logical STP port.
MSTP	The number of MSTP Configuration BPDU's received/transmitted on the port.
RSTP	The number of RSTP Configuration BPDU's received/transmitted on the port.
STP	The number of legacy STP Configuration BPDU's received/transmitted on the port.
TCN	The number of (legacy) Topology Change Notification BPDU's received/transmitted on the port.
Discarded Unknown	The number of unknown Spanning Tree BPDU's received (and discarded) on the port.
Discarded Illegal	The number of illegal Spanning Tree BPDU's received (and discarded) on the port.
Auto refresh	The simple counts will be refreshed automatically on the UI screen.
Refresh	The simple counts will be refreshed manually when user

	use mouse to click on “Refresh” button.
Clear	The simple counts will be reset to zero when user use mouse to click on “Clear” button.

### 2.3.13 IGMP Snooping – General Setup

A switch supported IGMP Snooping with the functions of query, report and leave, a type of packet exchanged between IP Multicast Router/Switch and IP Multicast Host, can update the information of the Multicast table when a member (port) joins or leaves an IP Multicast Destination Address. With this function, once a switch receives an IP multicast packet, it will forward the packet to the members who joined in a specified IP multicast group before.

The packets will be discarded by the IGMP Snooping if the user transmits multicast packets to the multicast group that had not been built up in advance. IGMP mode enables the switch to issue IGMP function that you enable IGMP proxy or snooping on the switch, which connects to a router closer to the root of the tree. This interface is the upstream interface. The router on the upstream interface should be running IGMP.

IGMP Snooping is used to establish the multicast groups to forward the multicast packet to the member ports, and, in nature, avoids wasting the bandwidth while IP multicast packets are running over the network. This is because a switch that does not support IGMP or IGMP Snooping can not tell the multicast packet from the broadcast packet, so it can only treat them all as the broadcast packet. Without IGMP Snooping, the multicast packet forwarding function is plain and nothing is different from broadcast packet.

**Function name:**

IGMP Snooping – General Setup

**Function description:**

The function is used to set the basic IGMP snooping on the switch, which connects to a router closer to the root of the tree. This interface is the upstream interface. The router on the upstream interface should be running IGMP.

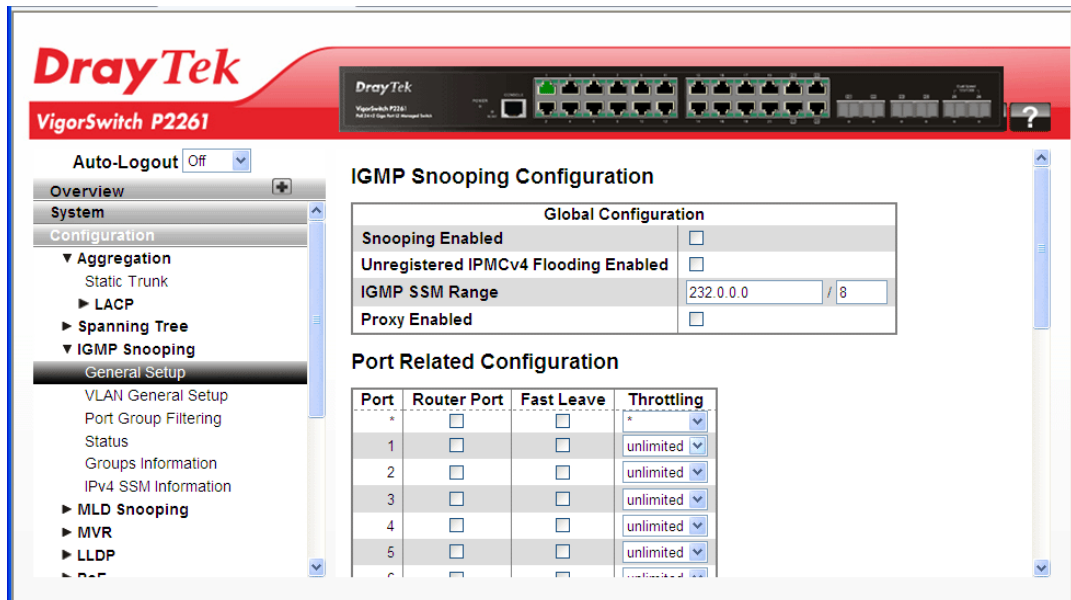

**Parameters description:**

Global Configuration	
Snooping Enabled	Enable the Global IGMP Snooping.

Unregistered IPMC Flooding enabled	Enable unregistered IPMC traffic flooding.
IGMP SSM Range	SSM (Source-Specific Multicast) Range allows the SSM-aware hosts and routers run the SSM service model for the groups in the address range. Format: (IP address/ sub mask)
Proxy Enabled	Enable IGMP Proxy. This feature can be used to avoid forwarding unnecessary join and leave messages to the router side.
Port Related Configuration	
Port	The switch port number.
Router Port	Specify which ports act as router ports. A router port is a port on the Ethernet switch that leads towards the Layer 3 multicast device or IGMP querier. If an aggregation member port is selected as a router port, the whole aggregation will act as a router port.
Fast Leave	Enable the fast leave on the port.
Throttling	Enable to limit the number of multicast groups to which a switch port can belong.

After finished the above settings, click **Apply** to save the configuration. The settings will take effect.

## 2.3.14 IGMP Snooping – VLAN General Setup

### Function name:

IGMP Snooping – VLAN General Setup

### Function description:

The section describes the VLAN configuration setting process integrated with IGMP Snooping function. For each setting page shows up to 99 entries from the VLAN table, default being 20, selected through the "entries per page" input field. When first visited, the web page will show the first 20 entries from the beginning of the VLAN Table. The first displayed will be the one with the lowest VLAN ID found in the VLAN Table. The "VLAN" input fields allow the user to select the starting point in the VLAN Table. Clicking the button will update the displayed table starting from that or the next closest VLAN Table match.

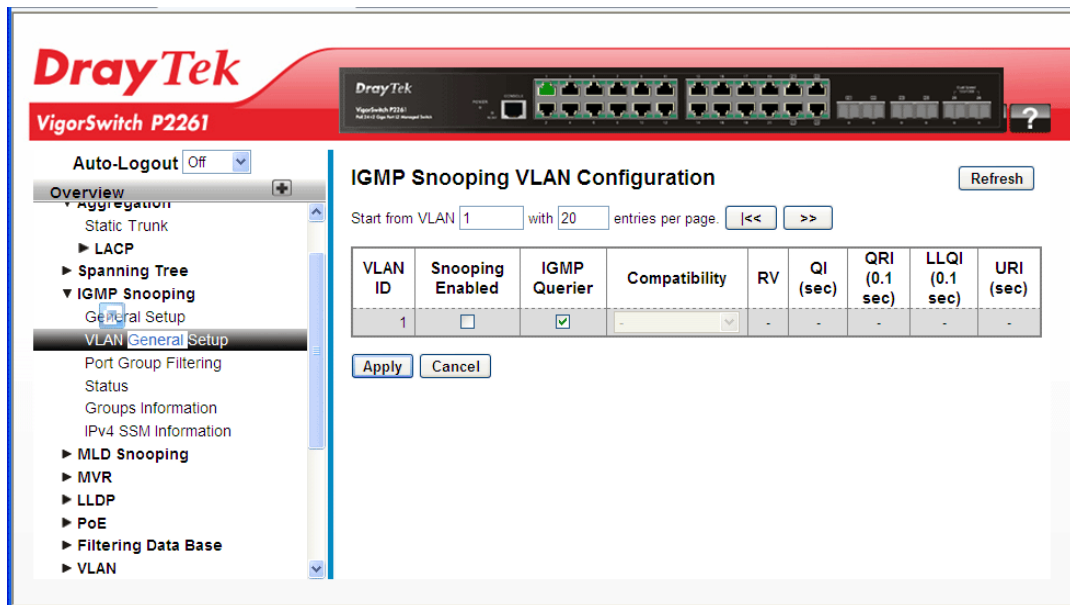

### Parameters description:

VLAN ID	The VLAN ID of the entry.
Snooping Enabled	Enable the per-VLAN IGMP Snooping.
IGMP Querier	Enable the IGMP Querier in the VLAN.
Compatibility	Compatibility is maintained by hosts and routers taking appropriate actions depending on the versions of IGMP operating on hosts and routers within a network. The allowed selection is IGMP-Auto, Forced IGMPv1, Forced IGMPv2, Forced IGMPv3, default compatibility value is IGMP-Auto.
RV	Robustness Variable. The Robustness Variable allows tuning for the expected packet loss on a link. The allowed range is 1 to 255; default robustness variable value is 2.
QI	Query Interval. The Query Interval variable denotes the interval between General Queries sent by the Querier. The allowed range is 1 to 255 seconds; default query interval is 125 seconds.
QRI	Query Response Interval. The Maximum Response Delay

	used to calculate the Maximum Response Code inserted into the periodic General Queries. The allowed range is 0 to 31744 in tenths of seconds; default query response interval is 100 in tenths of seconds (10 seconds).
LLQI	Last Listener Query Interval. The Last Listener Query Interval is the Maximum Response Delay used to calculate the Maximum Response Code inserted into Multicast Address Specific Queries sent in response to Version 1 Multicast Listener Done messages. It is also the Maximum Response Delay used to calculate the Maximum Response Code inserted into Multicast Address and Source Specific Query messages. The allowed range is 0 to 31744 in tenths of seconds; default last listener query interval is 10 in tenths of seconds (1 second).
URI	Unsolicited Report Interval. The Unsolicited Report Interval is the time between repetitions of a node's initial report of interest in a multicast address. The allowed range is 0 to 31744 seconds; default unsolicited report interval is 1 second.
Refresh	The simple counts will be refreshed manually when user use mouse to click on “Refresh” button.

After finished the above settings, click **Apply** to save the configuration. The settings will take effect.

### 2.3.15 IGMP Snooping – Port Group Filtering

With this feature, you can filter multicast joins on a per-port basis by configuring IP multicast profiles and associating them with individual switch ports. An IGMP profile can contain one or more multicast groups and specifies whether access to the group is permitted or denied. If an IGMP profile denying access to a multicast group is applied to a switch port, the IGMP join report requesting the stream of IP multicast traffic is dropped, and the port is not allowed to receive IP multicast traffic from that group. If the filtering action permits access to the multicast group, the IGMP report from the port is forwarded for normal processing.

IGMP filtering controls only IGMP membership join reports and has no relationship to the function that directs the forwarding of IP multicast traffic.

**Function name:**

IGMP Snooping – Port Group Filtering

**Function description:**

The function is used to set the IGMP Port Group Filtering. With the IGMP filtering feature, a user can exert this type of control. In some network Application environments, as like the metropolitan or multiple-dwelling unit (MDU) installations, an user might want to control the multicast groups to which a user on a switch port can belong. It allows the user to control the distribution of multicast services, such as IP/TV, based on some type of subscription or service plan.

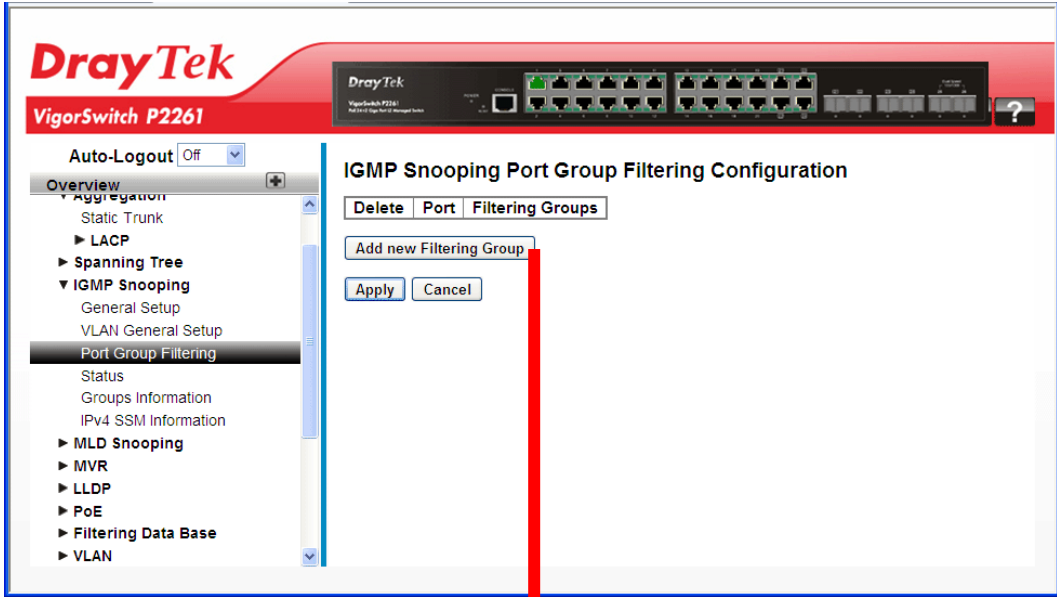



### Parameters description:

Delete	Click to delete the entry.
Port	The logical port for the settings.
Filtering Groups	The IP Multicast Group that will be filtered.
Add new Filtering Group	Click to add a new filtering group.

After finished the above settings, click **Apply** to save the configuration. The settings will take effect.

### 2.3.16 IGMP Snooping – Status

After you complete the IGMP Snooping configuration, you could to let the switch display the IGMP Snooping Status.

#### Function name:

IGMP Snooping – Status

#### Function description:

The function is used to let the switch to display the IGMP Snooping detail status.

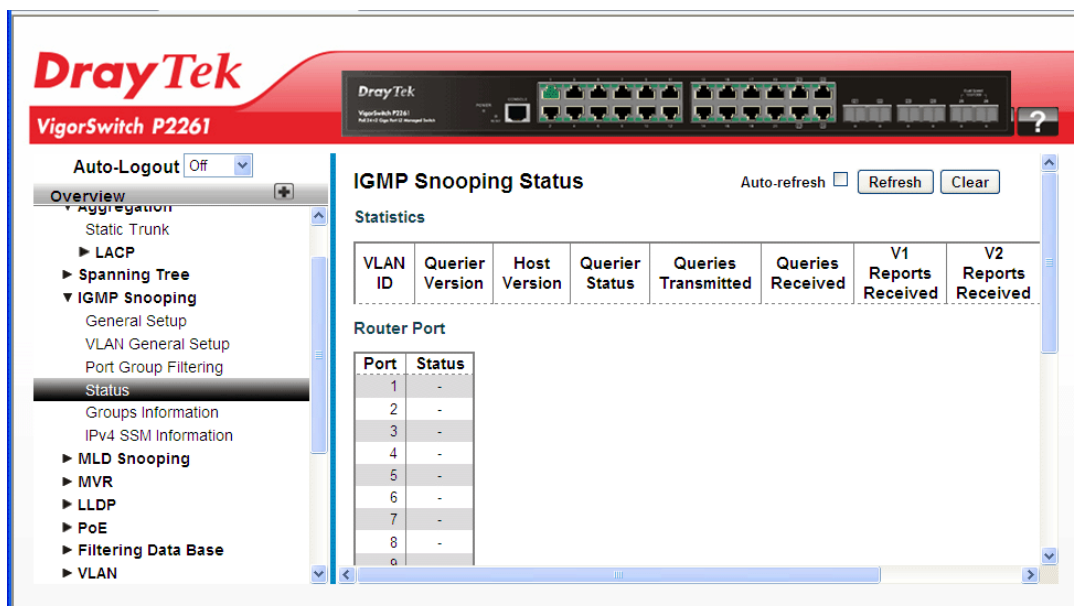

### Parameters description:

VLAN ID	The VLAN ID of the entry.
Querier Version	Working Querier Version currently.
Host Version	Working Host Version currently.
Querier Status	Shows the Querier status is "ACTIVE" or "IDLE".
Queries Transmitted	The number of Transmitted Queries.
Queries Received	The number of Received Queries.
V1 Reports Received	The number of Received V1 Reports.
V2 Reports Received	The number of Received V2 Reports.
V3 Reports Received	The number of Received V3 Reports.

V2 Leaves Received	The number of Received V2 Leaves.
Auto refresh	The simple counts will be refreshed automatically on the UI screen.
Refresh	The simple counts will be refreshed manually when user use mouse to click on “Refresh” button.
Clear	The simple counts will be reset to zero when user use mouse to click on “Clear” button.

After finished the above settings, click **Apply** to save the configuration. The settings will take effect.

### 2.3.17 IGMP Snooping – Groups Information

**Function name:**

IGMP Snooping – Groups Information

**Function description:**

After you complete to set the IGMP Snooping function then you could let the switch to display the IGMP Snooping Group Information. Entries in the IGMP Group Table are shown on this page. The IGMP Group Table is sorted first by VLAN ID, and then by group. The will use the last entry of the currently displayed table as a basis for the next lookup. When the end is reached the text "No more entries" is shown in the displayed table. Use the button to start over.

The "Start from VLAN", and "group" input fields allow the user to select the starting point in the IGMP Group Table. The will use the last entry of the currently displayed table as a basis for the next lookup. When the end is reached the text "No more entries" is shown in the displayed table.

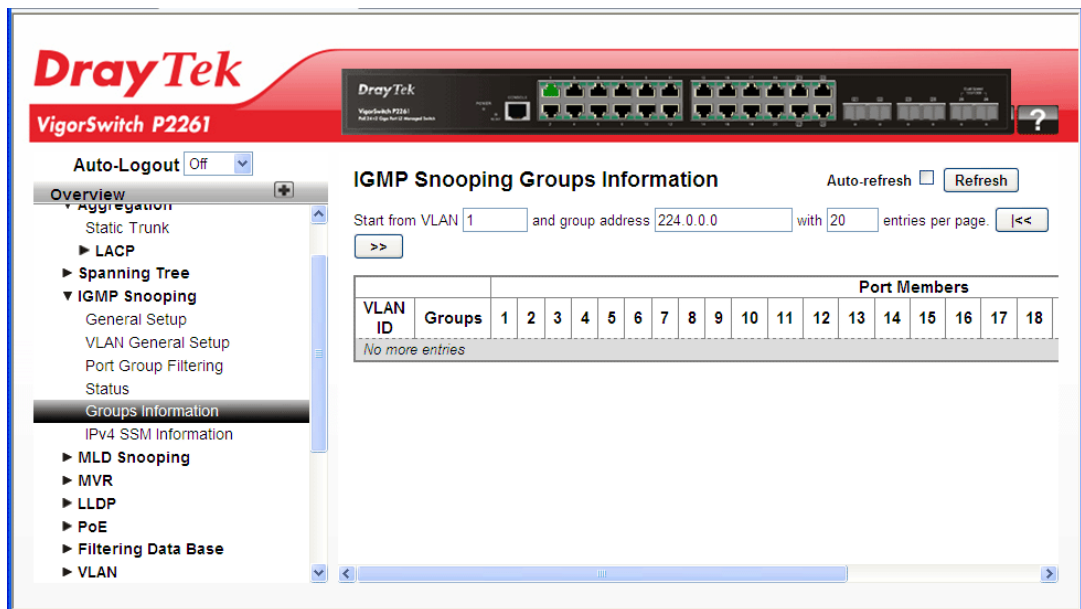

**Parameters description:**

VLAN ID	VLAN ID of the group.
Groups	Group address of the group displayed.
Port Members	Ports under this group.

Auto refresh	The simple counts will be refreshed automatically on the UI screen.
Refresh	The simple counts will be refreshed manually when user use mouse to click on “Refresh” button.

### 2.3.18 IGMP Snooping- IPv4 SSM Information

Source Specific Multicast (SSM) is a datagram delivery model that best supports one-to-many applications, also known as broadcast applications. SSM is a core network technology of IP multicast targeted for audio and video broadcast application environments.

For the SSM delivery mode, an IP multicast receiver host must use IGMP Version 3 (IGMPv3) to subscribe to channel (S, G). By subscribing to this channel, the receiver host is indicating that it wants to receive IP multicast traffic sent by source host S to group G. The network will deliver IP multicast packets from source host S to group G to all hosts in the network that have subscribed to the channel (S, G).

SSM does not require group address allocation within the network, only within each source host. Different applications running on the same source host must use different SSM groups. Different applications running on different source hosts can arbitrarily reuse SSM group addresses without causing any excess traffic on the network.

Addresses in the range 232.0.0.0/8 (232.0.0.0 to 232.255.255.255) are reserved for SSM by IANA. In the switch, you can configure SSM for arbitrary IP multicast addresses also.

**Function name:**

IGMP Snooping- IPv4 SSM Information

**Function description:**

The function is used to display the SFM information for the switch.

Each page shows up to 99 entries from the IGMPv3 SSM (Source Specific Multicast) Information table, default being 20, selected through the "entries per page" input field. When first visited, the web page will show the first 20 entries from the beginning of the IGMPv3 Information Table.

The "Start from VLAN", and "group" input fields allow the user to select the starting point in the IGMPv3 Information Table. Clicking the button will update the displayed table starting from that or the closest next IGMPv3 Information Table match. In addition, the two input fields will - upon a button click - assume the value of the first displayed entry, allowing for continuous refresh with the same start address.

The will use the last entry of the currently displayed table as a basis for the next lookup. When the end is reached the text "No more entries" is shown in the displayed table. Use the button to start over.

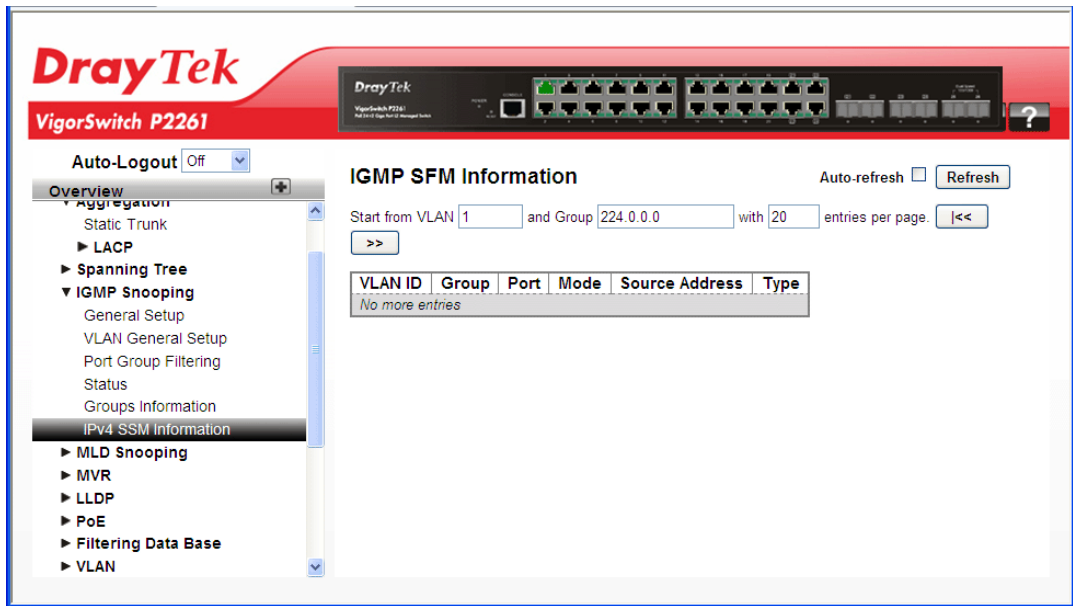

**Parameters description:**

VLAN ID	VLAN ID of the group.
Group	Group address of the group displayed.
Port	Switch port number.
Mode	Indicates the filtering mode maintained per (VLAN ID, port number, Group Address) basis. It can be either Include or Exclude.
Source Address	IP Address of the source. Currently, system limits the total number of IP source addresses for filtering to be 128.
Type	Indicates the Type. It can be either Allow or Deny.
Auto refresh	The simple counts will be refreshed automatically on the UI screen.
Refresh	The simple counts will be refreshed manually when user use mouse to click on “Refresh” button.

**2.3.19 MLD Snooping – General Setup**

Curiously enough, a network node that acts as a source of IPv6 multicast traffic is only an indirect participant in MLD snooping—it just provides multicast traffic, and MLD doesn’t interact with it. (Note, however, that in an application like desktop conferencing a network node may act as both a source and an MLD host; but MLD interacts with that node only in its role as an MLD host.)

A source node creates multicast traffic by sending packets to a multicast address. In IPv6, addresses with the first eight bits set (that is, “FF” as the first two characters of the address) are multicast addresses, and any node that listens to such an address will receive the traffic sent to that address. Application software running on the source and destination systems cooperates to determine what multicast address to use. (Note that this is a function of the application software, not of MLD.)

When MLD snooping is enabled on a VLAN, the switch acts to minimize unnecessary multicast traffic. If the switch receives multicast traffic destined for a given multicast

address, it forwards that traffic only to ports on the VLAN that have MLD hosts for that address. It drops that traffic for ports on the VLAN that have no MLD hosts

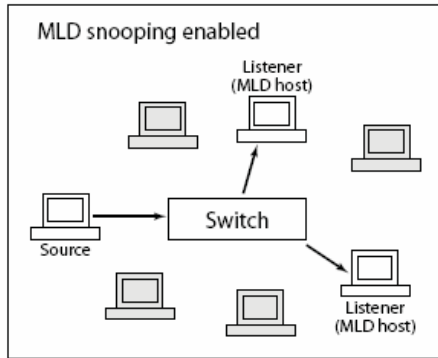

**Function name:**

MLD Snooping – General Setup

**Function description:**

The function is used to configure the MLD Snooping basic configuration and the parameters.

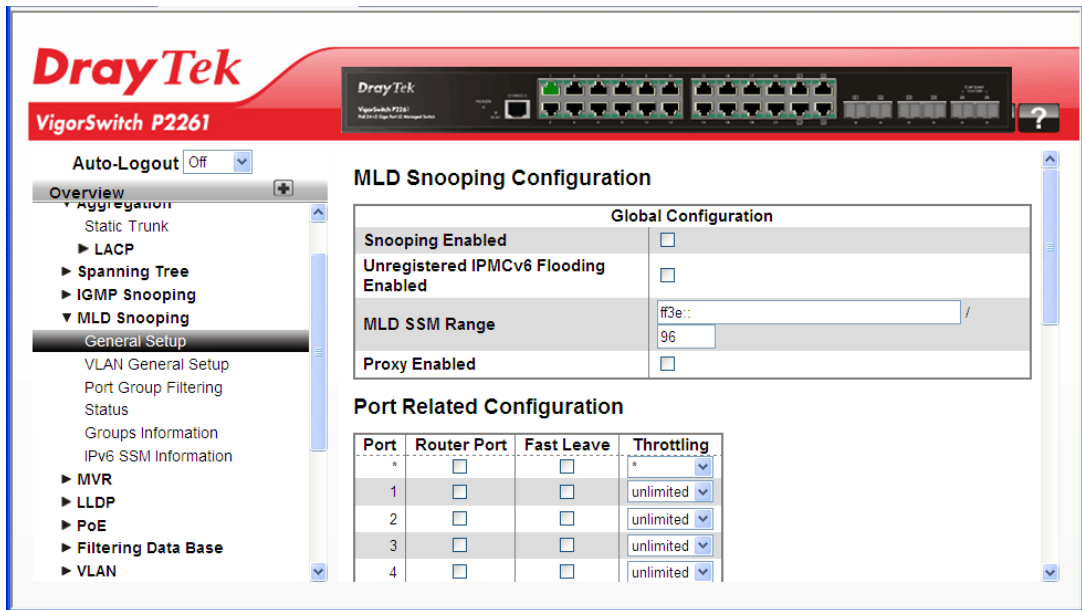

**Parameters description:**

MLD Snooping Configuration	
Snooping Enabled	Enable the Global MLD Snooping.
Unregistered IPMCv6 Flooding enabled	Enable unregistered IPMCv6 traffic flooding. Please note that disabling unregistered IPMCv6 traffic flooding may lead to failure of Neighbor Discovery.
MLD SSM Range	SSM (Source-Specific Multicast) Range allows the SSM-aware hosts and routers run the SSM service model for the groups in the address (Using IPv6 Address) range.
Proxy Enabled	Enable MLD Proxy. This feature can be used to avoid forwarding unnecessary join and leave messages to the router side.

Port Related Configuration	
Port	Switch port number.
Router Port	Specify which ports act as router ports. A router port is a port on the Ethernet switch that leads towards the Layer 3 multicast device or MLD querier. If an aggregation member port is selected as a router port, the whole aggregation will act as a router port.
Fast Leave	Enable the fast leave on the port.
Throttling	Enable to limit the number of multicast groups to which a switch port can belong.

After finished the above settings, click **Apply** to save the configuration. The settings will take effect.

## 2.3.20 MLD Snooping – VLAN General Setup

### Function name:

MLD Snooping – VLAN General Setup

### Function description:

When MLD snooping is enabled on a VLAN, the switch acts to minimize unnecessary multicast traffic. If the switch receives multicast traffic destined for a given multicast address, it forwards that traffic only to ports on the VLAN that have MLD hosts for that address. It drops that traffic for ports on the VLAN that have no MLD hosts

The will use the last entry of the currently displayed entry as a basis for the next lookup. When the end is reached the text "No more entries" is shown in the displayed table. Use the button to start over.

The screenshot shows the DrayTek VigorSwitch P2261 web interface. The main content area is titled "MLD Snooping VLAN Configuration" and includes a "Refresh" button. Below the title, there is a navigation bar with "Start from VLAN 1" and "with 20 entries per page." and navigation arrows. A table displays the configuration for VLAN 1:

VLAN ID	Snooping Enabled	MLD Querier	Compatibility	RV	QI (sec)	QRI (0.1 sec)	LLQI (0.1 sec)	URI (sec)
1	<input type="checkbox"/>	<input checked="" type="checkbox"/>	-	-	-	-	-	-

Below the table are "Apply" and "Cancel" buttons. The left navigation menu shows the following structure:

- Overview
  - Aggregation
    - Static Trunk
    - LACP
    - Spanning Tree
    - IGMP Snooping
    - MLD Snooping
      - General Setup
      - VLAN General Setup
      - Port Group Filtering
      - Status
      - Groups Information
      - IPv6 SSM Information
    - MVR
    - LLDP
    - PoE
    - Filtering Data Base
    - VLAN

**Parameters description:**

VLAN ID	The VLAN ID of the entry.
Snooping Enabled	Enable the per-VLAN MLD Snooping. Only up to 64 VLANs can be selected.
MLD Querier	Enable the IGMP Querier in the VLAN.
RV	Robustness Variable. The Robustness Variable allows tuning for the expected packet loss on a link. The allowed range is 1 to 255, default robustness variable value is 2.
QI	Query Interval. The Query Interval variable denotes the interval between General Queries sent by the Querier. The allowed range is 1 to 255 seconds; default query interval is 125 seconds.
QRI	Query Response Interval. The Maximum Response Delay used to calculate the Maximum Response Code inserted into the periodic General Queries. The allowed range is 0 to 31744 in tenths of seconds; default query response interval is 100 in tenths of seconds (10 seconds).
LLQI	Last Listener Query Interval. The Last Listener Query Interval is the Maximum Response Delay used to calculate the Maximum Response Code inserted into Multicast Address Specific Queries sent in response to Version 1 Multicast Listener Done messages. It is also the Maximum Response Delay used to calculate the Maximum Response Code inserted into Multicast Address and Source Specific Query messages. The allowed range is 0 to 31744 in tenths of seconds; default last listener query interval is 10 in tenths of seconds (1 second).
URI	Unsolicited Report Interval. The Unsolicited Report Interval is the time between repetitions of a node's initial report of interest in a multicast address. The allowed range is 0 to 31744 seconds; default unsolicited report interval is 1 second.
Refresh	The simple counts will be refreshed manually when user use mouse to click on “Refresh” button.

After finished the above settings, click **Apply** to save the configuration. The settings will take effect.

## 2.3.21 MLD Snooping – Port Group Filtering

**Function name:**

MLD Snooping – Port Group Filtering

**Function description:**

The function is used to set the Port Group Filtering in the MLD Snooping function. On the web page, that you could add a new filtering group and safety policy.

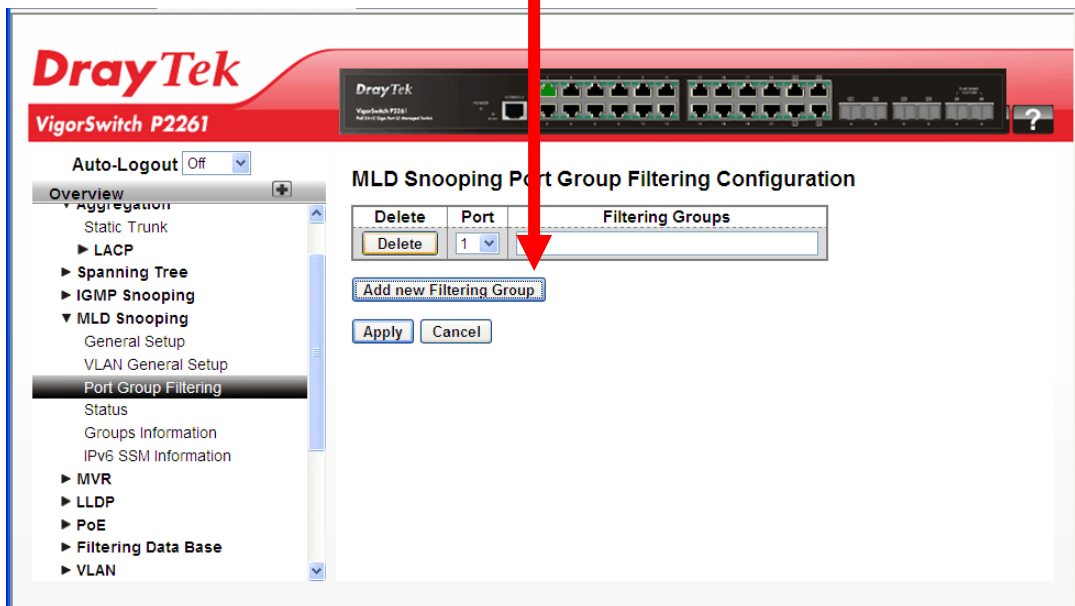
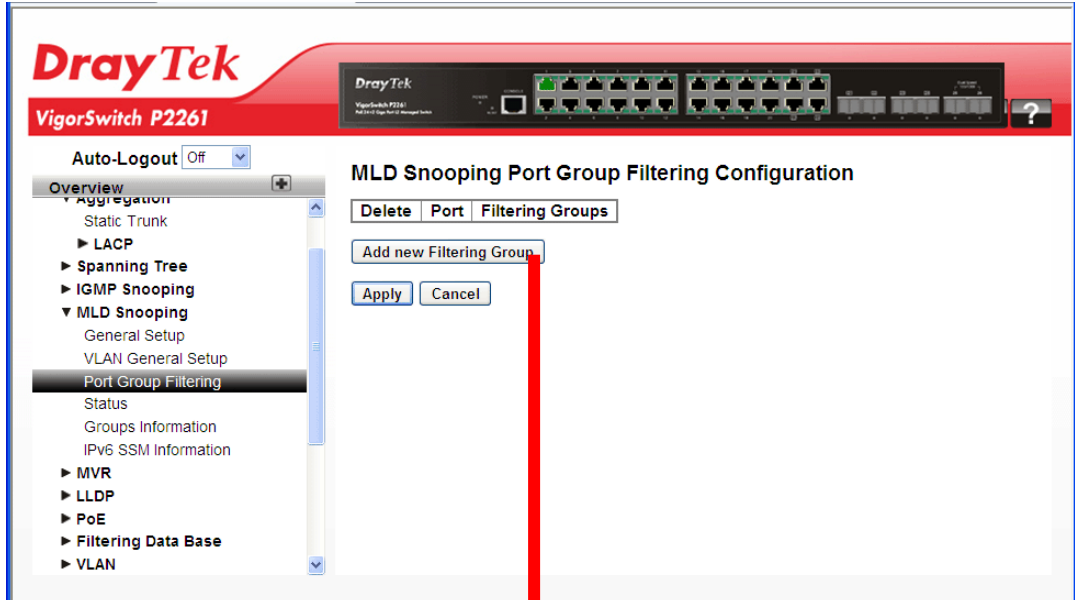

**Parameters description:**

Delete	Click to delete the entry.
Port	The logical port for the settings.
Filtering Groups	The IP Multicast Group that will be filtered.
Add new Filtering Group	Click to add a new filtering group.



After finished the above settings, click **Apply** to save the configuration. The settings will take effect.

### 2.3.22 MLD Snooping – Status

**Function name:**

MLD Snooping – Status

**Function description:**

The function is used to display the MLD Snooping Status and detail information.

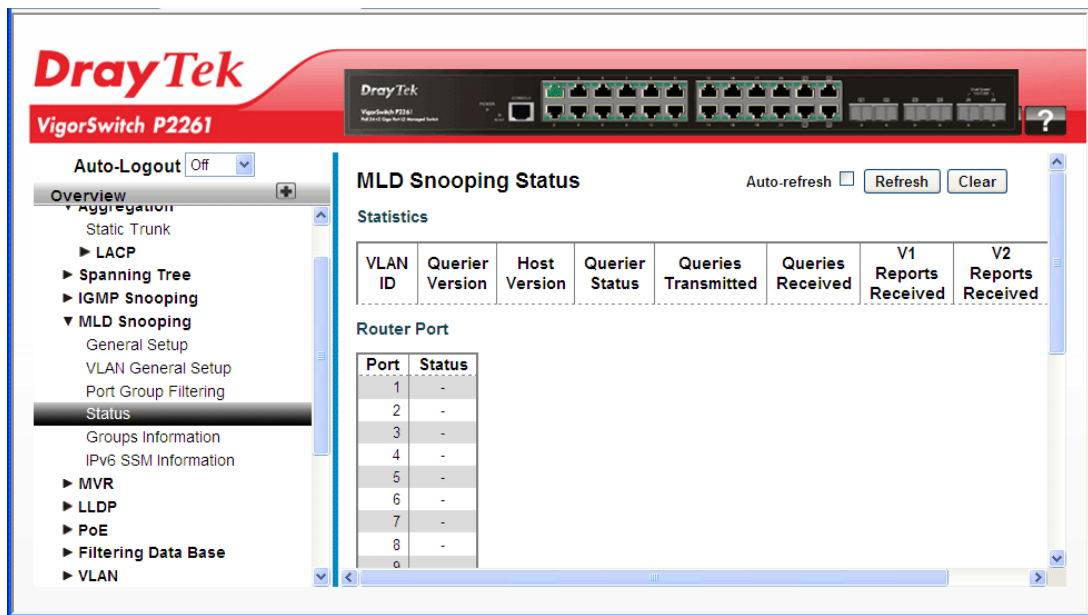

**Parameters description:**

VLAN ID	The VLAN ID of the entry.
Querier Version	Working Querier Version currently.
Host Version	Working Host Version currently.
Querier Status	Shows the Querier status is "ACTIVE" or "IDLE".
Queries Transmitted	The number of Transmitted Queries.
Queries Received	The number of Received Queries.
V1 Reports Received	The number of Received V1 Reports.
V2 Reports Received	The number of Received V2 Reports.
V3 Reports Received	The number of Received V3 Reports.
V2 Leaves Received	The number of Received V2 Leaves.
Auto refresh	The simple counts will be refreshed automatically on the UI screen.
Refresh	The simple counts will be refreshed manually when user use mouse to click on “Refresh” button.
Clear	The simple counts will be reset to zero when user use mouse to click on “Clear” button.

### 2.3.23 MLD Snooping – Groups Information

**Function name:**

MLD Snooping – Groups Information

**Function description:**

The function describes how a user could set the MLD Snooping Groups Information. The "Start from VLAN", and "group" input fields allow the user to select the starting point in the MLD Group Table.

Each page shows up to 99 entries from the MLD Group table, default being 20, selected through the "entries per page" input field. When first visited, the web page will show the first 20 entries from the beginning of the MLD Group Table. The "Start from VLAN", and "group" input fields allow the user to select the starting point in the MLD Group Table. Clicking the button will update the displayed table starting from that or the next closest MLD Group Table match. In addition, the two input fields will - upon a button click - assume the value of the first displayed entry, allowing for continuous refresh with the same start address. The will use the last entry of the currently displayed as a basis for the next lookup. When the end is reached the text "No more entries" is shown in the displayed table. Use the button to start over.

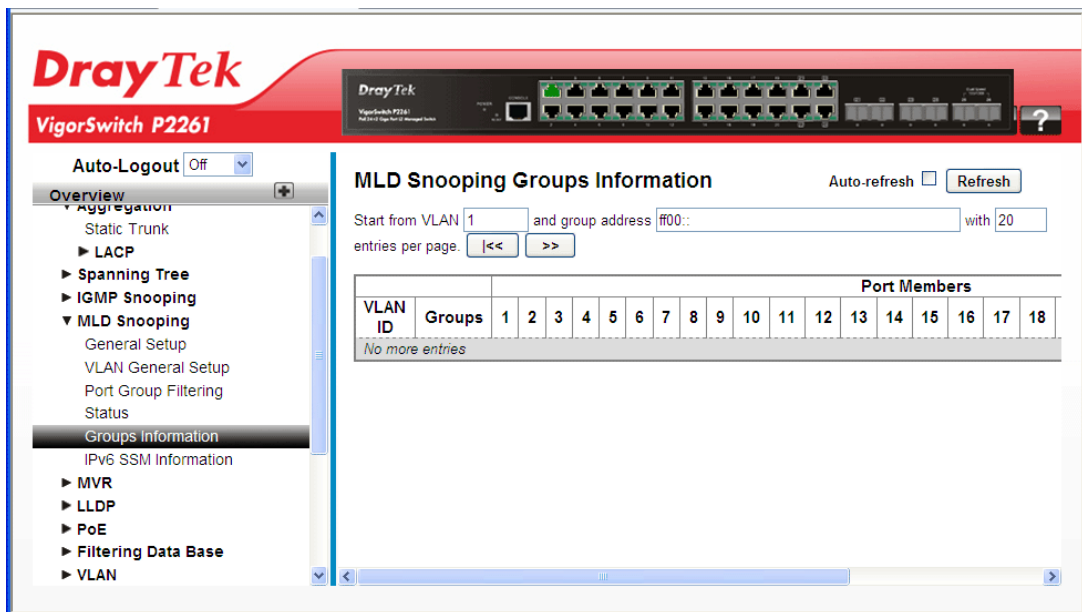

**Parameters description:**

VLAN ID	VLAN ID of the group.
Groups	Group address of the group displayed.
Port Members	Ports under this group.
Auto refresh	The simple counts will be refreshed automatically on the UI screen.
Refresh	The simple counts will be refreshed manually when user use mouse to click on “Refresh” button.

## 2.3.24 MLD Snooping- IPv6 SSM Information

**Function name:**

MLD Snooping- IPv6 SSM Information

**Function description:**

The section describes the user to configure the Entries in the MLDv2 Information Table are shown on this page. The MLDv2 Information Table is sorted first by VLAN ID, then by group, and then by Port No. Different source addresses belong to the same group are treated as single entry.

Each page shows up to 64 entries from the MLDv2 SSM (Source Specific Multicast) Information table, default being 20, selected through the "entries per page" input field. When first visited, the web page will show the first 20 entries from the beginning of the MLDv2 Information Table. The "Start from VLAN", and "group" input fields allow the user to select the starting point in the MLDv2 Information Table.

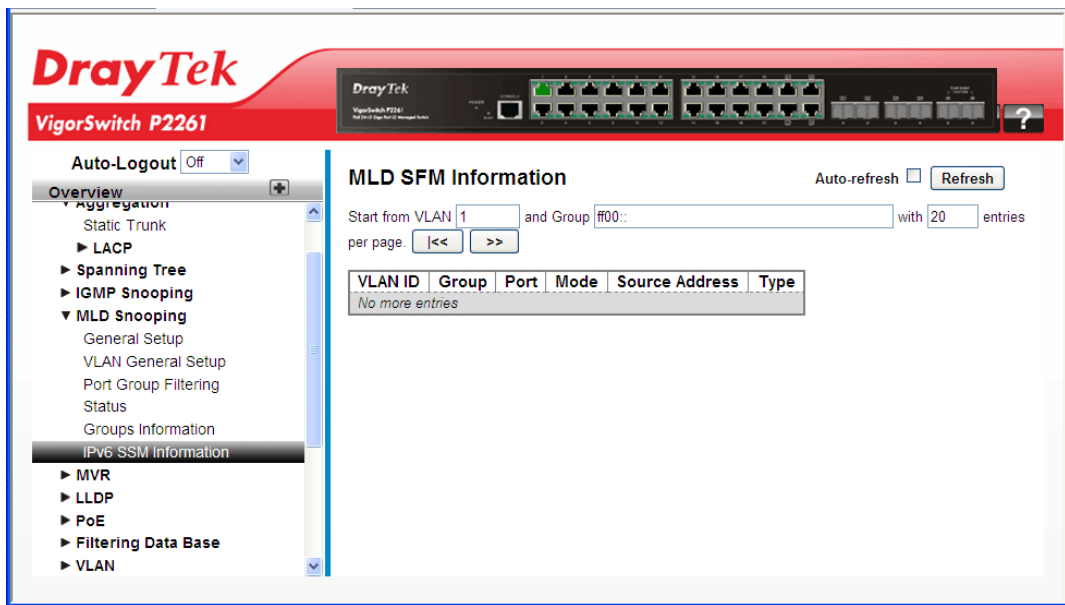

**Parameters description:**

VLAN ID	VLAN ID of the group.
Group	Group address of the group displayed.
Port	Switch port number.
Mode	Indicates the filtering mode maintained per (VLAN ID, port number, Group Address) basis. It can be either Include or Exclude.
Source Address	IP Address of the source. Currently, system limits the total number of IP source addresses for filtering to be 128.
Type	Indicates the Type. It can be either Allow or Deny.
Auto refresh	The simple counts will be refreshed automatically on the UI screen.
Refresh	The simple counts will be refreshed manually when user use mouse to click on "Refresh" button.

### 2.3.25 MVR – General Setup

The MVR feature enables multicast traffic forwarding on the Multicast VLAN. In a multicast television application, a PC or a television with a set-top box can receive the multicast stream. Multiple set-top boxes or PCs can be connected to one subscriber port, which is a switch port configured as an MVR receiver port. When a subscriber selects a channel, the set-top box or PC sends an IGMP join message to Switch A to join the appropriate multicast. Uplink ports that send and receive multicast data to and from the multicast VLAN are called MVR source ports.

**Function name:**

MVR – General Setup

**Function description:**

The function is used to set the MVR basic configuration and some parameters in the switch.

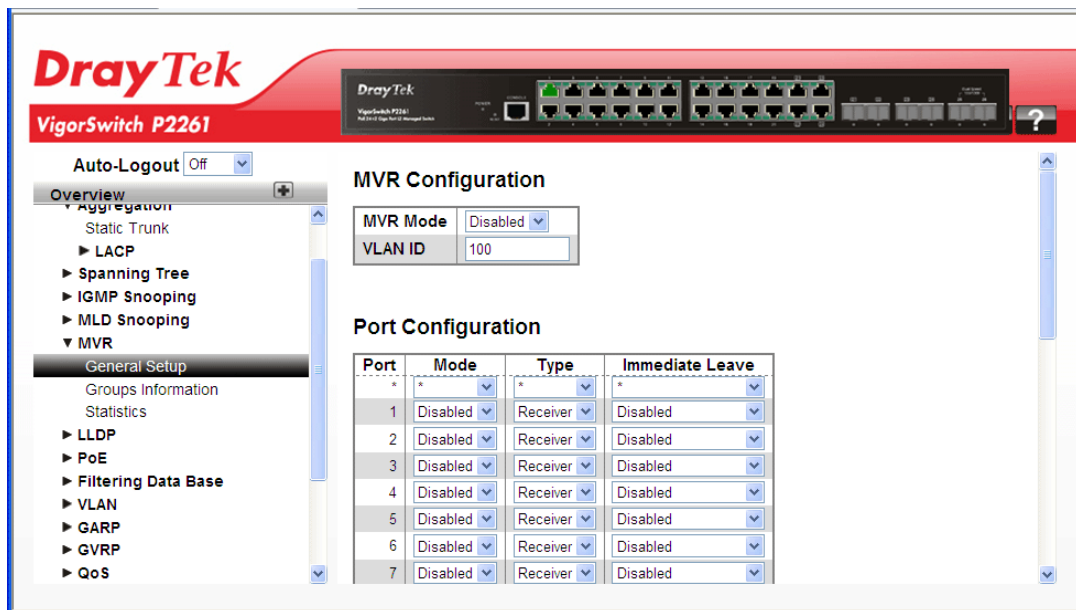

**Parameters description:**

MVR Mode	Enable/Disable the Global MVR.
VLAN ID	Specify the Multicast VLAN ID.
Port	Switch port number.
Mode	Enable MVR on the port.
Type	Specify the MVR port type on the port.
Immediate Leave	Enable the fast leave on the port.

After finished the above settings, click **Apply** to save the configuration. The settings will take effect.

## 2.3.26 MVR - Group Information

### Function name:

MVR - Group Information

### Function description:

The function is to display the MVR Groups detail information on the switch. Entries in the MVR Group Table are shown on this page. The MVR Group Table is sorted first by VLAN ID, and then by group.

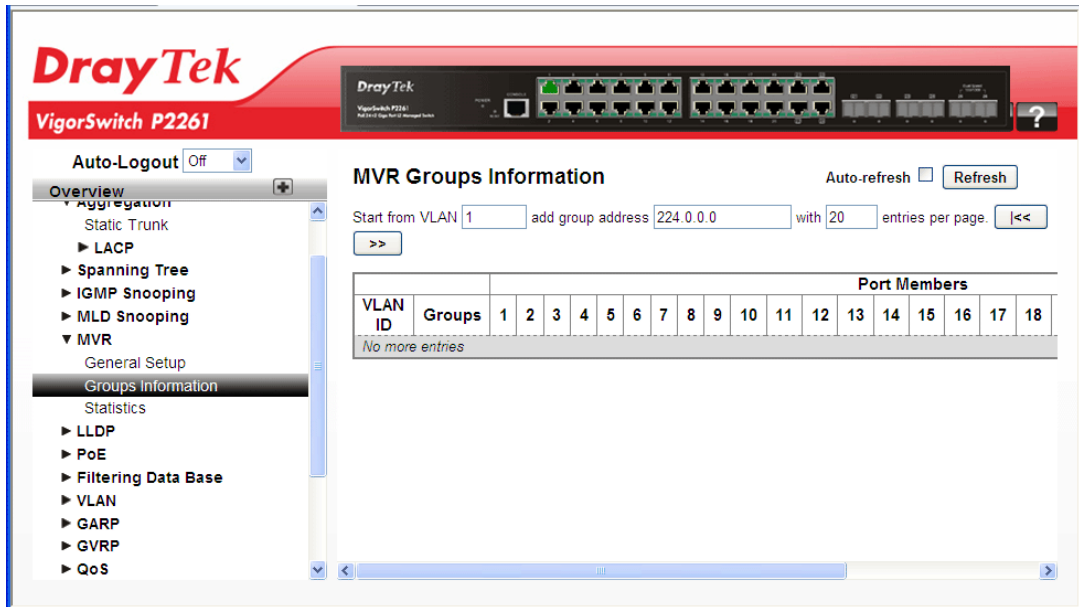

### Parameters description:

VLAN ID	VLAN ID of the group.
Groups	Group ID of the group displayed.
Port Members	Ports under this group.
Auto refresh	The simple counts will be refreshed automatically on the UI screen.
Refresh	The simple counts will be refreshed manually when user use mouse to click on “Refresh” button.

## 2.3.27 MVR – Statistics

**Function name:**

MVR – Statistics

**Function description:**

The function is used to display the MVR detail Statistics after you had configured MVR on the switch. It provides the detail MVR Statistics Information.

The screenshot shows the DrayTek web interface for a VigorSwitch P2261. The 'MVR Statistics' page is active, displaying a table with the following data:

VLAN ID	V1 Reports Received	V2 Reports Received	V3 Reports Received	V2 Leaves Received
100	0	0	0	0

Additional UI elements include an 'Auto-Logout' dropdown set to 'Off', an 'Overview' menu on the left, and 'Auto-refresh', 'Refresh', and 'Clear' buttons at the top right of the statistics section.

**Parameters description:**

VLAN ID	The Multicast VLAN ID.
V1 Reports Received	The number of Received V1 Reports.
V2 Reports Received	The number of Received V2 Reports.
V3 Reports Received	The number of Received V3 Reports.
V2 Leaves Received	The number of Received V2 Leaves.
Auto refresh	The simple counts will be refreshed automatically on the UI screen.
Refresh	The simple counts will be refreshed manually when user use mouse to click on “Refresh” button.
Clear	The simple counts will be reset to zero when user use mouse to click on “Clear” button.

## 2.3.28 LLDP – LLDP General Setup

The switch supports the LLDP. For current information on your switch model, The Link Layer Discovery Protocol (LLDP) provides a standards-based method for enabling switches to advertise themselves to adjacent devices and to learn about adjacent LLDP devices. The Link Layer Discovery Protocol (LLDP) is a vendor-neutral Link Layer protocol in the Internet Protocol Suite used by network devices for advertising their identity, capabilities, and neighbors on a IEEE 802 local area network, principally wired Ethernet. The protocol is formally referred to by the IEEE as Station and Media Access Control Connectivity Discovery specified in standards document IEEE 802.1AB.

### Function name:

LLDP – LLDP General Setup

### Function description:

The function is used to inspect and configure the current LLDP port settings.

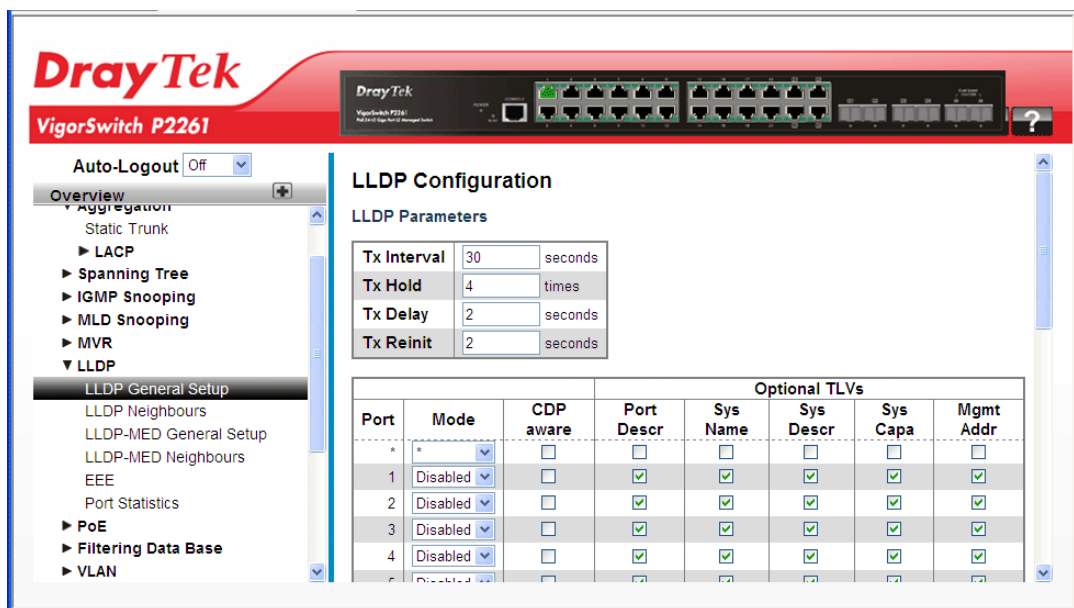

### Parameters description:

Tx Interval	The switch periodically transmits LLDP frames to its neighbours for having the network discovery information up-to-date. The interval between each LLDP frame is determined by the Tx Interval value. Valid values are restricted to 5 - 32768 seconds.
Tx Hold	Each LLDP frame contains information about how long the information in the LLDP frame shall be considered valid. The LLDP information valid period is set to Tx Hold multiplied by Tx Interval seconds. Valid values are restricted to 2 - 10 times.
Tx Delay	If some configuration is changed (e.g. the IP address) a new LLDP frame is transmitted, but the time between the LLDP frames will always be at least the value of Tx Delay seconds. Tx Delay cannot be larger than 1/4 of the Tx Interval value. Valid values are restricted to 1 - 8192 seconds.
Tx Reinit	When a port is disabled, LLDP is disabled or the switch is

	rebooted, an LLDP shutdown frame is transmitted to the neighboring units, signaling that the LLDP information isn't valid anymore. Tx Reinit controls the amount of seconds between the shutdown frame and a new LLDP initialization. Valid values are restricted to 1 - 10 seconds.
Port	The switch port number of the logical LLDP port.
Mode	<p>Select LLDP mode.</p> <p>Rx only The switch will not send out LLDP information, but LLDP information from neighbour units is analyzed.</p> <p>Tx only The switch will drop LLDP information received from neighbours, but will send out LLDP information.</p> <p>Disabled The switch will not send out LLDP information, and will drop LLDP information received from neighbours.</p> <p>Enabled The switch will send out LLDP information, and will analyze LLDP information received from neighbours.</p>
CDP Aware	<p>Select CDP awareness.</p> <p>The CDP operation is restricted to decoding incoming CDP frames (The switch doesn't transmit CDP frames). CDP frames are only decoded if LLDP on the port is enabled.</p> <p>Only CDP TLVs that can be mapped to a corresponding field in the LLDP neighbours' table are decoded. All other TLVs are discarded (Unrecognized CDP TLVs and discarded CDP frames are not shown in the LLDP statistics.). CDP TLVs are mapped onto LLDP neighbours' table as shown below.</p> <p>CDP TLV "Device ID" is mapped to the LLDP "Chassis ID" field.</p> <p>CDP TLV "Address" is mapped to the LLDP "Management Address" field. The CDP address TLV can contain multiple addresses, but only the first address is shown in the LLDP neighbours' table.</p> <p>CDP TLV "Port ID" is mapped to the LLDP "Port ID" field.</p> <p>CDP TLV "Version and Platform" is mapped to the LLDP "System Description" field.</p> <p>Both the CDP and LLDP support "system capabilities", but the CDP capabilities cover capabilities that are not part of the LLDP. These capabilities are shown as "others" in the LLDP neighbours' table.</p> <p>If all ports have CDP awareness disabled the switch forwards CDP frames received from neighbour devices. If at least one port has CDP awareness enabled all CDP frames are terminated by the switch.</p> <p><b>Note:</b> When CDP awareness on a port is disabled the CDP information isn't removed immediately, but gets when the hold time is exceeded.</p>
Port Descr	Optional TLV: When checked the "port description" is included in LLDP information transmitted.
Sys Name	Optional TLV: When checked the "system name" is included in LLDP information transmitted.



Sys Descr	Optional TLV: When checked the "system description" is included in LLDP information transmitted.
Sys Capa	Optional TLV: When checked the "system capability" is included in LLDP information transmitted.
Mgmt Addr	Optional TLV: When checked the "management address" is included in LLDP information transmitted.

After finished the above settings, click **Apply** to save the configuration. The settings will take effect.

### 2.3.29 LLDP – LLDP Neighbours

**Function name:**

LLDP – LLDP Neighbours

**Function description:**

The function is used to display a status overview for all LLDP neighbours. The displayed table contains a row for each port on which an LLDP neighbour is detected. The columns hold the following information:

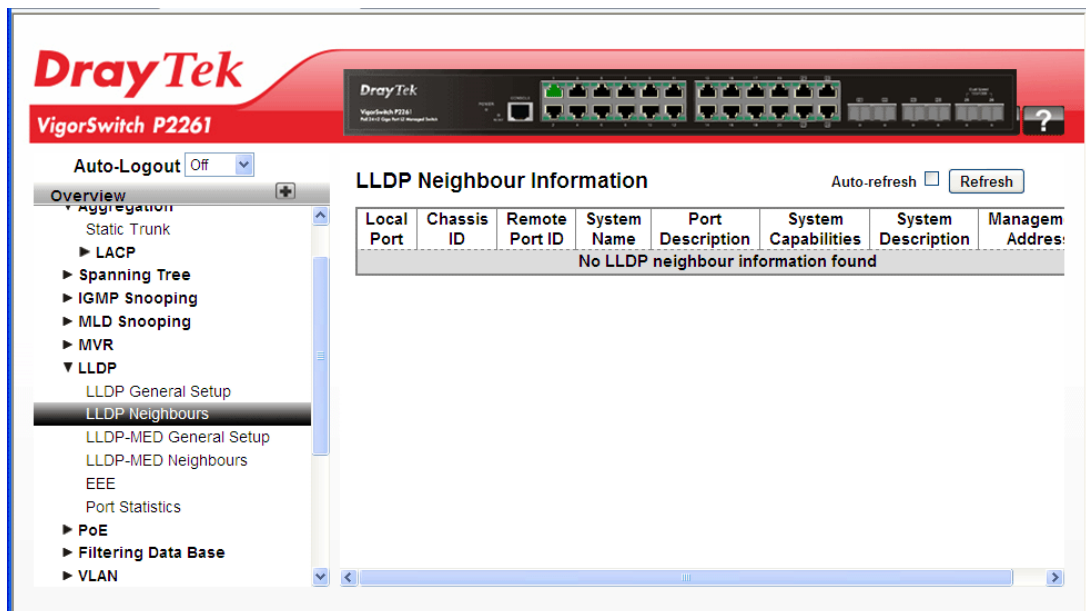

**Parameters description:**

Local Port	The port on which the LLDP frame was received.
Chassis ID	The Chassis ID is the identification of the neighbour's LLDP frames.
Remote Port ID	The Remote Port ID is the identification of the neighbour port.
System Name	System Name is the name advertised by the neighbour unit.
Port Description	Port Description is the port description advertised by the neighbour unit.
System Capabilities	System Capabilities describes the neighbour unit's capabilities. The possible capabilities are: 1. Other

	2. Repeater 3. Bridge 4. WLAN Access Point 5. Router 6. Telephone 7. DOCSIS cable device 8. Station only 9. Reserved When a capability is enabled, the capability is followed by (+). If the capability is disabled, the capability is followed by (-).
Management Address	Management Address is the neighbour unit's address that is used for higher layer entities to assist discovery by the network management. This could for instance hold the neighbour's IP address.
Auto refresh	The simple counts will be refreshed automatically on the UI screen.
Refresh	The simple counts will be refreshed manually when user use mouse to click on "Refresh" button.

After finished the above settings, click **Apply** to save the configuration. The settings will take effect.

### 2.3.30 LLDP – LLDP-MED General Setup

Media Endpoint Discovery is an enhancement of LLDP, known as LLDP-MED, that provides the following facilities:

Auto-discovery of LAN policies (such as VLAN, Layer 2 Priority and Differentiated services (Diffserv) settings) enabling plug and play networking.

Device location discovery to allow creation of location databases and, in the case of Voice over Internet Protocol (VoIP), Enhanced 911 services.

Extended and automated power management of Power over Ethernet (PoE) end points.

Inventory management, allowing network administrators to track their network devices, and determine their characteristics (manufacturer, software and hardware versions, serial or asset number).

**Function name:**

LLDP – LLDP-MED General Setup

**Function description:**

The function is used to configure the LLDP-MED. This function applies to VoIP devices which support LLDP-MED.

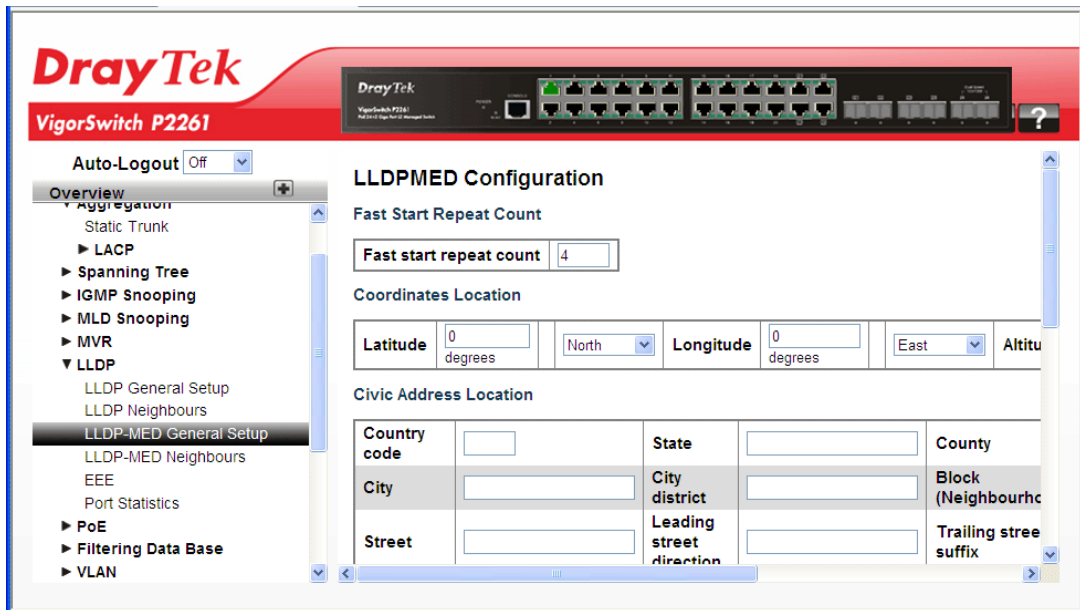

### Parameters description:

#### Fast start repeat count

Fast start repeat count

Rapid startup and Emergency Call Service Location Identification Discovery of endpoints is a critically important aspect of VoIP systems in general. In addition, it is best to advertise only those pieces of information which are specifically relevant to particular endpoint types (for example only advertise the voice network policy to permitted voice-capable devices), both in order to conserve the limited LLDPDU space and to reduce security and system integrity issues that can come with inappropriate knowledge of the network policy.

With this in mind LLDP-MED defines an LLDP-MED Fast Start interaction between the protocol and the application layers on top of the protocol, in order to achieve these related properties. Initially, a Network Connectivity Device will only transmit LLDP TLVs in an LLDPDU. Only after an LLDP-MED Endpoint Device is detected, will an LLDP-MED capable Network Connectivity Device start to advertise LLDP-MED TLVs in outgoing LLDPDUs on the associated port. The LLDP-MED application will temporarily speed up the transmission of the LLDPDU to start within a second, when a new LLDP-MED neighbour has been detected in order share LLDP-MED information as fast as possible to new neighbours.

Because there is a risk of an LLDP frame being lost during transmission between neighbours, it is recommended to repeat the fast start transmission multiple times to increase the possibility of the neighbours receiving the LLDP frame. With Fast start repeat count it is possible to specify the number of times the fast start transmission would be repeated. The recommended value is 4 times, given that 4 LLDP frames with a 1 second interval will be transmitted, when an LLDP frame with new information is received.

	It should be noted that LLDP-MED and the LLDP-MED Fast Start mechanism is only intended to run on links between LLDP-MED Network Connectivity Devices and Endpoint Devices, and as such does not apply to links between LAN infrastructure elements, including Network Connectivity Devices, or other types of links.
Coordinates Location	
Latitude	Latitude SHOULD be normalized to within 0-90 degrees with a maximum of 4 digits. It is possible to specify the direction to either North of the equator or South of the equator.
Longitude	Longitude SHOULD be normalized to within 0-180 degrees with a maximum of 4 digits. It is possible to specify the direction to either East of the prime meridian or West of the prime meridian.
Altitude	Altitude SHOULD be normalized to within -32767 to 32767 with a maximum of 4 digits. It is possible to select between two altitude types (floors or meters). Meters: Representing meters of Altitude defined by the vertical datum specified. Floors: Representing altitude in a form more relevant in buildings which have different floor-to-floor dimensions. An altitude = 0.0 is meaningful even outside a building, and represents ground level at the given latitude and longitude. Inside a building, 0.0 represents the floor level associated with ground level at the main entrance.
Map Datum	The Map Datum is used for the coordinates given in these options: WGS84: (Geographical 3D) - World Geodesic System 1984, CRS Code 4327, Prime Meridian Name: Greenwich. NAD83/NAVD88: North American Datum 1983, CRS Code 4269, Prime Meridian Name: Greenwich; The associated vertical datum is the North American Vertical Datum of 1988 (NAVD88). This datum pair is to be used when referencing locations on land, not near tidal water (which would use Datum = NAD83/MLLW). NAD83/MLLW: North American Datum 1983, CRS Code 4269, Prime Meridian Name: Greenwich; The associated vertical datum is Mean Lower Low Water (MLLW). This datum pair is to be used when referencing locations on water/sea/ocean.
Civic Address Location	
IETF Geopriv Civic Address based Location Configuration Information (Civic Address LCI).	
Country code	The two-letter ISO 3166 country code in capital ASCII letters - Example: DK, DE or US.
State	National subdivisions (state, canton, region, province,

	prefecture).
County	County, parish, gun (Japan), district.
City	City, township, shi (Japan) - Example: Copenhagen.
City district	City division, borough, city district, ward, chou (Japan).
Block (Neighbourhood)	Neighbourhood, block.
Street	Street - Example: Poppelvej.
Leading street direction	Leading street direction - Example: N.
Trailing street suffix	Trailing street suffix - Example: SW.
Street suffix	Street suffix - Example: Ave, Platz.
House no.	House number - Example: 21.
House no. suffix	House number suffix - Example: A, 1/2.
Landmark	Landmark or vanity address - Example: Columbia University.
Additional location info	Additional location info - Example: South Wing.
Name	Name (residence and office occupant) - Example: Flemming Jahn.
Zip code	Postal/zip code - Example: 2791.
Building	Building (structure) - Example: Low Library.
Apartment	Unit (Apartment, suite) - Example: Apt 42.
Floor	Floor - Example: 4.
Room no.	Room number - Example: 450F.
Place type	Place type - Example: Office.
Postal community name	Postal community name - Example: Leonia.
P.O. Box	Post office box (P.O. BOX) - Example: 12345.
Additional code	Additional code - Example: 1320300003.
Emergency Call Service	
Emergency Call Service (e.g. E911 and others), such as defined by TIA or NENA.	
Emergency Call Service	Emergency Call Service ELIN identifier data format is defined to carry the ELIN identifier as used during emergency call setup to a traditional CAMA or ISDN trunk-based PSAP. This format consists of a numerical digit string, corresponding to the ELIN to be used for emergency calling.
Policies	
Network Policy Discovery enables the efficient discovery and diagnosis of mismatch issues with the VLAN configuration, along with the associated Layer 2 and Layer 3 attributes, which apply for a set of specific protocol applications on that port. Improper network policy configurations are a very significant issue in VoIP	

environments that frequently result in voice quality degradation or loss of service.

Policies are only intended for use with applications that have specific 'real-time' network policy requirements, such as interactive voice and/or video services.

The network policy attributes advertised are:

1. Layer 2 VLAN ID (IEEE 802.1Q-2003)
2. Layer 2 priority value (IEEE 802.1D-2004)
3. Layer 3 Diffserv code point (DSCP) value (IETF RFC 2474)

This network policy is potentially advertised and associated with multiple sets of application types supported on a given port. The application types specifically addressed are:

1. Voice
2. Guest Voice
3. Softphone Voice
4. Video Conferencing
5. Streaming Video
6. Control / Signalling (conditionally support a separate network policy for the media types above)

A large network may support multiple VoIP policies across the entire organization, and different policies per application type. LLDP-MED allows multiple policies to be advertised per port, each corresponding to a different application type. Different ports on the same Network Connectivity Device may advertise different sets of policies, based on the authenticated user identity or port configuration.

It should be noted that LLDP-MED is not intended to run on links other than between Network Connectivity Devices and Endpoints, and therefore does not need to advertise the multitude of network policies that frequently run on an aggregated link interior to the LAN.

Delete	Click to delete the policy.
Policy ID	ID for the policy. This is auto generated and shall be used when selecting the police that shall be mapped to the specific ports.
Application Type	Intended use of the application types: <ol style="list-style-type: none"> <li>1. Voice - for use by dedicated IP Telephony handsets and other similar appliances supporting interactive voice services. These devices are typically deployed on a separate VLAN for ease of deployment and enhanced security by isolation from data applications.</li> <li>2. Voice Signaling (conditional) - for use in network topologies that require a different policy for the voice signaling than for the voice media. This application type should not be advertised if all the same network policies apply as those advertised in the Voice application policy.</li> </ol>

	<p>3. Guest Voice - support a separate 'limited feature-set' voice service for guest users and visitors with their own IP Telephony handsets and other similar appliances supporting interactive voice services.</p> <p>4. Guest Voice Signaling (conditional) - for use in network topologies that require a different policy for the guest voice signaling than for the guest voice media. This application type should not be advertised if all the same network policies apply as those advertised in the Guest Voice application policy.</p> <p>5. Softphone Voice - for use by softphone applications on typical data centric devices, such as PCs or laptops. This class of endpoints frequently does not support multiple VLANs, if at all, and are typically configured to use an 'untagged' VLAN or a single 'tagged' data specific VLAN. When a network policy is defined for use with an 'untagged' VLAN (see Tagged flag below), then the L2 priority field is ignored and only the DSCP value has relevance.</p> <p>6. Video Conferencing - for use by dedicated Video Conferencing equipment and other similar appliances supporting real-time interactive video/audio services.</p> <p>7. Streaming Video - for use by broadcast or multicast based video content distribution and other similar applications supporting streaming video services that require specific network policy treatment. Video applications relying on TCP with buffering would not be an intended use of this application type.</p> <p>8. Video Signaling (conditional) - for use in network topologies that require a separate policy for the video signaling than for the video media. This application type should not be advertised if all the same network policies apply as those advertised in the Video Conferencing application policy.</p>
Tag	<p>Tag indicating whether the specified application type is using a 'tagged' or an 'untagged' VLAN.</p> <p>Untagged indicates that the device is using an untagged frame format and as such does not include a tag header as defined by IEEE 802.1Q-2003. In this case, both the VLAN ID and the Layer 2 priority fields are ignored and only the DSCP value has relevance.</p> <p>Tagged indicates that the device is using the IEEE 802.1Q tagged frame format, and that both the VLAN ID and the Layer 2 priority values are being used, as well as the DSCP value. The tagged format includes an additional field, known as the tag header. The tagged frame format also includes priority tagged frames as defined by IEEE 802.1Q-2003.</p>
VLAN ID	VLAN identifier (VID) for the port as defined in IEEE 802.1Q-2003.
L2 Priority	L2 Priority is the Layer 2 priority to be used for the specified application type. L2 Priority may specify one of

	eight priority levels (0 through 7), as defined by IEEE 802.1D-2004. A value of 0 represents use of the default priority as defined in IEEE 802.1D-2004.
DSCP	DSCP value to be used to provide Diffserv node behaviour for the specified application type as defined in IETF RFC 2474. DSCP may contain one of 64 code point values (0 through 63). A value of 0 represents use of the default DSCP value as defined in RFC 2475.
Adding a new policy	Click to add a new policy. Specify the Application type, Tag, VLAN ID, L2 Priority and DSCP for the new policy. Click "Apply".
<b>Port Policies Configuration</b>	
Every port may advertise a unique set of network policies or different attributes for the same network policies, based on the authenticated user identity or port configuration.	
Port	The port number to which the configuration applies.
Policy ID	The set of policies that shall apply to a given port. The set of policies is selected by check marking the checkboxes that corresponds to the policies.

After finished the above settings, click **Apply** to save the configuration. The settings will take effect.



### 2.3.31 LLDP – LLDP-MED Neighbours

This page provides a status overview of all LLDP-MED neighbours. The displayed table contains a row for each port on which an LLDP neighbour is detected.

**Function name:**

LLDP – LLDP-MED Neighbours

**Function description:**

This function applies to VoIP devices which support LLDP-MED.

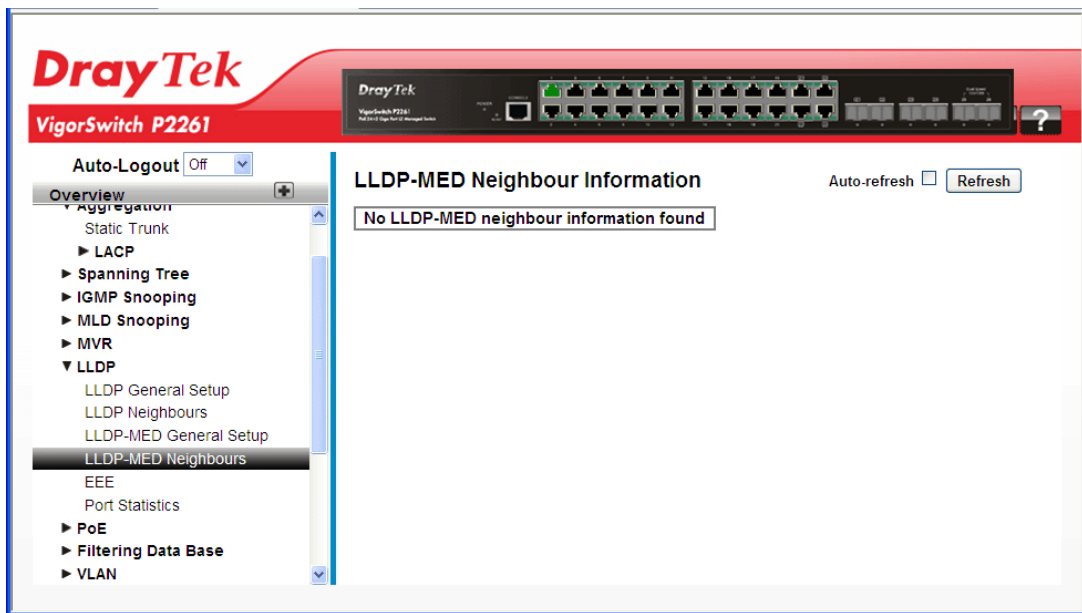

**Parameters description:**

Port	The port on which the LLDP frame was received.
Device Type	<p>LLDP-MED Devices are comprised of two primary Device Types: Network Connectivity Devices and Endpoint Devices.</p> <p>LLDP-MED Network Connectivity Device Definition</p> <p>LLDP-MED Network Connectivity Devices, as defined in TIA-1057, provide access to the IEEE 802 based LAN infrastructure for LLDP-MED Endpoint Devices. An LLDP-MED Network Connectivity Device is a LAN access device based on any of the following technologies:</p> <ol style="list-style-type: none"> <li>1. LAN Switch/Router</li> <li>2. IEEE 802.1 Bridge</li> <li>3. IEEE 802.3 Repeater (included for historical reasons)</li> <li>4. IEEE 802.11 Wireless Access Point</li> <li>5. Any device that supports the IEEE 802.1AB and MED extensions defined by TIA-1057 and can relay IEEE 802 frames via any method.</li> </ol>
LLDP-MED Endpoint Device Definition	LLDP-MED Endpoint Devices, as defined in TIA-1057, are located at the IEEE 802 LAN network edge, and participate in IP communication service using the LLDP-MED

	<p>framework.</p> <p>Within the LLDP-MED Endpoint Device category, the LLDP-MED scheme is broken into further Endpoint Device Classes, as defined in the following.</p> <p>Each LLDP-MED Endpoint Device Class is defined to build upon the capabilities defined for the previous Endpoint Device Class. For-example will any LLDP-MED Endpoint Device claiming compliance as a Media Endpoint (Class II) also support all aspects of TIA-1057 applicable to Generic Endpoints (Class I), and any LLDP-MED Endpoint Device claiming compliance as a Communication Device (Class III) will also support all aspects of TIA-1057 applicable to both Media Endpoints (Class II) and Generic Endpoints (Class I).</p>
<p>LLDP-MED Generic Endpoint (Class I)</p>	<p>The LLDP-MED Generic Endpoint (Class I) definition is applicable to all endpoint products that require the base LLDP discovery services defined in TIA-1057, however do not support IP media or act as an end-user communication appliance. Such devices may include (but are not limited to) IP Communication Controllers, other communication related servers, or any device requiring basic services as defined in TIA-1057.</p> <p>Discovery services defined in this class include LAN configuration, device location, network policy, power management, and inventory management.</p>
<p>LLDP-MED Media Endpoint (Class II)</p>	<p>The LLDP-MED Media Endpoint (Class II) definition is applicable to all endpoint products that have IP media capabilities however may or may not be associated with a particular end user. Capabilities include all of the capabilities defined for the previous Generic Endpoint Class (Class I), and are extended to include aspects related to media streaming. Example product categories expected to adhere to this class include (but are not limited to) Voice / Media Gateways, Conference Bridges, Media Servers, and similar.</p> <p>Discovery services defined in this class include media-type-specific network layer policy discovery.</p>
<p>LLDP-MED Communication Endpoint (Class III)</p>	<p>The LLDP-MED Communication Endpoint (Class III) definition is applicable to all endpoint products that act as end user communication appliances supporting IP media. Capabilities include all of the capabilities defined for the previous Generic Endpoint (Class I) and Media Endpoint (Class II) classes, and are extended to include aspects related to end user devices. Example product categories expected to adhere to this class include (but are not limited to) end user communication appliances, such as IP Phones, PC-based softphones, or other communication appliances that directly support the end user.</p> <p>Discovery services defined in this class include provision of location identifier (including ECS / E911 information), embedded L2 switch support, inventory management.</p>

LLDP-MED Capabilities	<p>LLDP-MED Capabilities describes the neighbour unit's LLDP-MED capabilities. The possible capabilities are:</p> <ol style="list-style-type: none"> <li>1. LLDP-MED capabilities</li> <li>2. Network Policy</li> <li>3. Location Identification</li> <li>4. Extended Power via MDI - PSE</li> <li>5. Extended Power via MDI - PD</li> <li>6. Inventory</li> <li>7. Reserved</li> </ol>
Application Type	<p>Application Type indicating the primary function of the application(s) defined for this network policy, advertised by an Endpoint or Network Connectivity Device. The possible application types are shown below.</p> <ol style="list-style-type: none"> <li>1. Voice - for use by dedicated IP Telephony handsets and other similar appliances supporting interactive voice services. These devices are typically deployed on a separate VLAN for ease of deployment and enhanced security by isolation from data applications.</li> <li>2. Voice Signaling - for use in network topologies that require a different policy for the voice signaling than for the voice media.</li> <li>3. Guest Voice - to support a separate limited feature-set voice service for guest users and visitors with their own IP Telephony handsets and other similar appliances supporting interactive voice services.</li> <li>4. Guest Voice Signaling - for use in network topologies that require a different policy for the guest voice signaling than for the guest voice media.</li> <li>5. Softphone Voice - for use by softphone applications on typical data centric devices, such as PCs or laptops.</li> <li>6. Video Conferencing - for use by dedicated Video Conferencing equipment and other similar appliances supporting real-time interactive video/audio services.</li> <li>7. Streaming Video - for use by broadcast or multicast based video content distribution and other similar applications supporting streaming video services that require specific network policy treatment. Video applications relying on TCP with buffering would not be an intended use of this application type.</li> <li>8. Video Signaling - for use in network topologies that require a separate policy for the video signaling than for the video media.</li> </ol>
Policy	<p>Policy indicates that an Endpoint Device wants to explicitly advertise that the policy is required by the device. Can be either Defined or Unknown</p> <p>Unknown: The network policy for the specified application</p>

	<p>type is currently unknown.</p> <p>Defined: The network policy is defined.</p>
TAG	<p>TAG is indicative of whether the specified application type is using a tagged or an untagged VLAN. Can be Tagged or Untagged.</p> <p>Untagged: The device is using an untagged frame format and as such does not include a tag header as defined by IEEE 802.1Q-2003.</p> <p>Tagged: The device is using the IEEE 802.1Q tagged frame format.</p>
VLAN ID	<p>VLAN ID is the VLAN identifier (VID) for the port as defined in IEEE 802.1Q-2003. A value of 1 through 4094 is used to define a valid VLAN ID. A value of 0 (Priority Tagged) is used if the device is using priority tagged frames as defined by IEEE 802.1Q-2003, meaning that only the IEEE 802.1D priority level is significant and the default PVID of the ingress port is used instead.</p>
Priority	<p>Priority is the Layer 2 priority to be used for the specified application type. One of the eight priority levels (0 through 7).</p>
DSCP	<p>DSCP is the DSCP value to be used to provide Diffserv node behavior for the specified application type as defined in IETF RFC 2474. Contain one of 64 code point values (0 through 63).</p>
Auto refresh	<p>The simple counts will be refreshed automatically on the UI screen.</p>
Refresh	<p>The simple counts will be refreshed manually when user use mouse to click on “Refresh” button.</p>

### 2.3.32 LLDP – EEE

By using EEE power savings can be achieved at the expense of traffic latency. This latency occurs due to that the circuits EEE turn off to save power, need time to boot up before sending traffic over the link. This time is called "wake up time". To achieve minimal latency, devices can use LLDP to exchange information about their respective tx and rx "wake up time", as a way to agree upon the minimum wake up time they need.

**Function name:**

Aggregation – Static Trunk

**Function description:**

The function is used to provide an overview of EEE information exchanged by LLDP.

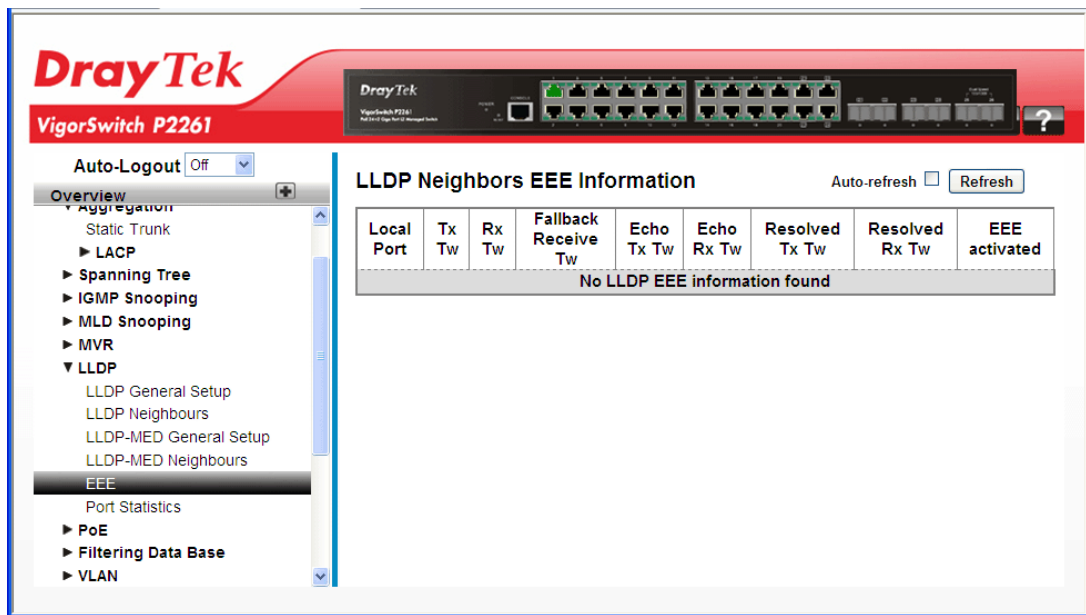

**Parameters description:**

Local Port	The port on which LLDP frames are received or transmitted.
Tx Tw	The link partner's maximum time that transmit path can hold-off sending data after deassertion of LPI.
Rx Tw	The link partner's time that receiver would like the transmitter to hold-off to allow time for the receiver to wake from sleep.
Fallback Receive Tw	The link partner's fallback receive Tw. A receiving link partner may inform the transmitter of an alternate desired Tw_sys_tx. Since a receiving link partner is likely to have discrete levels for savings, this provides the transmitter with additional information that it may use for a more efficient allocation. Systems that do not implement this option default the value to be the same as that of the Receive Tw_sys_tx.
Echo Tx Tw	The link partner's Echo Tx Tw value. The respective echo values shall be defined as the local link partner reflection (echo) of the remote link partners respective values. When a local link partner receives its

	<p>echoed values from the remote link partner it can determine whether or not the remote link partner has received, registered and processed its most recent values. For example, if the local link partner receives echoed parameters that do not match the values in its local MIB, then the local link partner infers that the remote link partners request was based on stale information.</p>
Echo Rx Tw	The link partner's Echo Rx Tw value.
Resolved Tx Tw	<p>The resolved Tx Tw for this link. Note : NOT the link partner</p> <p>The resolved value that is the actual "tx wakeup time "used for this link (based on EEE information exchanged via LLDP).</p>
Resolved Rx Tw	<p>The resolved Rx Tw for this link. Note : NOT the link partner</p> <p>The resolved value that is the actual "tx wakeup time" used for this link (based on EEE information exchanged via LLDP).</p>
Auto refresh	The simple counts will be refreshed automatically on the UI screen.
Refresh	The simple counts will be refreshed manually when user use mouse to click on “Refresh” button.

### 2.3.33 LLDP – Port Statistics

**Function name:**

LLDP – Port Statistics

**Function description:**

Two types of counters are shown. Global counters are counters that refer to the whole stack, switch, while local counters refer to per port counters for the currently selected switch.

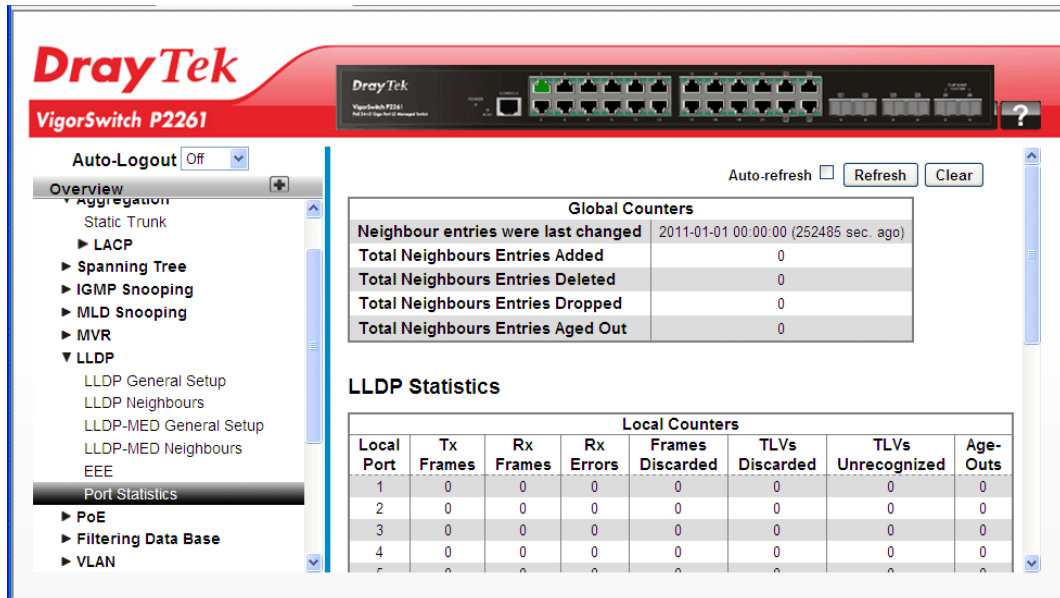

**Parameters description:**

Global Counters	
Neighbour entries were last changed on	It also shows the time when the last entry was last deleted or added. It also shows the time elapsed since the last change was detected.
Total Neighbours Entries Added	Shows the number of new entries added since switch reboot.
Total Neighbours Entries Deleted	Shows the number of new entries deleted since switch reboot.
Total Neighbours Entries Dropped	Shows the number of LLDP frames dropped due to the entry table being full.
Total Neighbours Entries Aged Out	Shows the number of entries deleted due to Time-To-Live expiring.
LLDP Statistics	
Local Port	The port on which LLDP frames are received or transmitted.
Tx Frames	The number of LLDP frames transmitted on the port.
Rx Frames	The number of LLDP frames received on the port.
Rx Errors	The number of received LLDP frames containing some kind of error.
Frames Discarded	If an LLDP frame is received on a port, and the switch's

	internal table has run full, the LLDP frame is counted and discarded. This situation is known as "Too Many Neighbours" in the LLDP standard. LLDP frames require a new entry in the table when the Chassis ID or Remote Port ID is not already contained within the table. Entries are removed from the table when a given port's link is down, an LLDP shutdown frame is received, or when the entry ages out.
TLVs Discarded	Each LLDP frame can contain multiple pieces of information, known as TLVs (TLV is short for "Type Length Value"). If a TLV is malformed, it is counted and discarded.
TLVs Unrecognized	The number of well-formed TLVs, but with an unknown type value.
Org. Discarded	The number of organizationally received TLVs.
Age-Outs	Each LLDP frame contains information about how long time the LLDP information is valid (age-out time). If no new LLDP frame is received within the age out time, the LLDP information is removed, and the Age-Out counter is incremented.
Auto refresh	The simple counts will be refreshed automatically on the UI screen.
Refresh	The simple counts will be refreshed manually when user use mouse to click on "Refresh" button.
Clear	The simple counts will be reset to zero when user use mouse to click on "Clear" button.

### 2.3.34 PoE – General Setup

**Function name:**

PoE – General Setup

**Function description:**

Power Over Ethernet is used to transmit electrical power, to remote devices over standard Ethernet cable. It could for example be used for powering IP telephones, wireless LAN access points and other equipment, where it would be difficult or expensive to connect the equipment to main power supply.

This page allows the user to inspect and configure the current PoE port settings and show all PoE Supply W.



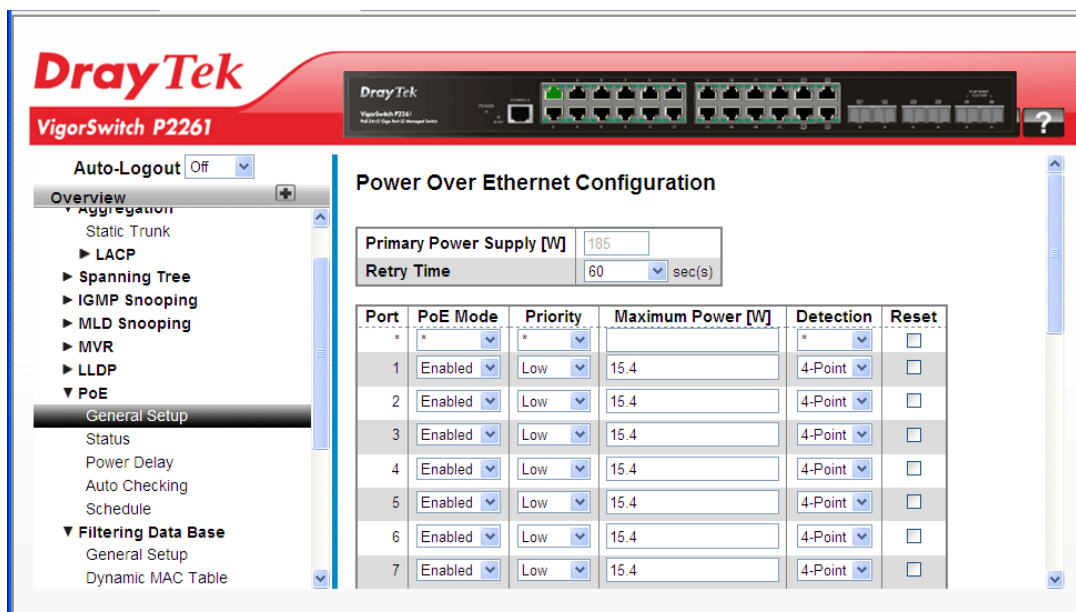

### Parameters description:

Primary Power Supply [W]	The switch can have PoE power supplies. It is used as power source, For being able to determine the amount of power the PD may use, it must be defined what amount of power the power sources can deliver.
Port	This is the logical port number for this row.
PoE State	The PoE Mode represents the PoE operating mode for the port. <b>Disabled:</b> PoE disabled for the port. <b>Enabled :</b> Enables PoE IEEE 802.3af/at.
Priority	The Priority represents the ports priority. There are three levels of power priority named Low, High and Critical. The priority is used in the case where the remote devices requires more power than the power supply can deliver. In this case the port with the lowest priority will be turn off starting from the port with the highest port number.
Maximum Power	The Maximum Power value contains a numerical value that indicates the maximum power in watts that can be delivered to a remote device. <b>NOTE:</b> If you want to set the Port support IEEE802.3at then you can set the Maximum allowed value is 30W.
Detection	Allows you to choose power supply mode ( <b>Legacy</b> and <b>4-Point</b> ).
Reset	Rest the PoE status.

### 2.3.35 PoE – Status

#### Function name:

PoE –Status

### Function description:

This page allows the user to inspect the current status for all PoE ports. The section shows all port Power Over Ethernet Status.

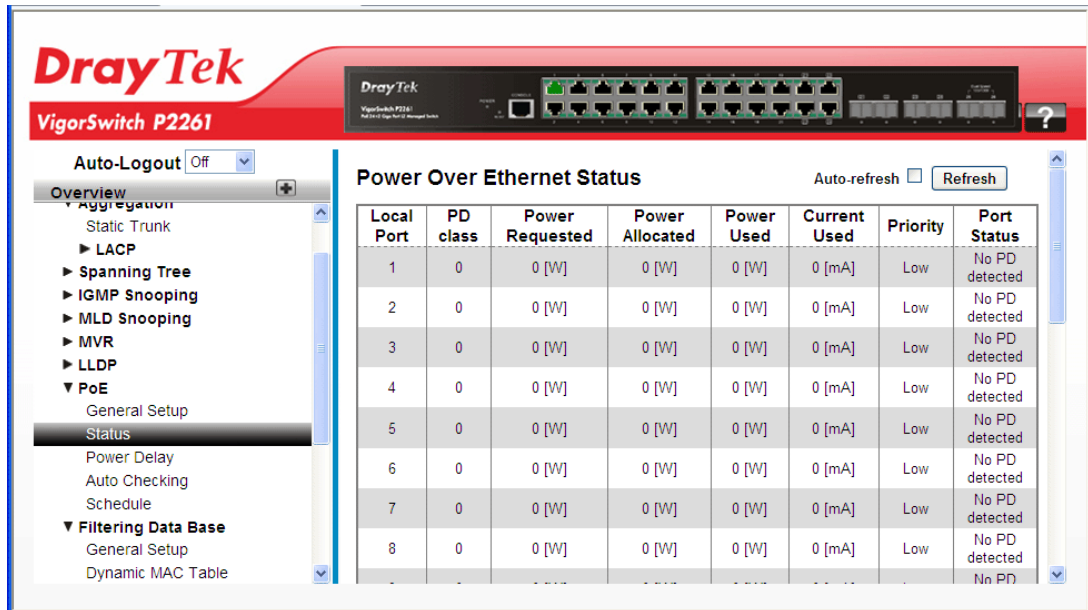

### Parameters description:

Local Port	This is the logical port number for this row.
PD Class	To display the PD Power class that identifies with a specified current. The classification current describes the amount of power the PD will require during normal operation.
Power Requested	The Power Requested shows the requested amount of power the PD wants to be reserved.
Power Allocated	The Power Allocated shows the amount of power the switch has allocated for the PD.
Power Used	The Power Used shows how much power the PD currently is using.
Current Used	The Power Used shows how much current the PD currently is using.
Priority	The Priority shows the port's priority configured by the user.
Port Status	The Port Status shows the port's status.
Auto refresh	The simple counts will be refreshed automatically on the UI screen.
Refresh	The simple counts will be refreshed manually when the user uses the mouse to click on the "Refresh" button.

## 2.3.36 PoE – Power Delay

### Function name:

PoE – Power Delay

### Function description:

Set the delay time for PoE power supply.

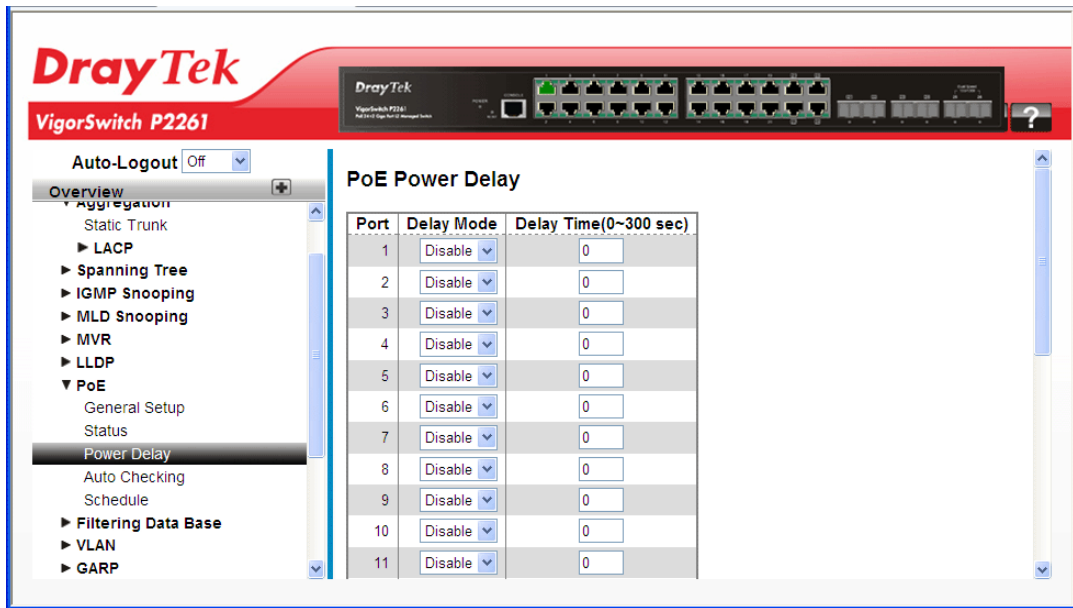

**Parameters description:**

Delay Mode	Enable/Disable this function.
Delay Time (0-300 sec)	Set the delay time for power mode.

**2.3.37 PoE – Auto Checking**

Function name:

PoE – Auto Checking

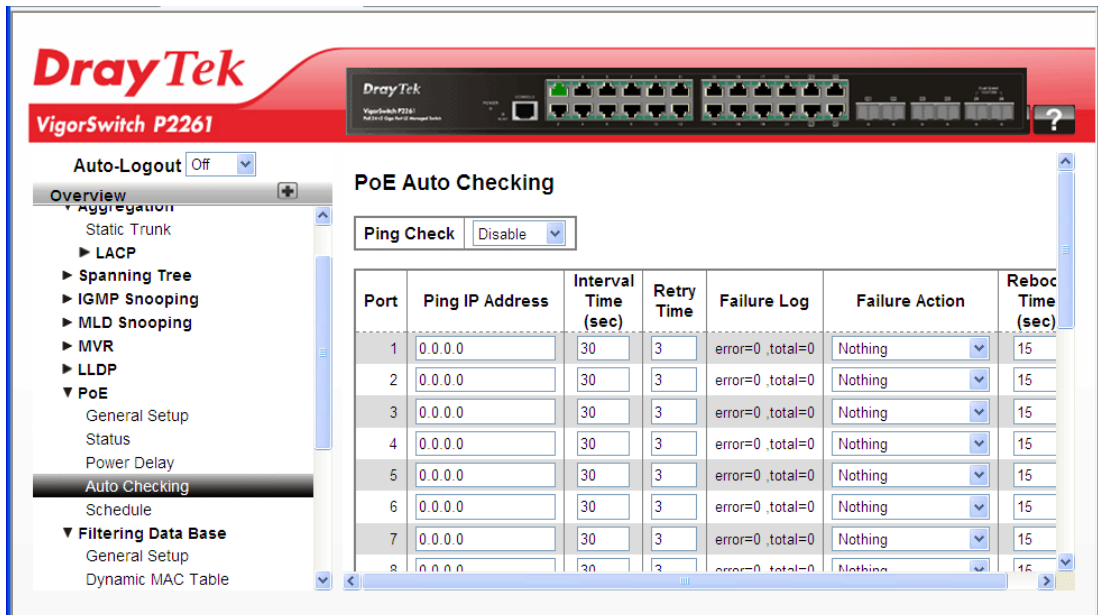

**Parameters description:**

Ping Check	Check the device with PING command.
Ping IP Address	Type the IP address of the device.

Interval Time (sec)	Set the time interval for PING command.
Retry Time	Set the retry time for performing the PING command.
Failure Log	Log the failure status.
Failure Action	Select the action for device failure.
Reboot Tim (sec)	Set the time to reboot the device.

### 2.3.38 PoE – Schedule

**Function name:**

PoE –Schedule

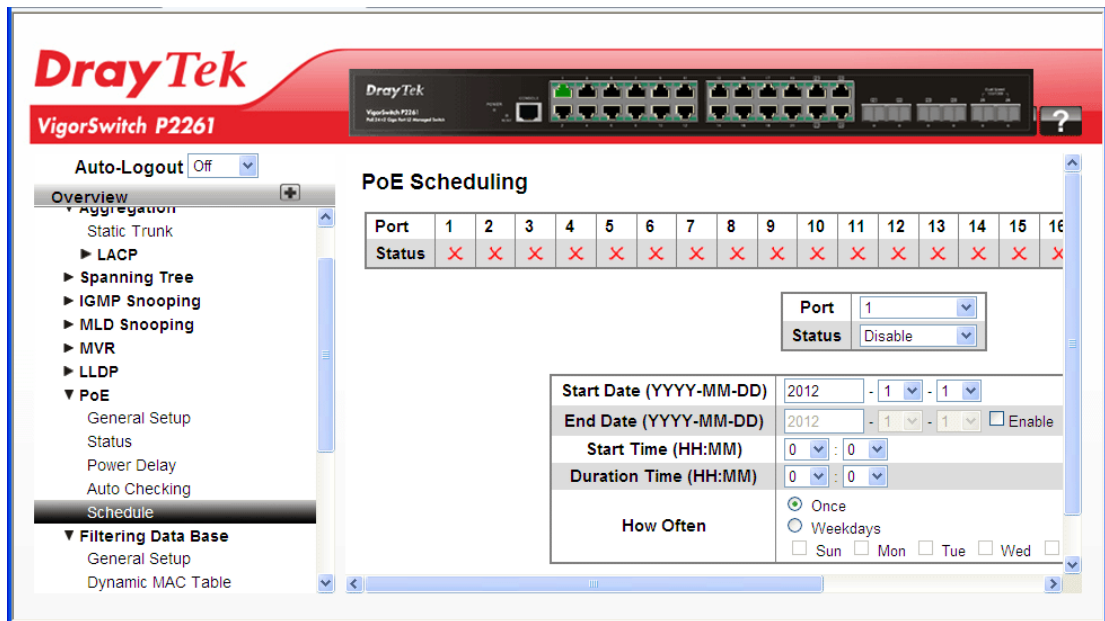

**Parameters description:**

Port	Specify the Port number to apply such function.
Status	Enable / Disable this function.
Start Date	Set the starting date for such schedule profile.
End Date	Set the ending date for such schedule profile.
Start Time	Set the starting time for such schedule profile.
Duration Time	Set the duration time for such schedule profile.
How Often	Specify the frequency of the schedule profile.

### 2.3.39 Filtering Data Base – General Setup

Filtering Data Base gathers many functions, including MAC Table Information, Static MAC Learning, which cannot be categorized to some function type.

Switching of frames is based upon the DMAC address contained in the frame. The switch builds up a table that maps MAC addresses to switch ports for knowing which ports the frames should go to (based upon the DMAC address in the frame). This table contains both

static and dynamic entries. The static entries are configured by the network administrator if the administrator wants to do a fixed mapping between the DMAC address and switch ports.

The frames also contain a MAC address (SMAC address), which shows the MAC address of the equipment sending the frame. The SMAC address is used by the switch to automatically update the MAC table with these dynamic MAC addresses. Dynamic entries are removed from the MAC table if no frame with the corresponding SMAC address has been seen after a configurable age time.

**Function name:**

Filtering Data Base – General Setup

**Function description:**

The MAC Address Table is configured on this page. Set timeouts for entries in the dynamic MAC Table and configure the static MAC table here.

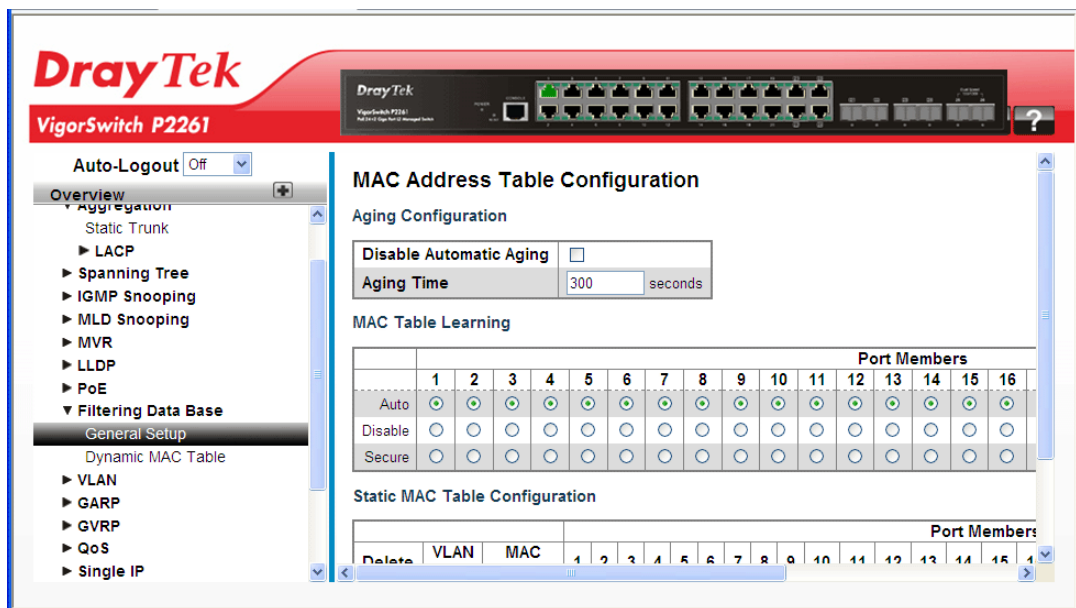

**Parameters description:**

Aging Configuration	
Disable Automatic Aging	Check it to enable this function.
Aging Time	By default, dynamic entries are removed from the MAC table after 300 seconds. This removal is also called aging. Configure aging time by entering a value here in seconds; for example, Age time seconds. The allowed range is 10 to 1000000 seconds. Disable the automatic aging of dynamic entries by checking the box of Disable automatic aging.
MAC Table Learning	
Auto	Learning is done automatically as soon as a frame with unknown SMAC is received. If the learning mode for a given port is greyed out and another module is in control of the mode, it cannot be changed by the user. An example of such a module is the

	MAC-Based Authentication under 802.1X.
Disable	No learning is done.
Secure	Only static MAC entries are learned, all other frames are dropped. <b>Note:</b> Make sure that the link used for managing the switch is added to the Static Mac Table before changing to secure learning mode, otherwise the management link is lost and can only be restored by using another non-secure port or by connecting to the switch via the serial interface.
Static MAC Table Configuration	
Delete	Click to delete the entry.
VLAN ID	The VLAN ID of the entry.
MAC Address	The MAC address of the entry.
Port Members	Checkmarks indicate which ports are members of the entry. Check or uncheck as needed to modify the entry.
Adding a New Static Entry	Click to add a new entry to the static MAC table. Specify the VLAN ID, MAC address, and port members for the new entry. Click "Apply".

After finished the above settings, click **Apply** to save the configuration. The settings will take effect.

### 2.3.40 Filtering Data Base – Dynamic MAC Table

**Function name:**

Filtering Data Base – Dynamic MAC Table

**Function description:**

Entries in the MAC Table are shown on this page. The MAC Table contains up to 8192 entries, and is sorted first by VLAN ID, then by MAC address.

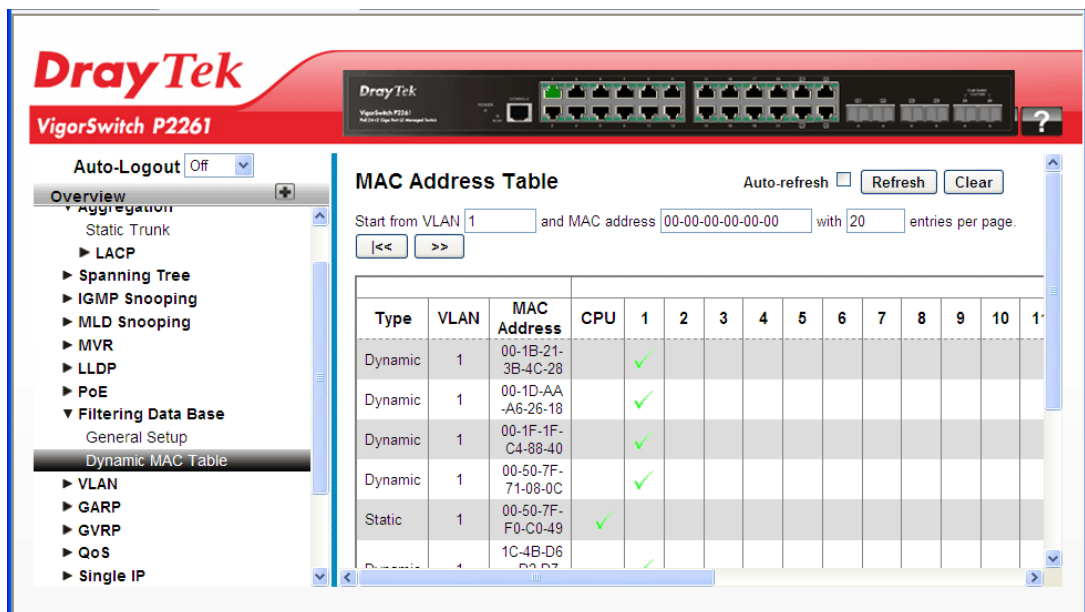

**Parameters description:**

Type	Indicates whether the entry is a static or a dynamic entry.
MAC address	The MAC address of the entry.
VLAN	The VLAN ID of the entry.
Port Members	The ports that are members of the entry.
Auto refresh	The simple counts will be refreshed automatically on the UI screen.
Refresh	The simple counts will be refreshed manually when user use mouse to click on “Refresh” button.
Clear	The simple counts will be reset to zero when user use mouse to click on “Clear” button.

### 2.3.41 VLAN – VLAN Membership

To assign a specific VLAN for management purpose, the management VLAN is used to establish an IP connection to the switch from a workstation connected to a port in the VLAN. This connection supports a VSM, SNMP, and Telnet session. By default, the active management VLAN is VLAN 1, but you can designate any VLAN as the management VLAN using the Management VLAN window. Only one management VLAN can be active at a time.

When you specify a new management VLAN, your HTTP connection to the old management VLAN is lost. For this reason, you should have a connection between your management station and a port in the new management VLAN or connect to the new management VLAN through a multi-VLAN route.

**Function name:**

VLAN – VLAN Membership

**Function description:**

The function is used for adding and deleting VLANs as well as adding and deleting port members of each VLAN.

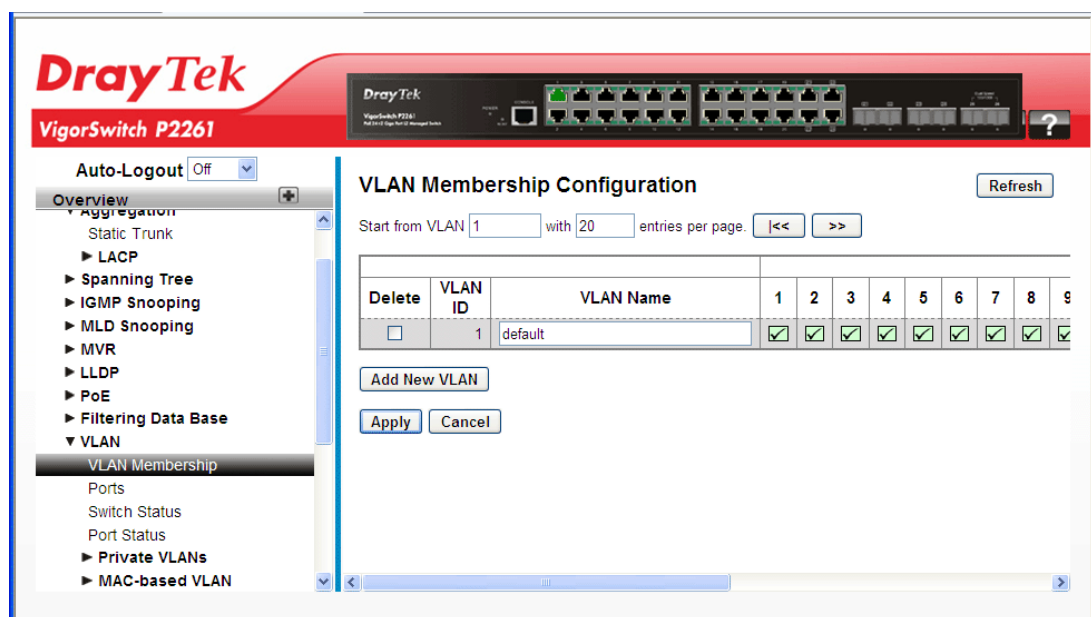

**Parameters description:**

Delete	Click it to delete the entry.
VLAN ID	Indicates the ID of this particular VLAN.
VLAN Name	Indicates the name of VLAN. VLAN Name can only contain alphabets or numbers. VLAN name should contain at least one alphabet. VLAN name can be edited for the existing VLAN entries or it can be added to the new entries.
Port Members	A row of check boxes for each port is displayed for each VLAN ID. To include a port in a VLAN, check the box. To remove or exclude the port from the VLAN, make sure the box is unchecked. By default, no ports are members, and all boxes are unchecked.
Adding a New VLAN	<p>Click to add a new VLAN ID. An empty row is added to the table, and the VLAN can be configured as needed. Legal values for a VLAN ID are 1 through 4095.</p> <p>The VLAN is enabled on the selected stack switch unit when you click on "Save". The VLAN is thereafter present on the other stack switch units, but with no port members. The check box is greyed out when VLAN is displayed on other stacked switches, but user can add member ports to it. A VLAN without any port members on any stack unit will be deleted when you click "Apply".</p> <p>The button can be used to undo the addition of new VLANs.</p>
Refresh	The simple counts will be refreshed manually when user use mouse to click on "Refresh" button.

After finished the above settings, click **Apply** to save the configuration. The settings will take effect.

### 2.3.42 VLAN – Ports

**Function name:**

VLAN – Ports

**Function description:**

The function in VLAN Tag Rule Setting, user can input VID number to each port. The range of VID number is from 1 to 4094. User also can choose ingress filtering rules to each port. There are two ingress filtering rules which can be applied to the switch. The Ingress Filtering Rule 1 is “forward only packets with VID matching this port’s configured VID”. The Ingress Filtering Rule 2 is “drop untagged frame”. You can also select the Role of each port as Access, Trunk, or Hybrid.



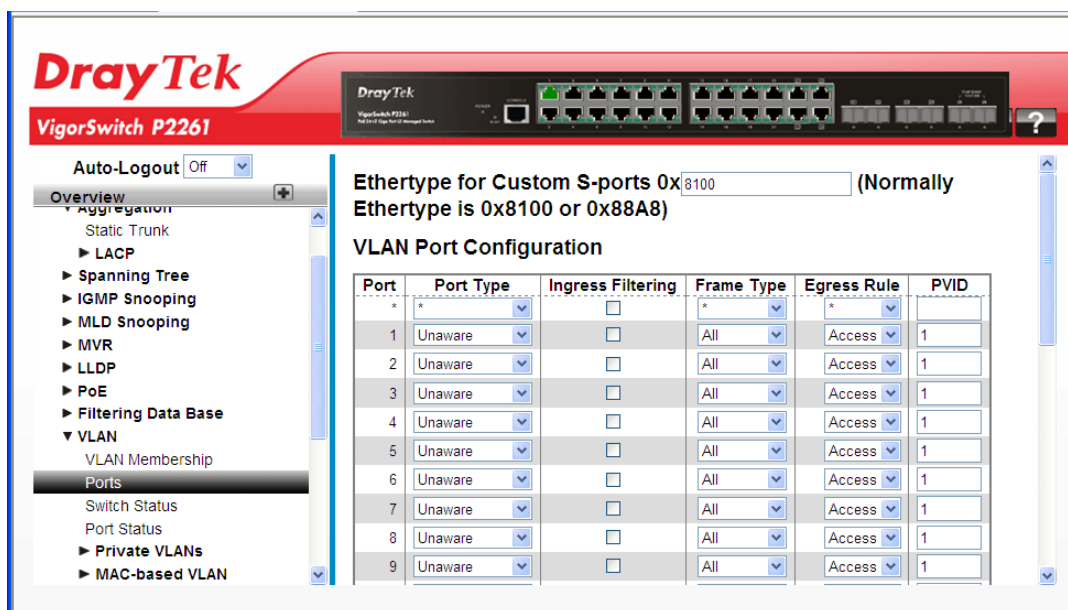

### Parameters description:

Ethertype for Custom S-ports	This field specifies the ether type used for Custom S-ports. This is a global setting for all the Custom S-ports.
Port	This is the logical port number of this row.
Port Type	Port can be one of the following types: Unaware, Customer port(C-port), Service port(S-port), Custom Service port(S-custom-port)  If Port Type is Unaware, all frames are classified to the Port VLAN ID and tags are not removed.
Ingress Filtering	Enable ingress filtering on a port by checking the box. This parameter affects VLAN ingress processing. If ingress filtering is enabled and the ingress port is not a member of the classified VLAN of the frame, the frame is discarded. By default, ingress filtering is disabled (no checkmark).
Frame Type	Determines whether the port accepts all frames or only tagged/untagged frames. This parameter affects VLAN ingress processing. If the port only accepts tagged frames, untagged frames received on the port are discarded. By default, the field is set to All.
Egress Rule	Determines what device the port connects to. If the port connects to VLAN-unaware devices, such as terminal/work station, Access link should be used. If the port connect to VLAN-aware devices, for example, switch connect to switch, Trunk link should be used. Hybrid link is used for more flexible application.  Hybrid: If the tag of tagged frame is as the same as PVID, the tag of the frame will be removed. The frame become an untagged frame and transmitted.  Any other tagged frame whose tag value is different from PVID is transmitted directly.

	Trunk: all tagged frames with any tag value are transmitted. Access: The tag of any tagged frame will be removed to become an untagged frame. These untagged frames will be transmitted.
PVID	Configures the VLAN identifier for the port. The allowed values are 1 through 4095. The default value is 1. Note: The port must be a member of the same VLAN as the Port VLAN ID.

After finished the above settings, click **Apply** to save the configuration. The settings will take effect.

## 2.3.43 VLAN – Switch Status

**Function name:**

VLAN – Switch Status

**Function description:**

The function is used to gather the information of all VLAN status and report it by the order of Static NAS MVRP MVP Voice VLAN MSTP GVRP Combined.

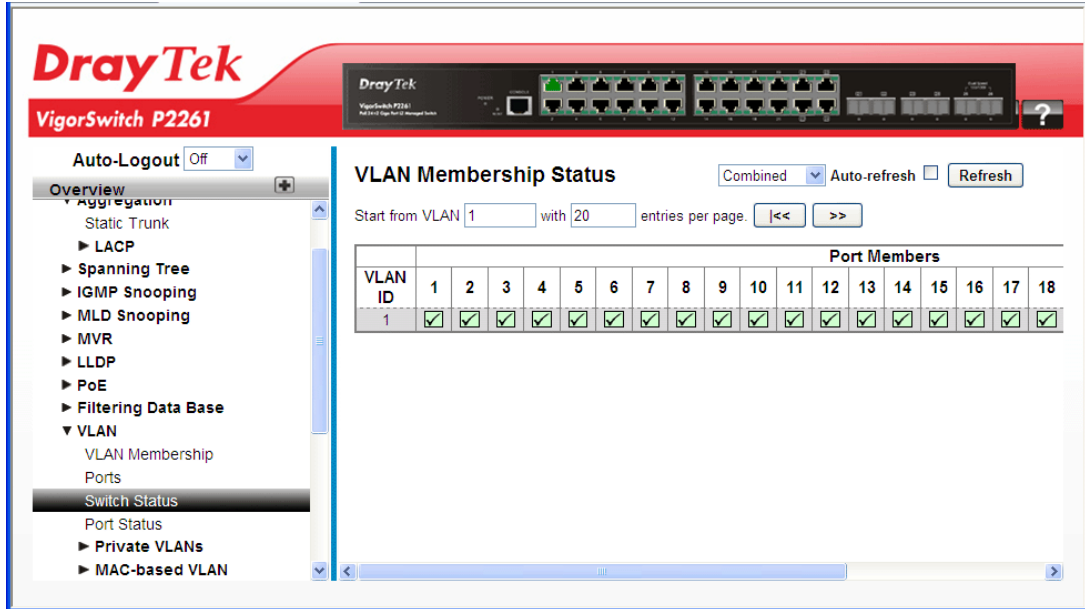

**Parameters description:**

**VLAN USER**

VLAN User module uses services of the VLAN management functionality to configure VLAN memberships and VLAN port configurations such as PVID and UVID. Currently we support the following VLAN user types:

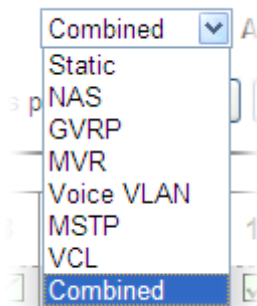

CLI/Web/SNMP: These are referred to as static.

NAS: NAS provides port-based authentication, which involves communications between a Supplicant, Authenticator, and an Authentication Server.

GVRP: GARP VLAN Registration Protocol (GVRP) allows dynamic registration and deregistration of VLANs on ports on a VLAN bridged network.

MVR: MVR is used to eliminate the need to duplicate

	<p>multicast traffic for subscribers in each VLAN. Multicast traffic for all channels is sent only on a single (multicast) VLAN.</p> <p>Voice VLAN: Voice VLAN is a VLAN configured specially for voice traffic typically originating from IP phones.</p> <p>MSTP: The 802.1s Multiple Spanning Tree protocol (MSTP) uses VLANs to create multiple spanning trees in a network, which significantly improves network resource utilization while maintaining a loop-free environment.</p>
VLAN ID	Indicates the ID of this particular VLAN.
Auto refresh	The simple counts will be refreshed automatically on the UI screen.
Refresh	The simple counts will be refreshed manually when user use mouse to click on “Refresh” button.

### 2.3.44 VLAN – Port Status

**Function name:**

VLAN – Port Status

**Function description:**

The function gathers the information of all VLAN status and reports it by the order of Static NAS MVRP MVP Voice VLAN MSTP GVRP Combined.

**DrayTek VigorSwitch P2261**

Auto-Logout: Off

VLAN Port Status for Static user (Static) Auto-refresh Refresh

Port	PVID	Port Type	Ingress Filtering	Frame Type	Tx Tag	UVID	Conflicts
1	1	UnAware	Disabled	All	Untag_all		No
2	1	UnAware	Disabled	All	Untag_all		No
3	1	UnAware	Disabled	All	Untag_all		No
4	1	UnAware	Disabled	All	Untag_all		No
5	1	UnAware	Disabled	All	Untag_all		No
6	1	UnAware	Disabled	All	Untag_all		No
7	1	UnAware	Disabled	All	Untag_all		No
8	1	UnAware	Disabled	All	Untag_all		No
9	1	UnAware	Disabled	All	Untag_all		No
10	1	UnAware	Disabled	All	Untag_all		No
11	1	UnAware	Disabled	All	Untag_all		No
12	1	UnAware	Disabled	All	Untag_all		No
13	1	UnAware	Disabled	All	Untag_all		No
14	1	UnAware	Disabled	All	Untag_all		No
15	1	UnAware	Disabled	All	Untag_all		No

**Parameters description:**

VLAN USER	<p>VLAN User module uses services of the VLAN management functionality to configure VLAN memberships and VLAN port configurations such as PVID and UVID. Currently we support the following VLAN user types:</p>
-----------	--

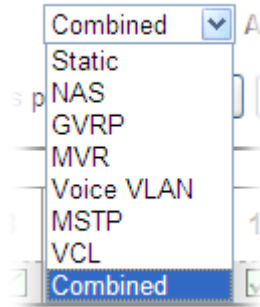

CLI/Web/SNMP: These are referred to as static.

NAS: NAS provides port-based authentication, which involves communications between a Supplicant, Authenticator, and an Authentication Server.

GVRP: GARP VLAN Registration Protocol (GVRP) allows dynamic registration and deregistration of VLANs on ports on a VLAN bridged network.

MVR: MVR is used to eliminate the need to duplicate multicast traffic for subscribers in each VLAN. Multicast traffic for all channels is sent only on a single (multicast) VLAN.

Voice VLAN: Voice VLAN is a VLAN configured specially for voice traffic typically originating from IP phones.

MSTP: The 802.1s Multiple Spanning Tree protocol (MSTP) uses VLANs to create multiple spanning trees in a network, which significantly improves network resource utilization while maintaining a loop-free environment.

Port	The logical port for the settings contained in the same row.
PVID	Shows the VLAN identifier for that port. The allowed values are 1 through 4095. The default value is 1.
Port Type	Shows the Port Type. Port type can be any of Unaware, C-port, S-port, Custom S-port.  If Port Type is Unaware, all frames are classified to the Port VLAN ID and tags are not removed.  C-port is Customer Port. S-port is Service port. Custom S-port is S-port with Custom TPID.
Ingress Filtering	Shows the ingress filtering on a port. This parameter affects VLAN ingress processing. If ingress filtering is enabled and the ingress port is not a member of the classified VLAN, the frame is discarded.
Frame Type	Shows whether the port accepts all frames or only tagged frames. This parameter affects VLAN ingress processing. If the port only accepts tagged frames, untagged frames received on that port are discarded.
Tx Tag	Shows egress filtering frame status whether tagged or untagged.

UVID	Shows UVID (untagged VLAN ID). Port's UVID determines the packet's behaviour at the egress side.
Conflicts	Shows status of Conflicts whether exists or not. When a Volatile VLAN User requests to set VLAN membership or VLAN port configuration, the following conflicts can occur:  Functional Conflicts between features.  Conflicts due to hardware limitation.  Direct conflict between user modules.
Auto refresh	The simple counts will be refreshed automatically on the UI screen.
Refresh	The simple counts will be refreshed manually when user use mouse to click on "Refresh" button.

### 2.3.45 VLAN – Private VLANs – Private VLAN Membership

In a private VLAN, communication between ports in that private VLAN is not permitted. A VLAN can be configured as a private VLAN.

Private VLANs are based on the source port mask, and there are no connections to VLANs. This means that VLAN IDs and Private VLAN IDs can be identical.

A port must be a member of both a VLAN and a Private VLAN to be able to forward packets. By default, all ports are VLAN unaware and members of VLAN 1 and Private VLAN 1.

A VLAN unaware port can only be a member of one VLAN, but it can be a member of multiple Private VLANs.

**Function name:**

VLAN – Private VLANs – Private VLAN Membership

**Function description:**

The Private VLAN membership configurations for the switch can be monitored and modified here. Private VLANs can be added or deleted here. Port members of each Private VLAN can be added or removed here.

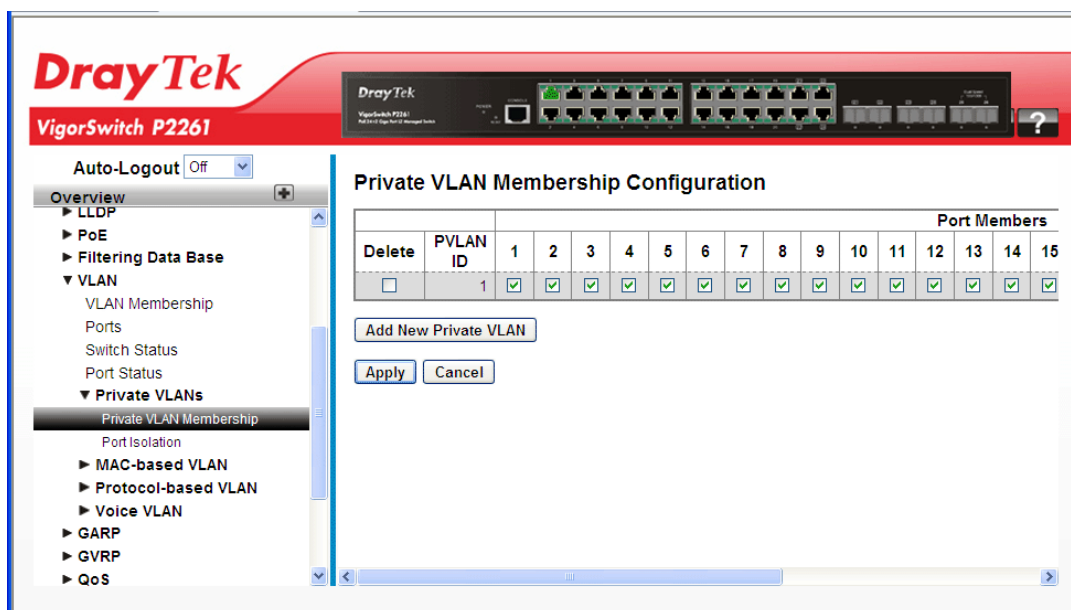

### Parameters description:

Delete	Check this box to delete the entry.
Private VLAN ID	Indicates the ID of this particular private VLAN.
Port Members	A row of check boxes for each port is displayed for each private VLAN ID. To include a port in a Private VLAN, check the box. To remove or exclude the port from the Private VLAN, make sure the box is unchecked. By default, no ports are members, and all boxes are unchecked.
Adding a New Private VLAN	<p>Click to add a new private VLAN ID. An empty row is added to the table, and the private VLAN can be configured as needed. The allowed range for a private VLAN ID is the same as the switch port number range. Any values outside this range are not accepted, and a warning message appears. Click "Reset" to discard the incorrect entry.</p> <p>The Private VLAN is enabled when you click "Apply".</p> <p>The button can be used to undo the addition of new Private VLANs.</p>

After finished the above settings, click **Apply** to save the configuration. The settings will take effect.

## 2.3.46 VLAN – Private VLANs – Port Isolation

Port Isolation provides for an apparatus and method to isolate ports on layer 2 switches on the same VLAN to restrict traffic flow. The apparatus comprises a switch having said plurality of ports, each port configured as a protected port or a non-protected port. An address table memory stores an address table having a destination address and port number pair. A forwarding map generator generates a forwarding map which is responsive to a destination address of a data packet. The method for isolating ports on a layer 2 switch comprises configuring each of the ports on the layer 2 switch as a protected port or a non-protected port. A destination address on an data packet is matched with a physical address on said layer 2 switch and a forwarding map is generated for the data packet based upon the destination address on the data packet. The data packet is then sent to the plurality of ports pursuant to the forwarding map generated based upon whether the ingress port was configured as a protected or non-protected port.

### Function name:

VLAN – Private VLANs – Port Isolation

### Function description:

The function is used for enabling or disabling port isolation on ports in a Private VLAN. A port member of a VLAN can be isolated to other isolated ports on the same VLAN and Private VLAN.

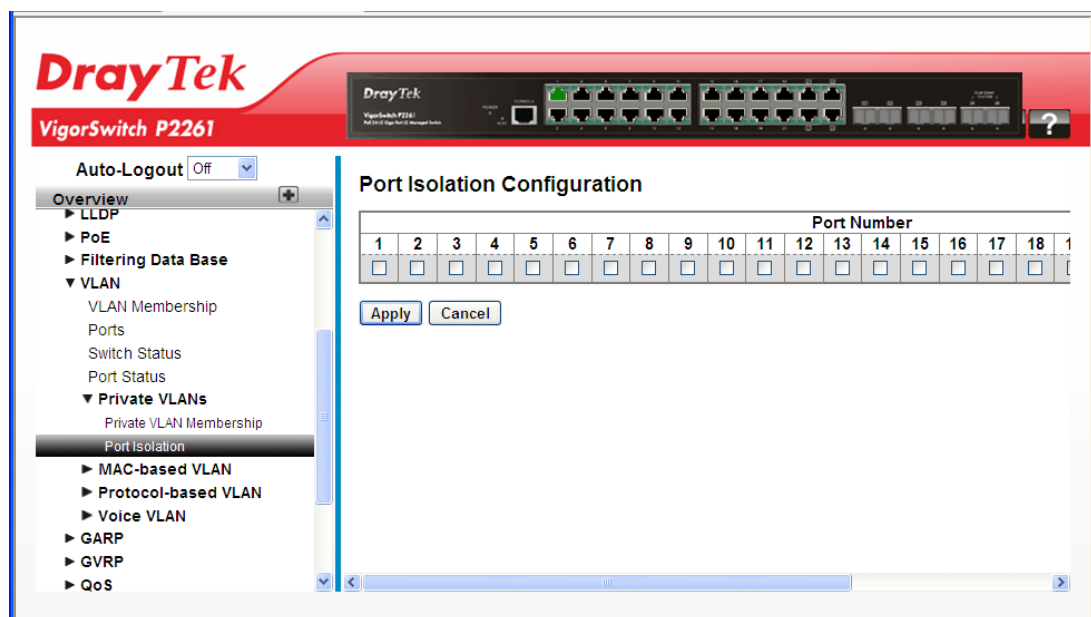

### Parameters description:

Port Members	A check box is provided for each port of a private VLAN. When checked, port isolation is enabled on that port. When unchecked, port isolation is disabled on that port. By default, port isolation is disabled on all ports.
--------------	--

After finished the above settings, click **Apply** to save the configuration. The settings will take effect.



## 2.3.47 VLAN – MAC-based VLAN – General Setup

MAC address-based VLAN decides the VLAN for forwarding an untagged frame based on the source MAC address of the frame.

A most common way of grouping VLAN members is by port, hence the name port-based VLAN. Typically, the device adds the same VLAN tag to untagged packets that are received through the same port. Later on, these packets can be forwarded in the same VLAN. Port-based VLAN is easy to configure, and applies to networks where the locations of terminal devices are relatively fixed. As mobile office and wireless network access gain more popularity, the ports that terminal devices use to access the networks are very often non-fixed. A device may access a network through Port A this time, but through Port B the next time. If Port A and Port B belong to different VLANs, the device will be assigned to a different VLAN the next time it accesses the network. As a result, it will not be able to use the resources in the old VLAN. On the other hand, if Port A and Port B belong to the same VLAN, after terminal devices access the network through Port B, they will have access to the same resources as those accessing the network through Port A do, which brings security issues. To provide user access and ensure data security in the mean time, the MAC-based VLAN technology is developed.

MAC-based VLANs group VLAN members by MAC address. With MAC-based VLAN configured, the device adds a VLAN tag to an untagged frame according to its source MAC address. MAC-based VLANs are mostly used in conjunction with security technologies such as 802.1X to provide secure, flexible network access for terminal devices

### Function name:

VLAN – MAC-based VLAN – General Setup

### Function description:

The function is used for adding and deleting MAC-based VLAN entries and assigning the entries to different ports. This page shows only static entries.

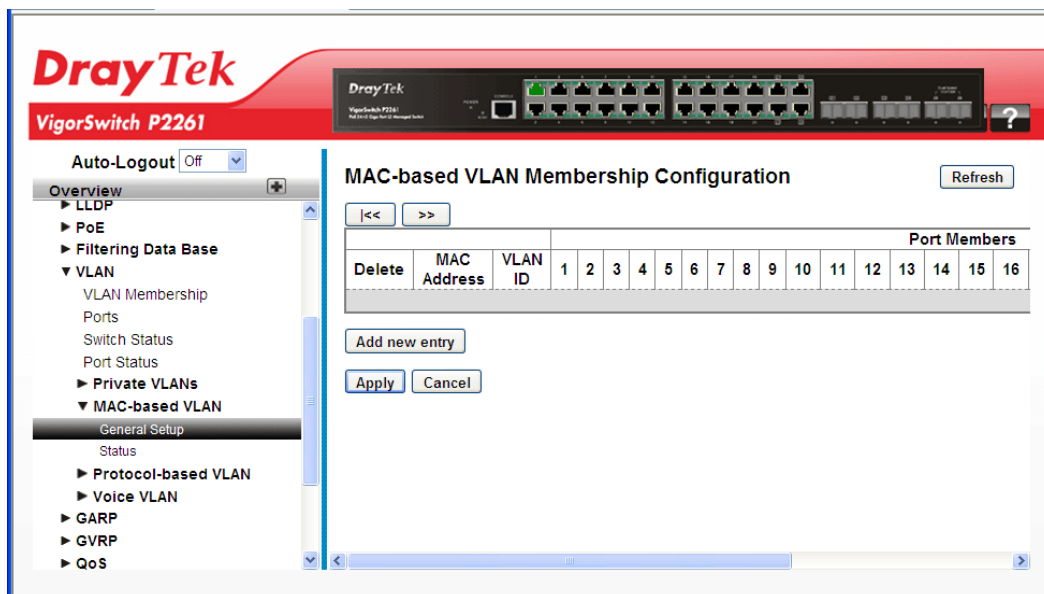

### Parameters description:

Delete	To delete a MAC-based VLAN entry, check this box and press Apply.
MAC Address	Indicates the MAC address.
VLAN ID	Indicates the VLAN ID.

Port Members	A row of check boxes for each port is displayed for each MAC-based VLAN entry. To include a port in a MAC-based VLAN, check the box. To remove or exclude the port from the MAC-based VLAN, make sure the box is unchecked. By default, no ports are members, and all boxes are unchecked.
Add new entry	<p>Click it to add a new MAC-based VLAN entry.</p> <p>An empty row is added to the table, and the MAC-based VLAN entry can be configured as needed. Any unicast MAC address can be configured for the MAC-based VLAN entry. No broadcast or multicast MAC addresses are allowed. Legal values for a VLAN ID are 1 through 4095.</p> <p>The MAC-based VLAN entry is enabled on the selected stack switch unit when you click on "Save". A MAC-based VLAN without any port members on any stack unit will be deleted when you click Apply.</p> <p>The button can be used to undo the addition of new MAC-based VLANs.</p>
Refresh	The simple counts will be refreshed manually when user use mouse to click on "Refresh" button.

After finished the above settings, click **Apply** to save the configuration. The settings will take effect.

## 2.3.48 VLAN – MAC-based VLAN – Status

### Function name:

VLAN – MAC-based VLAN – Status

### Function description:

The function is used to show MAC-based VLAN entries configured by various MAC-based VLAN users.

**Note:** NAS provides port-based authentication, which involves communications between a Supplicant, Authenticator, and an Authentication Server.

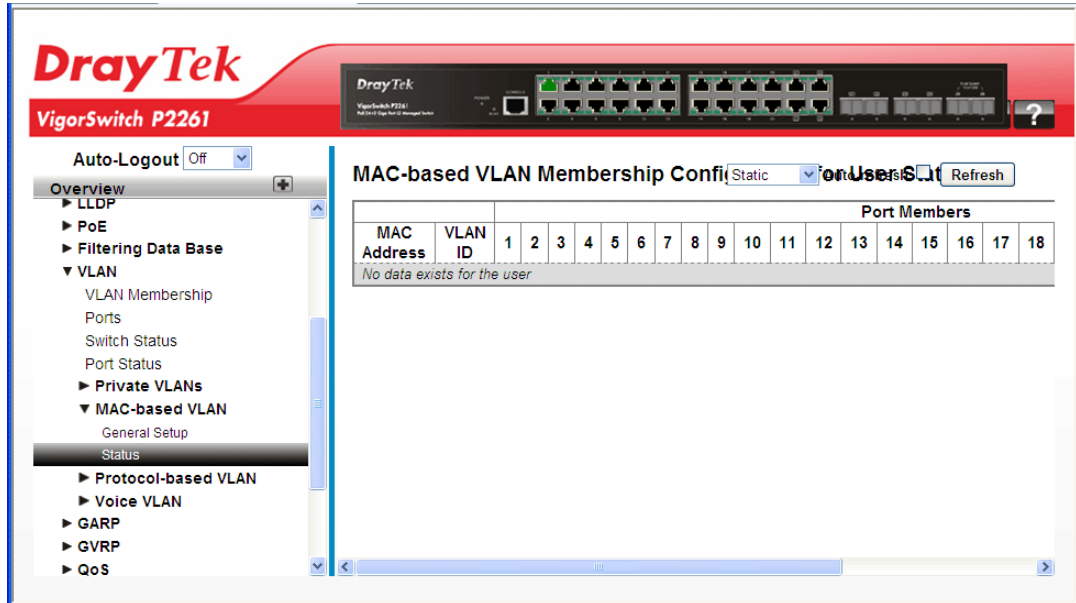

### Parameters description:

MAC Address	Indicates the MAC address.
VLAN ID	Indicates the VLAN ID.
Port Members	Port members of the MAC-based VLAN entry.
Auto refresh	The simple counts will be refreshed automatically on the UI screen.
Refresh	The simple counts will be refreshed manually when user use mouse to click on “Refresh” button.

After finished the above settings, click **Apply** to save the configuration. The settings will take effect.

## 2.3.49 VLAN – Protocol-based VLAN – Protocol Group

This section describe Protocol -based VLAN, The Switch support Protocol include Ethernet LLC SNAP Protocol, and LLC.

The Logical Link Control (LLC) data communication protocol layer is the upper sub-layer of the Data Link Layer (which is itself layer 2, just above the Physical Layer) in the seven-layer OSI reference model. It provides multiplexing mechanisms that make it possible for several network protocols (IP, IPX, Decnet and Appletalk) to coexist within a multipoint network and to be transported over the same network media, and can also provide flow control and automatic repeat request (ARQ) error management mechanisms.

### SNAP

The Subnetwork Access Protocol (SNAP) is a mechanism for multiplexing, on networks using IEEE 802.2 LLC, more protocols than can be distinguished by the 8-bit 802.2 Service Access Point (SAP) fields. SNAP supports identifying protocols by Ethernet type field values; it also supports vendor-private protocol identifier spaces. It is used with IEEE 802.3, IEEE 802.4, IEEE 802.5, IEEE 802.11 and other IEEE 802 physical network layers, as well as with non-IEEE 802 physical network layers such as FDDI that use 802.2 LLC.

### Function name:

VLAN – Protocol-based VLAN – Protocol Group

### Function description:

The function is used to add new protocols to Group Name (unique for each Group) mapping entries as well as used to allow you to see and delete the already mapped entries.

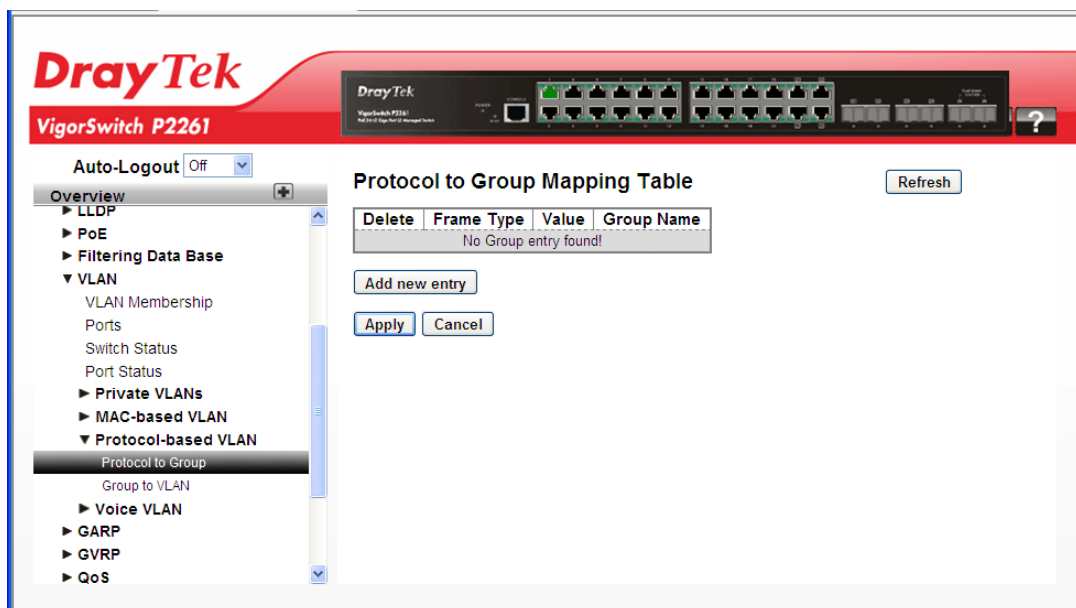

### Parameters description:

Delete	Check this box to delete the entry.
Frame Type	<p>Frame Type can have one of the following values:</p> <ul style="list-style-type: none"> <li>● Ethernet</li> <li>● LLC</li> <li>● SNAP</li> </ul> <p><b>Note:</b> On changing the Frame type field, valid value of the</p>

	following text field will vary depending on the new frame type you selected.
Value	<p>Valid value that can be entered in this text field depends on the option selected from the preceding Frame Type selection menu.</p> <p>Below is the criteria for three different Frame Types:</p> <ul style="list-style-type: none"> <li>● For Ethernet: Values in the text field when Ethernet is selected as a Frame Type is called etype. Valid values for etype ranges from 0x0600-0xffff</li> <li>● For LLC: Valid value in this case is comprised of two different sub-values. <ul style="list-style-type: none"> <li>a. DSAP: 1-byte long string (0x00-0xff)</li> <li>b. SSAP: 1-byte long string (0x00-0xff)</li> </ul> </li> <li>● For SNAP: Valid value in this case also is comprised of two different sub-values. <ul style="list-style-type: none"> <li>a. OUI: OUI (Organizationally Unique Identifier) is value in format of xx-xx-xx where each pair (xx) in string is a hexadecimal value ranges from 0x00-0xff.</li> <li>b. PID: If the OUI is hexadecimal 000000, the protocol ID is the Ethernet type (EtherType) field value for the protocol running on top of SNAP; if the OUI is an OUI for a particular organization, the protocol ID is a value assigned by that organization to the protocol running on top of SNAP. In other words, if value of OUI field is 00-00-00 then value of PID will be etype (0x0600-0xffff) and if value of OUI is other than 00-00-00 then valid value of PID will be any value from 0x0000 to 0xffff.</li> </ul> </li> </ul>
Group Name	<p>A valid Group Name is a unique 16-character long string for every entry which consists of a combination of alphabets (a-z or A-Z) and integers (0-9).</p> <p><b>Note:</b> special character and underscore ( _ ) are not allowed.</p>
Add new entry	<p>Click to add a new entry in mapping table. An empty row is added to the table; Frame Type, Value and the Group Name can be configured as needed.</p> <p>The button can be used to undo the addition of new entry.</p>
Refresh	<p>The simple counts will be refreshed manually when user use mouse to click on “Refresh” button.</p>

After finished the above settings, click **Apply** to save the configuration. The settings will take effect.

## 2.3.50 VLAN – Protocol-based VLAN – Group to VLAN

### Function name:

VLAN – Protocol-based VLAN – Group to VLAN

### Function description:

The function is used to map an already configured Group Name to a VLAN for the selected item.

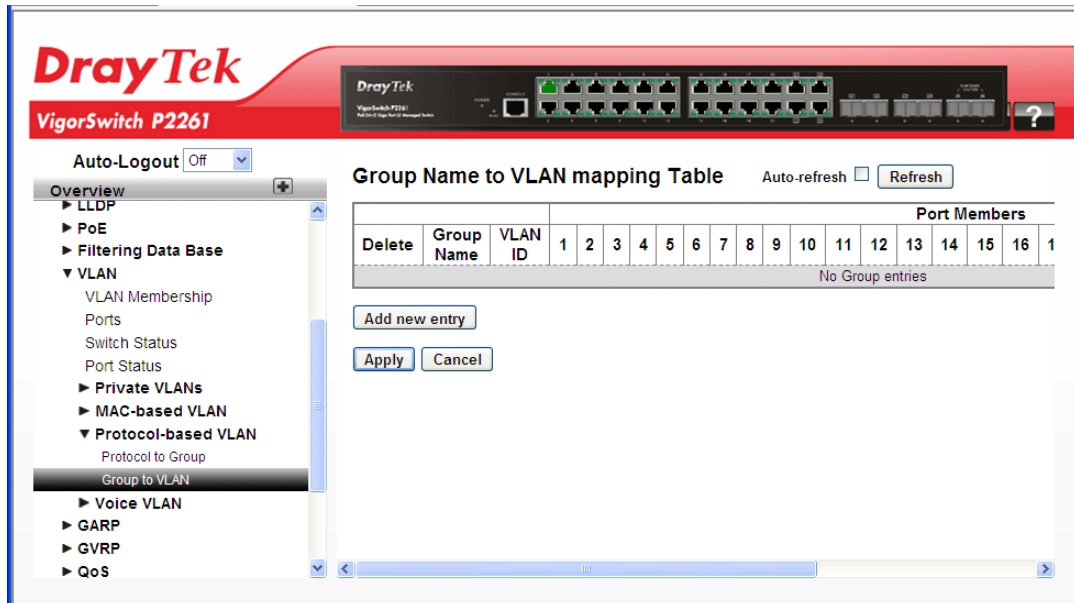

### Parameters description:

Delete	Check this box to delete the entry.
Group Name	A valid Group Name is a string of at most 16 characters which consists of a combination of alphabets (a-z or A-Z) and integers (0-9), no special character is allowed. Whichever group name you try mapping to a VLAN must be present in Protocol to Group mapping table and must not be pre-used by any other existing mapping entry on this page.
VLAN ID	Indicates the ID to which Group Name will be mapped. A valid VLAN ID ranges from 1-4095.
Port Members	A row of check boxes for each port is displayed for each Group Name to VLAN ID mapping. To include a port in a mapping, check the box. To remove or exclude the port from the mapping, make sure the box is unchecked. By default, no ports are members, and all boxes are unchecked.
Add new entry	Click to add a new entry in mapping table. An empty row is added to the table, the Group Name, VLAN ID and port members can be configured as needed. Legal values for a VLAN ID are 1 through 4095. The button can be used to undo the addition of new entry.
Auto refresh	The simple counts will be refreshed automatically on the UI screen.

Refresh	The simple counts will be refreshed manually when user use mouse to click on “Refresh” button.
---------	--

After finished the above settings, click **Apply** to save the configuration. The settings will take effect.

### 2.3.51 Voice VLAN – General Setup

Voice VLAN is VLAN configured specially for voice traffic. By adding the ports with voice devices attached to voice VLAN, we can perform QoS-related configuration for voice data, ensuring the transmission priority of voice traffic and voice quality.

**Function name:**

Voice VLAN – General Setup

**Function description:**

The Voice VLAN feature enables voice traffic forwarding on the Voice VLAN, then the switch can classify and schedule network traffic. It is recommended that there must be two VLANs on a port - one for voice, one for data. Before connecting the IP device to the switch, the IP phone should configure the voice VLAN ID correctly. It should be configured through its own GUI.

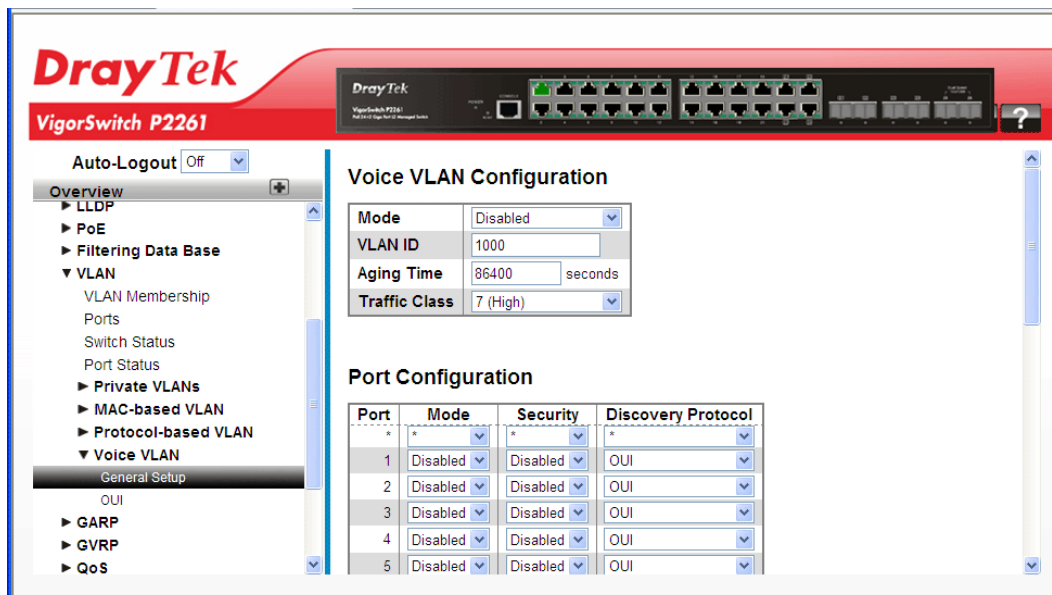

**Parameters description:**

Voice VLAN Configuration	
Mode	Indicates the Voice VLAN mode operation. We must disable MSTP feature before we enable Voice VLAN. It can avoid the conflict of ingress filtering. Possible modes are: Enabled: Enable Voice VLAN mode operation. Disabled: Disable Voice VLAN mode operation.
VLAN ID	Indicates the Voice VLAN ID. It should be a unique VLAN ID in the system and cannot equal each port PVID. It is a conflict in configuration if the value equals management VID, MVR VID, PVID etc. The allowed range is 1 to 4095.
Aging Time	Indicates the Voice VLAN secure learning aging time. The allowed range is 10 to 10000000 seconds. It is used when

	security mode or auto detect mode is enabled. In other cases, it will be based on hardware aging time. The actual aging time will be situated between the [age_time; 2 * age_time] interval.
Traffic Class	Indicates the Voice VLAN traffic class. All traffic on the Voice VLAN will apply this class.
<b>Port Configuration</b>	
Port	Switch port number.
Mode	<p>Indicates the Voice VLAN port mode.</p> <p>When the port mode isn't equal disabled, we must disable MSTP feature before we enable Voice VLAN. It can avoid the conflict of ingress filtering.</p> <p>Possible port modes are:</p> <p>Disabled: Disjoin from Voice VLAN.</p> <p>Auto: Enable auto detect mode. It detects whether there is VoIP phone attached to the specific port and configures the Voice VLAN members automatically.</p> <p>Forced: Force join to Voice VLAN.</p>
Security	<p>Indicates the Voice VLAN port security mode. When the function is enabled, all non-telephonic MAC addresses in the Voice VLAN will be blocked for 10 seconds. Possible port modes are:</p> <p>Enabled: Enable Voice VLAN security mode operation.</p> <p>Disabled: Disable Voice VLAN security mode operation.</p>
Discovery Protocol	<p>Indicates the Voice VLAN port discovery protocol. It will only work when auto detect mode is enabled. We should enable LLDP feature before configuring discovery protocol to "LLDP" or "Both". Changing the discovery protocol to "OUI" or "LLDP" will restart auto detection process.</p> <p>Possible discovery protocols are:</p> <p>OUI: Detect telephony device by OUI address.</p> <p>LLDP: Detect telephony device by LLDP.</p> <p>Both: Both OUI and LLDP.</p>

After finished the above settings, click **Apply** to save the configuration. The settings will take effect.



## 2.3.52 Voice VLAN – QUI

### Function name:

Voice VLAN – QUI

### Function description:

The function is used to Configure VOICE VLAN OUI table. The maximum entry number is 16. Modifying the OUI table will restart auto detection of OUI process.

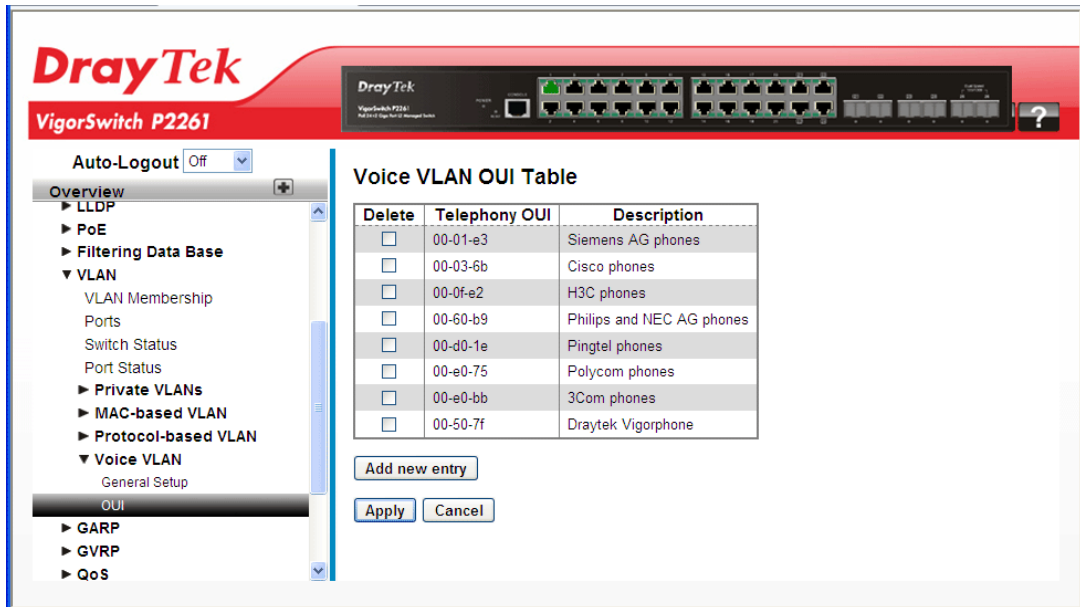

### Parameters description:

Delete	Check this box to delete the entry.
Telephony OUI	A telephony OUI address is a globally unique identifier assigned to a vendor by IEEE. It must be 6 characters long and the input format is "xx-xx-xx" (x is a hexadecimal digit).
Description	The description of OUI address. Normally, it describes which vendor telephony device it belongs to. The allowed string length is 0 to 32.
Add new entry	Click to add a new entry in mapping table. An empty row is added to the table, the Group Name, VLAN ID and port members can be configured as needed. Legal values for a VLAN ID are 1 through 4095. The button can be used to undo the addition of new entry.

After finished the above settings, click **Apply** to save the configuration. The settings will take effect.

## 2.3.53 GARP – General Setup

The Generic Attribute Registration Protocol (GARP) provides a generic framework whereby devices in a bridged LAN, e.g. end stations and switches, can register and de-register attribute values, such as VLAN Identifiers, with each other. In doing so, the attributes are propagated to devices in the bridged LAN, and these devices form a reachability tree that is a subset of an active topology. GARP defines the architecture, rules

of operation, state machines and variables for the registration and de-registration of attribute values.

A GARP participation in a switch or an end station consists of a GARP application component, and a GARP Information Declaration (GID) component associated with each port or the switch. The propagation of information between GARP participants for the same application in a bridge is carried out by the GARP Information Propagation (GIP) component. Protocol exchanges take place between GARP participants by means of LLC Type 1 services, using the group MAC address and PDU format defined for the GARP application concerned.

**Function name:**

GARP – General Setup

**Function description:**

The function is used to configure the basic GARP Configuration settings for all switch ports.

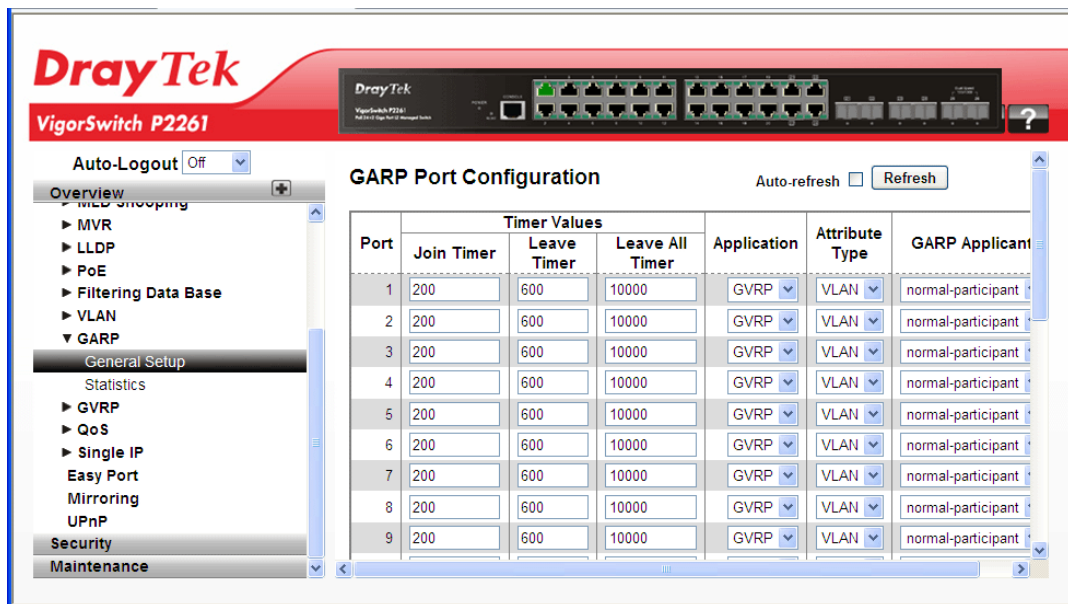

**Parameters description:**

Port	The Port column shows the list of ports for which you can configure GARP settings.
Timer Values	Three different timers can be configured on this page: 1. Join Timer - The default value for Join timer is 200ms. 2. Leave Timer - The range of values for Leave Time is 600-1000ms. The default value for Leave Timer is 600ms. 3. Leave All Timer - The default value for Leave All Timer is 10000ms
Application	Currently only supported application is GVRP.
Attribute Type	Currently only supported Attribute Type is VLAN.
GARP Applicant	This configuration is used to configure the Applicant state machine behavior for GARP on a particular port locally. Applicant state machine behavior for GARP on a particular port locally. <ul style="list-style-type: none"> <li>● normal-participate: In this mode the Applicant state</li> </ul>

	<p>machine will operate normally in GARP protocol exchanges.</p> <ul style="list-style-type: none"> <li>● non-participate: In this mode the Applicant state machine will not participate in the protocol operation.</li> </ul> <p>The default configuration is normal participant.</p>
Auto refresh	The simple counts will be refreshed automatically on the UI screen.
Refresh	The simple counts will be refreshed manually when user use mouse to click on “Refresh” button.

After finished the above settings, click **Apply** to save the configuration. The settings will take effect.

### 2.3.54 GARP – Statistics

**Function name:**

GARP – Statistics

**Function description:**

The function is used to display port statistics of GARP for all switch ports.

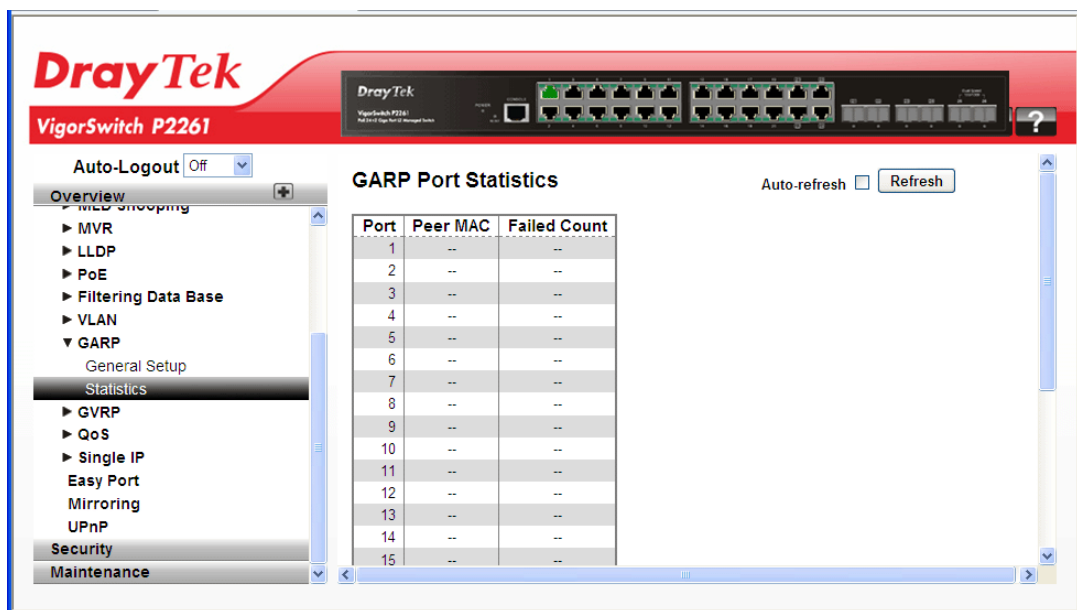

**Parameters description:**

Port	The Port column shows the list of all ports for which per port GARP statistics are shown.
Peer MAC	Peer MAC is MAC address of the neighbour Switch from with GARP frame is received.
Failed Count	Explain Failed count here...
Auto refresh	The simple counts will be refreshed automatically on the UI screen.
Refresh	The simple counts will be refreshed manually when user use mouse to click on “Refresh” button.

After finished the above settings, click **Apply** to save the configuration. The settings will take effect.

### 2.3.55 GVRP – General Setup

GVRP is an application based on Generic Attribute Registration Protocol (GARP), mainly used to automatically and dynamically maintain the group membership information of the VLANs. The GVRP offers the function providing the VLAN registration service through a GARP application. It makes use of GARP Information Declaration (GID) to maintain the ports associated with their attribute database and GARP Information Propagation (GIP) to communicate among switches and end stations. With GID information and GIP, GVRP state machine maintain the contents of Dynamic VLAN Registration Entries for each VLAN and propagate these information to other GVRP-aware devices to setup and update their knowledge database, the set of VLANs associated with currently active members, and through which ports these members can be reached.

**Function name:**

Aggregation – Static Trunk

**Function description:**

The function is used to configure the basic GVRP Configuration settings for all switch ports.

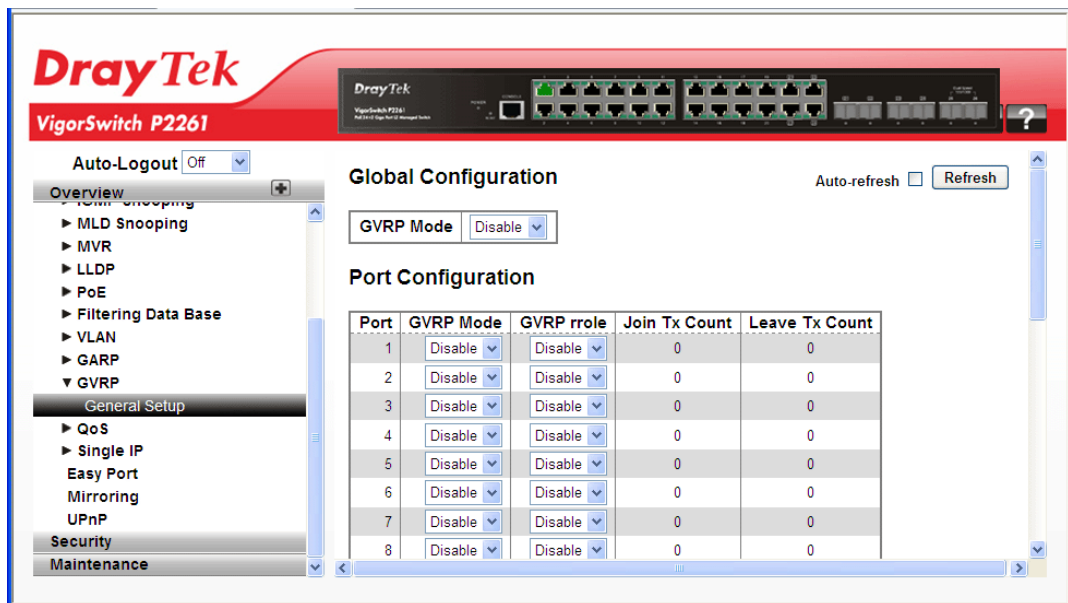

**Parameters description:**

Global Configuration	
GVRP Mode	GVRP Mode is a global setting, to enable the GVRP globally select 'Enable' from menu and to disable GVRP globally select 'Disable'. In stacking, this configuration command sends message to all the slaves connected in stack. Default value of Global MVRP Mode is Disable.
Port Configuration	
Port	The Port column shows the list of ports for which you can configure per port GVRP settings.

GVRP Mode	Enable/disable GVRP Mode on this port. The default configuration is Disable.
GVRP Role	Enable/disable GVRP role on this port. The default configuration is Disable.
Join Tx Count	Explain Join Tx Count here.
Leave Tx Count	Explain Leave Tx Count here.
Auto refresh	The simple counts will be refreshed automatically on the UI screen.
Refresh	The simple counts will be refreshed manually when user use mouse to click on “Refresh” button.

After finished the above settings, click **Apply** to save the configuration. The settings will take effect.

### 2.3.56 QoS – Port Classification

The switch supports four QoS queues per port with strict or weighted fair queuing scheduling. It supports QoS Control Lists (QCL) for advance programmable QoS classification, based on IEEE 802.1p, Ethertype, VID, IPv4/IPv6 DSCP and UDP/TCP ports and ranges.

High flexibility is in the classification of incoming frames to a QoS class. The QoS classification looks for information up to Layer 4, including IPv4 and IPv6 DSCP, IPv4 TCP/UDP port numbers, and user priority of tagged frames. This QoS classification mechanism is implemented in a QoS control list (QCL). The QoS class assigned to a frame is used throughout the device for providing queuing, scheduling, and congestion control guarantees to the frame according to what was configured for that specific QoS class.

The switch support advanced memory control mechanisms providing excellent performance of all QoS classes under any traffic scenario, including jumbo frame. A super priority queue with dedicated memory and strict highest priority will be in the arbitration. The ingress super priority queue allows traffic recognized as CPU traffic to be received and queued for transmission to the CPU even when all the QoS class queues are congested.

**Function name:**

QoS – Port Classification

**Function description:**

The function is to configure the basic QoS Ingress Classification settings for all switch ports.

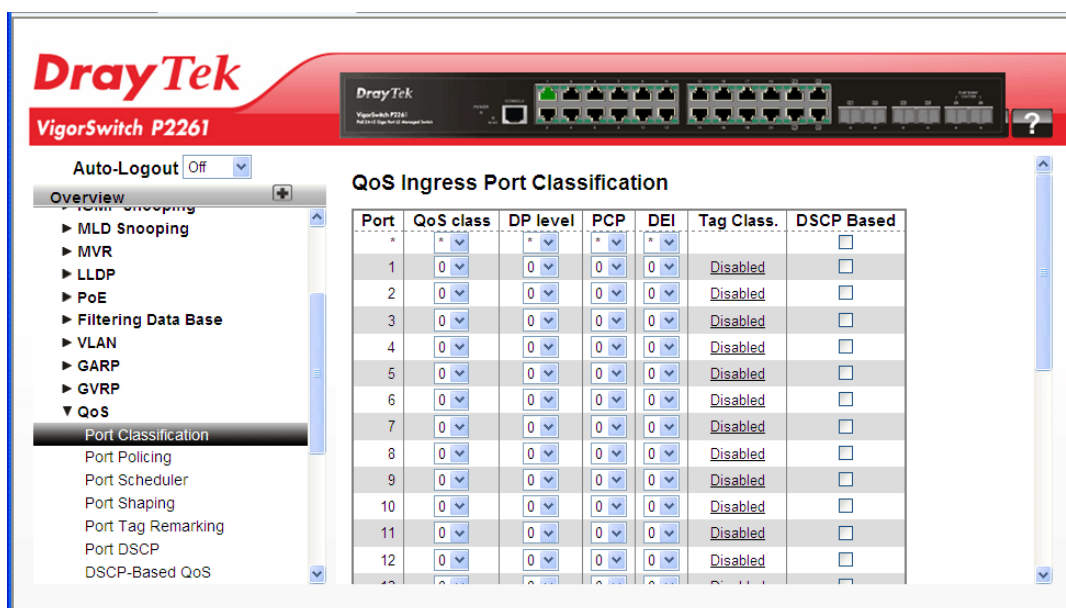

### Parameters description:

Port	The port number for which the configuration below applies.
QoS class	Controls the default QoS class, i.e., the QoS class for frames not classified in any other way. There is a one to one mapping between QoS class, queue and priority. A QoS class of 0 (zero) has the lowest priority.
DP level	Controls the default DP level, i.e., the DP level for frames not classified in any other way.
PCP	Controls the default PCP for untagged frames.
DEI	Controls the default DEI for untagged frames.
Tag Class	Shows the classification mode for tagged frames on this port. Disabled: Use default QoS class and DP level for tagged frames. Enabled: Use mapped versions of PCP and DEI for tagged frames. Click on the mode in order to configure the mode and/or mapping.
DSCP Based	Click to Enable DSCP Based QoS Ingress Port Classification.

After finished the above settings, click **Apply** to save the configuration. The settings will take effect.

## 2.3.57 QoS – Port Policing

### Function name:

QoS – Port Policing

### Function description:

The function is used to provide an overview of f QoS Ingress Port Policers for all switch ports. The Port Policing is useful in constraining traffic flows and marking frames above specific rates. Policing is primarily useful for data flows and voice or video flows because voice and video usually maintains a steady rate of traffic.

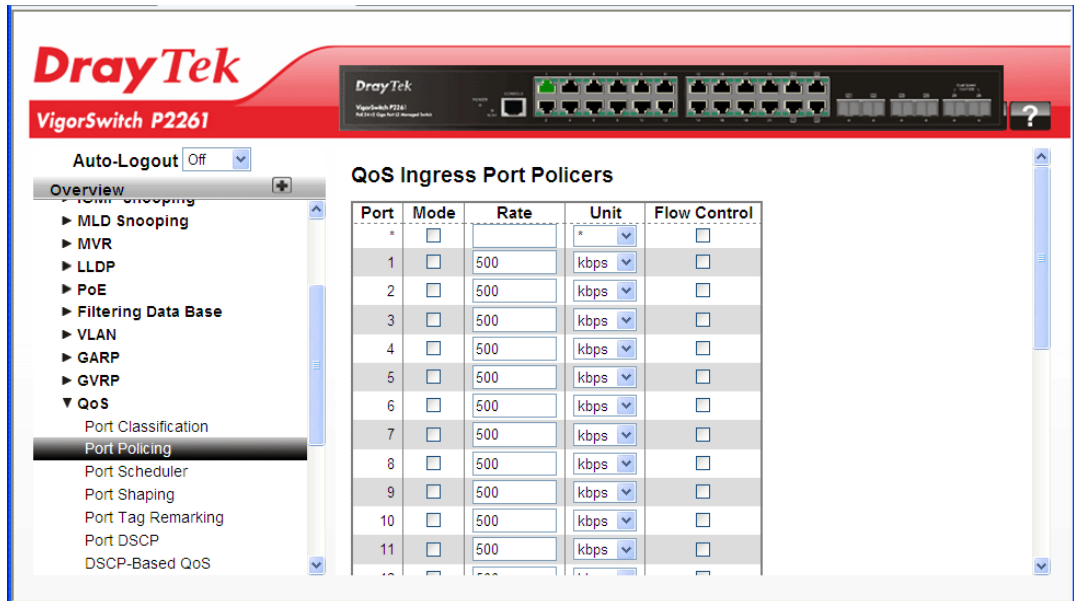

### Parameters description:

Port	The port number for which the configuration below applies.
Mode	To evoke which Port you need to enable the QoS Ingress Port Policers function. Controls whether the policer is enabled on this switch port.
Rate	Controls the rate for the policer. The default value is 500. This value is restricted to 100-1000000 when the "Unit" is "kbps" or "fps", and it is restricted to 1-1000 when the "Unit" is "Mbps" or "kfps".
Unit	Select the unit of rate including kbps, Mbps, fps and kfps. The default is kbps.
Flow Control	Check it to enable or disable flow control on port.

After finished the above settings, click **Apply** to save the configuration. The settings will take effect.

### 2.3.58 QoS – Port Scheduler

**Function name:**

QoS – Port Scheduler

**Function description:**

The function is used to provide an overview of QoS Egress Port Schedulers for all switch ports.

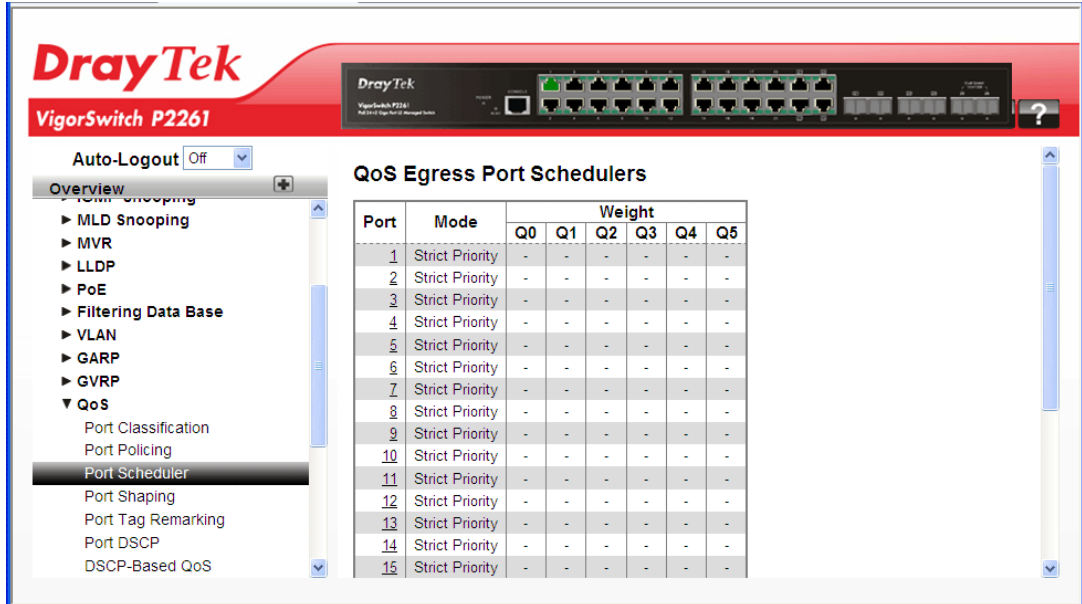

**Parameters description:**

Port	The logical port for the settings contained in the same row. Click on the port number in order to configure the schedulers.
Mode	Shows the scheduling mode for this port.
Weight (Q0 – Qn)	Shows the weight for this queue and port.



## 2.3.59 QoS – Port Shaping

**Function name:**

QoS – Port Shaping

**Function description:**

The function is to provide an overview of QoS Egress Port Shapers for all switch ports.

The screenshot shows the DrayTek VigorSwitch P2261 web interface. The main content area is titled "QoS Egress Port Shapers" and contains a table with the following structure:

Port	Shapers								Port
	Q0	Q1	Q2	Q3	Q4	Q5	Q6	Q7	
1	disabled	disabled	disabled	disabled	disabled	disabled	disabled	disabled	disabled
2	disabled	disabled	disabled	disabled	disabled	disabled	disabled	disabled	disabled
3	disabled	disabled	disabled	disabled	disabled	disabled	disabled	disabled	disabled
4	disabled	disabled	disabled	disabled	disabled	disabled	disabled	disabled	disabled
5	disabled	disabled	disabled	disabled	disabled	disabled	disabled	disabled	disabled
6	disabled	disabled	disabled	disabled	disabled	disabled	disabled	disabled	disabled
7	disabled	disabled	disabled	disabled	disabled	disabled	disabled	disabled	disabled
8	disabled	disabled	disabled	disabled	disabled	disabled	disabled	disabled	disabled
9	disabled	disabled	disabled	disabled	disabled	disabled	disabled	disabled	disabled
10	disabled	disabled	disabled	disabled	disabled	disabled	disabled	disabled	disabled
11	disabled	disabled	disabled	disabled	disabled	disabled	disabled	disabled	disabled
12	disabled	disabled	disabled	disabled	disabled	disabled	disabled	disabled	disabled
13	disabled	disabled	disabled	disabled	disabled	disabled	disabled	disabled	disabled
14	disabled	disabled	disabled	disabled	disabled	disabled	disabled	disabled	disabled
15	disabled	disabled	disabled	disabled	disabled	disabled	disabled	disabled	disabled

**Parameters description:**

Port	The logical port for the settings contained in the same row. Click on the port number in order to configure the shapers.
Shapers (Q0- Qn)	Shows "disabled" or actual queue shaper rate - e.g. "800 Mbps".
Port	Shows "disabled" or actual port shaper rate - e.g. "800 Mbps".

## 2.3.60 QoS – Tag Remarking

**Function name:**

QoS – Tag Remarking

**Function description:**

The function is used to provide user to get an overview of QoS Egress Port Tag Remarking for all switch ports. Others ports belong to the currently selected stack unit, as reflected by the page header.

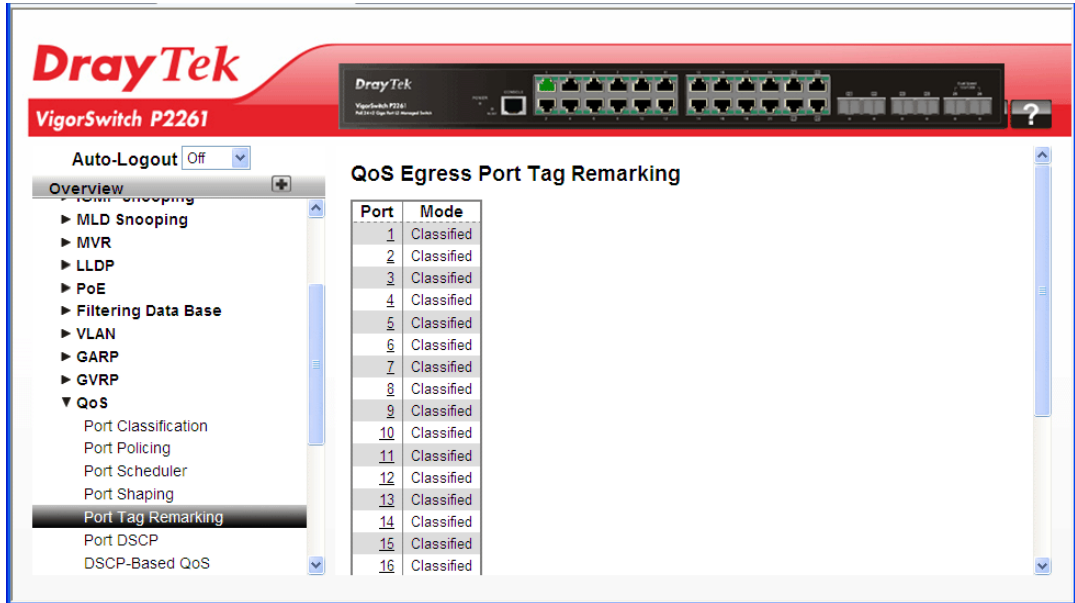

**Parameters description:**

Port	The logical port for the settings contained in the same row. Click on the port number in order to configure tag remarking.
Mode	Shows the tag remarking mode for this port. Classified: Use classified PCP/DEI values. Default: Use default PCP/DEI values. Mapped: Use mapped versions of QoS class and DP level.

## 2.3.61 QoS – DSCP

**Function name:**

QoS – DSCP

**Function description:**

The function is used to set the QoS Port DSCP configuration for the basic QoS Port DSCP Configuration settings for all switch ports.

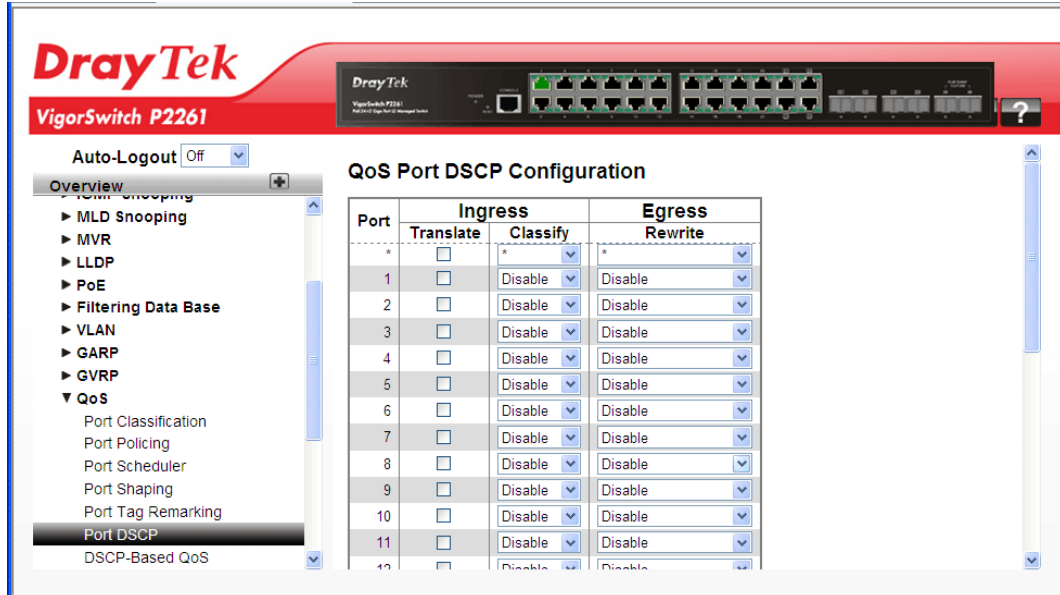

**Parameters description:**

Port	The Port column shows the list of ports for which you can configure DSCP ingress and egress settings.
Ingress	<p>In Ingress settings you can change ingress translation and classification settings for individual ports.</p> <p>There are two configuration parameters available in Ingress:</p> <ol style="list-style-type: none"> <li>1. Translate - Enable the Ingress Translation click the checkbox.</li> <li>2. Classify - Classification for a port have 4 different values. <ul style="list-style-type: none"> <li>● Disable: No Ingress DSCP Classification.</li> <li>● DSCP=0: Classify if incoming (or translated if enabled) DSCP is 0.</li> <li>● Selected: Classify only selected DSCP for which classification is enabled as specified in DSCP Translation window for the specific DSCP.</li> <li>● All: Classify all DSCP.</li> </ul> </li> </ol>
Egress	Port Egress Rewriting can be one of the following:

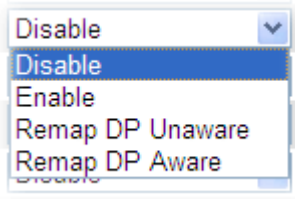

1. Disable: No Egress rewrite.
2. Enable: Rewrite enable without remapped.
3. Remap: DSCP from analyzer is remapped and frame is remarked with remapped DSCP value.

After finished the above settings, click **Apply** to save the configuration. The settings will take effect.

### 2.3.62 QoS – DSCP-Based QoS

**Function name:**

QoS – DSCP-Based QoS

**Function description:**

The function is used to configure the DSCP-Based QoS mode for the basic QoS DSCP-based QoS Ingress Classification settings for all switches.

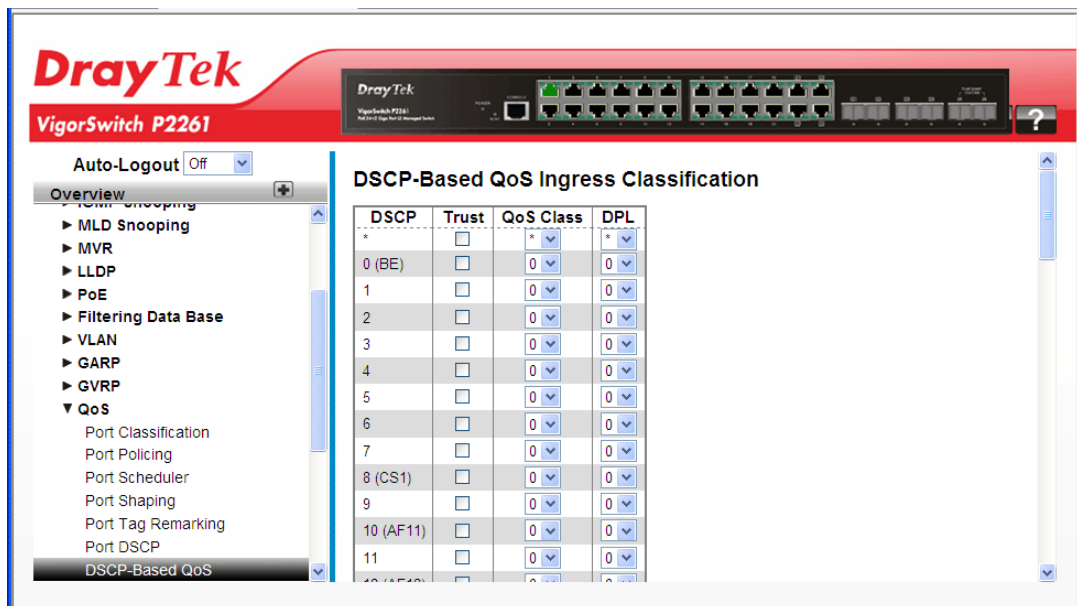

**Parameters description:**

DSCP	Maximum number of support ed DSCP values are 64.
Trust	Click to check if the DSCP value is trusted.
QoS Class	QoS Class value can be any of (0-7).
DPL	Drop Precedence Level (0-3).

After finished the above settings, click **Apply** to save the configuration. The settings will take effect.

## 2.3.63 QoS – DSCP Translation

**Function name:**

QoS – DSCP Translation

**Function description:**

The function is used to configure the basic QoS DSCP Translation settings for all switches. DSCP translation can be done in Ingress or Egress.

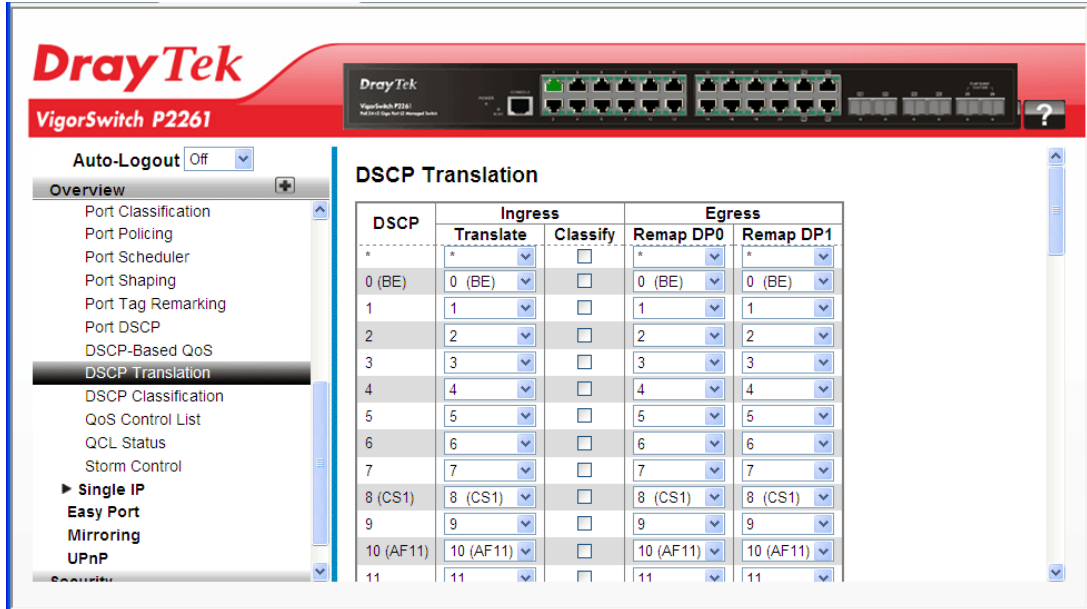

**Parameters description:**

DSCP	Maximum number of supported DSCP value is 64 and valid DSCP value ranges from 0 to 63.
Ingress	<p>Ingress side DSCP can be first translated to new DSCP before using the DSCP for QoS class and DPL map.</p> <p>There are two configuration parameters for DSCP Translation</p> <ol style="list-style-type: none"> <li>1. Translate - DSCP at Ingress side can be translated to any of (0-63) DSCP values.</li> <li>2. Classify - Click to enable Classification at Ingress side.</li> </ol>
Egress	<p>There are following configurable parameters for Egress side.</p> <ol style="list-style-type: none"> <li>1. Remap DP0 - Select the DSCP value from select menu to which you want to remap. DSCP value ranges form 0 to 63.</li> <li>2. Remap DP1 - Select the DSCP value from select menu to which you want to remap. DSCP value ranges form 0 to 63.</li> </ol>

After finished the above settings, click **Apply** to save the configuration. The settings will take effect.

## 2.3.64 QoS – DSCP Classification

**Function name:**

QoS – DSCP Classification

**Function description:**

The function is used to configure and allows you to map DSCP value to a QoS Class and DPL value.

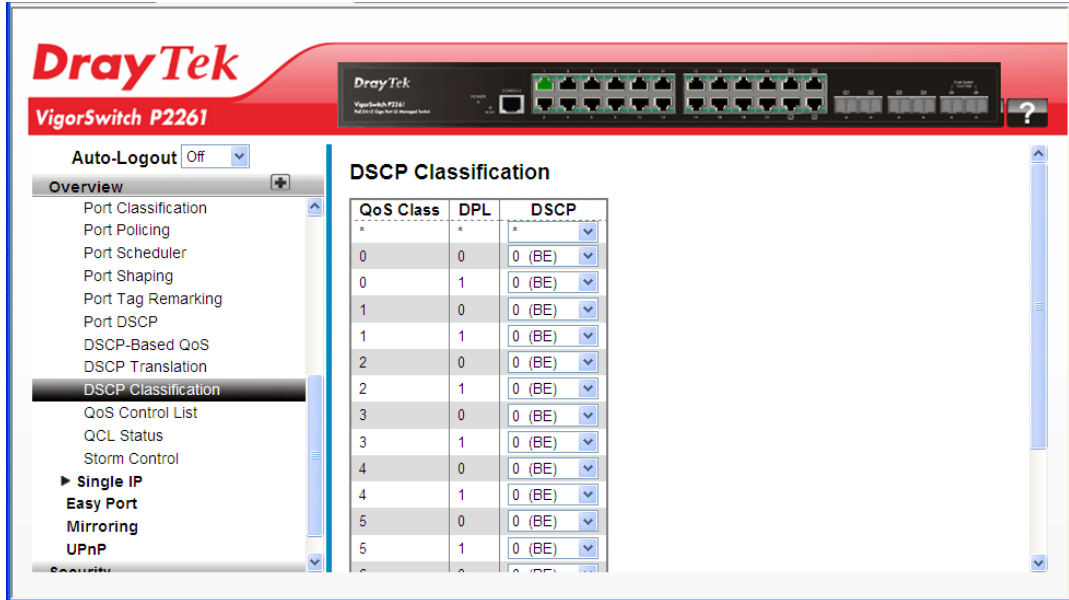

**Parameters description:**

QoS Class	Available QoS Class value ranges from 0 to 7. QoS Class (0-7) can be mapped to followed parameters.
DPL	Drop Precedence Level (0-1) can be configured for all available QoS Classes.
DSCP	Select DSCP value (0-63) from DSCP menu to map DSCP to corresponding QoS Class and DPL value.

After finished the above settings, click **Apply** to save the configuration. The settings will take effect.

### 2.3.65 QoS – QoS Control List

**Function name:**

QoS – QoS Control List

**Function description:**

The function shows the QoS Control List (QCL), which is made up of the QCEs. Each row describes a QCE that is defined. The maximum number of QCEs is 256 on each switch. Click on the lowest plus sign to add a new QCE to the list.

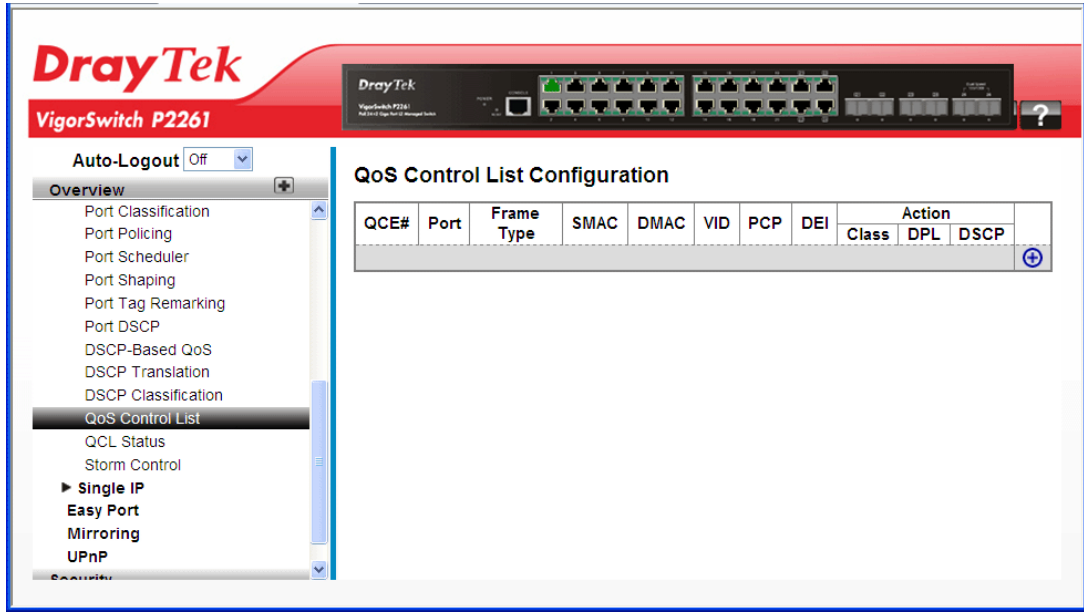

**Parameters description:**

QCE#	Indicates the index of QCE.
Port	Indicates the list of ports configured with the QCE.
Frame Type	Indicates the type of frame to look for incoming frames. Possible frame types are: Any: The QCE will match all frame type. Ethernet: Only Ethernet frames (with Ether Type 0x600-0xFFFF) are allowed. LLC: Only (LLC) frames are allowed. LLC: Only (SNAP) frames are allowed. IPv4: The QCE will match only IPV4 frames. IPv6: The QCE will match only IPV6 frames.
SMAC	Displays the OUI field of Source MAC address, i.e. first three octet (byte) of MAC address.
DMAC	Specify the type of Destination MAC addresses for incoming frame. Possible values are: Any: All types of Destination MAC addresses are allowed. Unicast: Only Unicast MAC addresses are allowed. Multicast: Only Multicast MAC addresses are allowed. Broadcast: Only Broadcast MAC addresses are allowed. The default value is 'Any'.

VID	Indicates (VLAN ID), either a specific VID or range of VIDs. VID can be in the range 1-4095 or 'Any'.
PCP	It means Priority Code Point. Valid value of PCP are specific (0, 1, 2, 3, 4, 5, 6, 7) or range (0-1, 2-3, 4-5, 6-7, 0-3, 4-7) or 'Any'.
DEI	It means Drop Eligible Indicator. Valid value of DEI can be any of values between 0, 1 or 'Any'.
Action	Indicates the classification action taken on ingress frame if parameters configured are matched with the frame's content. There are three action fields: Class, DPL and DSCP. Class: Classified QoS Class; if a frame matches the QCE it will be put in the queue. DPL: Drop Precedence Level; if a frame matches the QCE then DP level will set to value displayed under DPL column. DSCP: If a frame matches the QCE then DSCP will be classified with the value displayed under DSCP column.

Click the  to open the following page for adding a new QCE (QoS Control Entry).

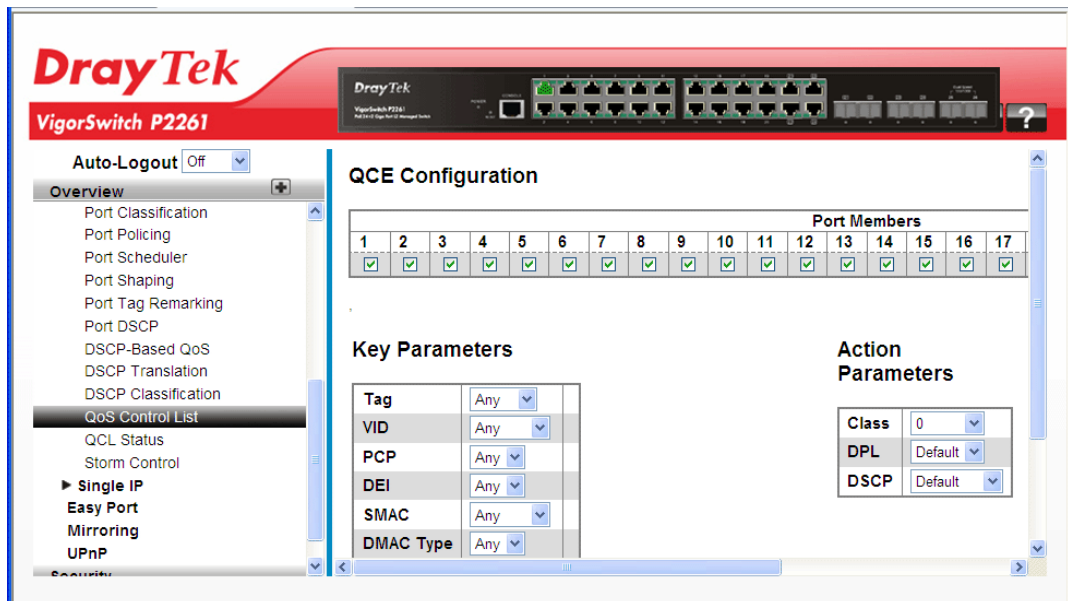







**Parameters description:**

Port Members	Check the checkbox button in case you want to make any port member of the QCL entry. By default all ports will be checked
Key Parameters	Key configuration are described as below: Tag - Value of Tag field can be 'Any', 'Untag' or 'Tag'. VID - Valid value of VLAN ID can be any value in the range 1-4094 or 'Any'; user can enter either a specific value or a range of VIDs. PCP - Priority Code Point: Valid value PCP are specific(0, 1, 2, 3, 4, 5, 6, 7) or range(0-1, 2-3, 4-5, 6-7, 0-3, 4-7) or



	<p>'Any'</p> <p>DEI - Drop Eligible Indicator: Valid value of DEI can be any of values between 0, 1 or 'Any'.</p> <p>SMAC - Source MAC address: 24 MS bits (OUI) or 'Any'.</p> <p>DMAC Type - Destination MAC type: possible values are unicast(UC), multicast(MC), broadcast(BC) or 'Any'.</p> <p>Frame Type - Frame Type can have any of the following values:</p> <ol style="list-style-type: none"> <li>1. Any</li> <li>2. Ethernet</li> <li>3. LLC</li> <li>4. SNAP</li> <li>5. IPv4</li> <li>6. IPv6</li> </ol> <p><b>Note:</b> all frame types are explained below:</p> <ol style="list-style-type: none"> <li>1. Any - Allow all types of frames.</li> <li>2. Ethernet - Valid ethernet type can have value within 0x600-0xFFFF or 'Any', default value is 'Any'.</li> <li>3. LLC - Valid SSAP (Source Service Access Point) can vary from 0x00 to 0xFF or 'Any', the default value is 'Any'. Valid DSAP(Destination Service Access Point) can vary from 0x00 to 0xFF or 'Any', the default value is 'Any'. Valid Control Address can vary from 0x00 to 0xFF or 'Any', the default value is 'Any'.</li> <li>4. SNAP - Valid PID(a.k.a ethernet type) can have value within 0x00-0xFFFF or 'Any', default value is 'Any'</li> <li>5. IPv4 - IP protocol number: (0-255, TCP or UDP) or 'Any'. Specific Source IP address in value/mask format or 'Any'. IP and Mask are in the format x.y.z.w where x, y, z, and w are decimal numbers between 0 and 255. When Mask is converted to a 32-bit binary string and read from left to right, all bits following the first zero must also be zero. Diffserv Code Point value (DSCP): It can be specific value, range of value or 'Any'. DSCP values are in the range 0-63 including BE, CS1-CS7, EF or AF11-AF43. IPv4 frame fragmented option: yes no any. Sport Source TCP/UDP port:(0-65535) or 'Any', specific or port range applicable for IP protocol UDP/TCP. Dport Destination TCP/UDP port:(0-65535) or 'Any', specific or port range applicable for IP protocol UDP/TCP.</li> <li>6. IPv6 - IP protocol number: (0-255, TCP or UDP) or 'Any' IPv6 source address: (a.b.c.d) or 'Any', 32 LS bits. Diffserv Code Point value (DSCP): It can be specific value, range of value or 'Any'. DSCP values are in the range 0-63 including BE, CS1-CS7, EF or AF11-AF43. Sport Source TCP/UDP port: (0-65535) or 'Any', specific or port range applicable for IP protocol UDP/TCP. Dport Destination TCP/UDP port:(0-65535) or 'Any', specific or port range applicable for IP</li> </ol>
--	--

	protocol UDP/TCP
Action Parameters	<p>Indicates the classification action taken on ingress frame if parameters configured are matched with the frame's content. There are three action fields: Class, DPL and DSCP.</p> <p><b>Class:</b> Classified QoS Class; if a frame matches the QCE it will be put in the queue.</p> <p><b>DPL:</b> Classified Drop Precedence Level; if a frame matches the QCE then DP level will set to value displayed under DPL column.</p> <p><b>DSCP:</b> Classified DSCP value; If a frame matches the QCE then DSCP will be classified with the value displayed under DSCP column.</p>
Other buttons	<p>You can modify each QCE (QoS Control Entry) in the table using the following buttons:</p> <p>: Inserts a new QCE before the current row.</p> <p>: Edits the QCE.</p> <p>: Moves the QCE up the list.</p> <p>: Moves the QCE down the list.</p> <p>: Deletes the QCE.</p> <p>: The lowest plus sign adds a new entry at the bottom of the QCE listings.</p>

After finished the above settings, click **Apply** to save the configuration. The settings will take effect.

### 2.3.66 QoS – QoS Status

**Function name:**

QoS – QoS Status

**Function description:**

The function is used to configure and shows the QCL status by different QCL (QoS Control List) users. Each row describes the QCE that is defined. It is a conflict if a specific QCE (QoS Control Entry) is not applied to the hardware due to hardware limitations. The maximum number of QCEs is 256 on each switch.

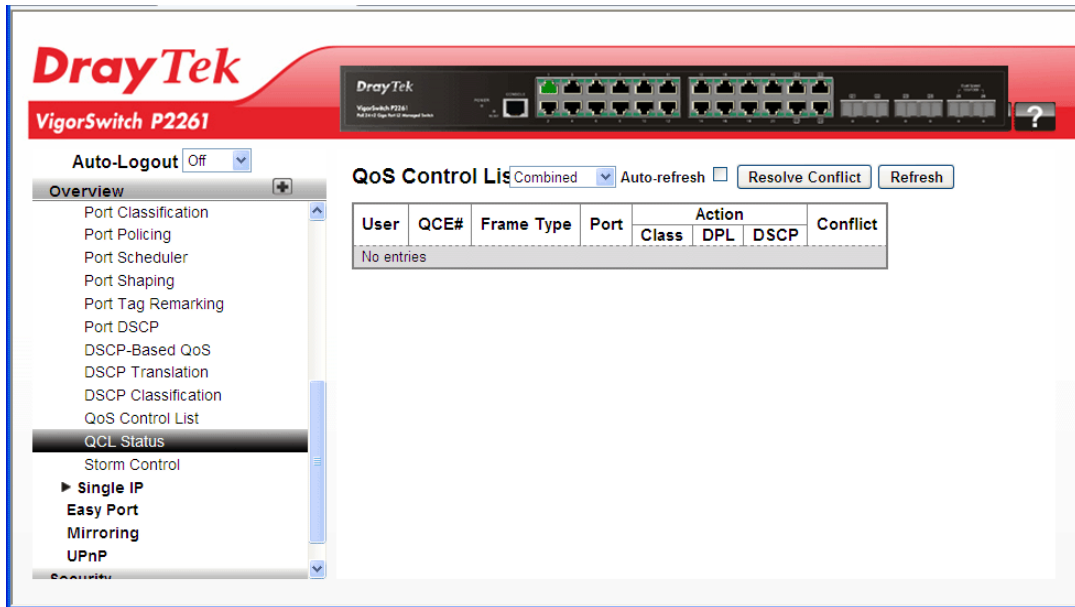

**Parameters description:**

	Select the QCL status from this drop down list.
User	Indicates the QCL user.
QCE#	Indicates the type of frame to look for incoming frames. Possible frame types are: Any: The QCE will match all frame type. Ethernet: Only Ethernet frames (with Ether Type 0x600-0xFFFF) are allowed. LLC: Only (LLC) frames are allowed. LLC: Only (SNAP) frames are allowed. IPv4: The QCE will match only IPV4 frames. IPv6: The QCE will match only IPV6 frames.
Port	Indicates the list of ports configured with the QCE.
Action	Indicates the classification action taken on ingress frame if parameters configured are matched with the frame's content. There are three action fields: Class, DPL and DSCP. Class: Classified QoS Class; if a frame matches the QCE it will be put in the queue. DPL: Drop Precedence Level; if a frame matches the QCE then DP level will set to value displayed under DPL column.

	DSCP: If a frame matches the QCE then DSCP will be classified with the value displayed under DSCP column.
Conflict	Displays QCE status. It may happen that resources required to add a QCE may not available, in that case it shows conflict status as 'Yes', otherwise it is always 'No'. Please note that conflict can be resolved by releasing the resource required by the QCE and pressing 'Refresh' button.
Auto refresh	Click to undo any changes made locally and revert to previously saved values.
Resolve Conflict	Click to release the resources required to add QCL entry, incase conflict status for any QCL entry is 'yes'.
Refresh	You can click them to refresh the QCL information by manual; any changes made locally will be undone.

After finished the above settings, click **Apply** to save the configuration. The settings will take effect.

### 2.3.67 QoS – Storm Control

**Function name:**

QoS – Storm Control

**Function description:**

The function is used to configure the Storm control for the switch. There is a unicast storm rate control, multicast storm rate control, and a broadcast storm rate control. These only affect flooded frames, i.e. frames with a (VLAN ID, DMAC) pair not present on the MAC Address table. The configuration indicates the permitted packet rate for unicast, multicast or broadcast traffic across the switch.

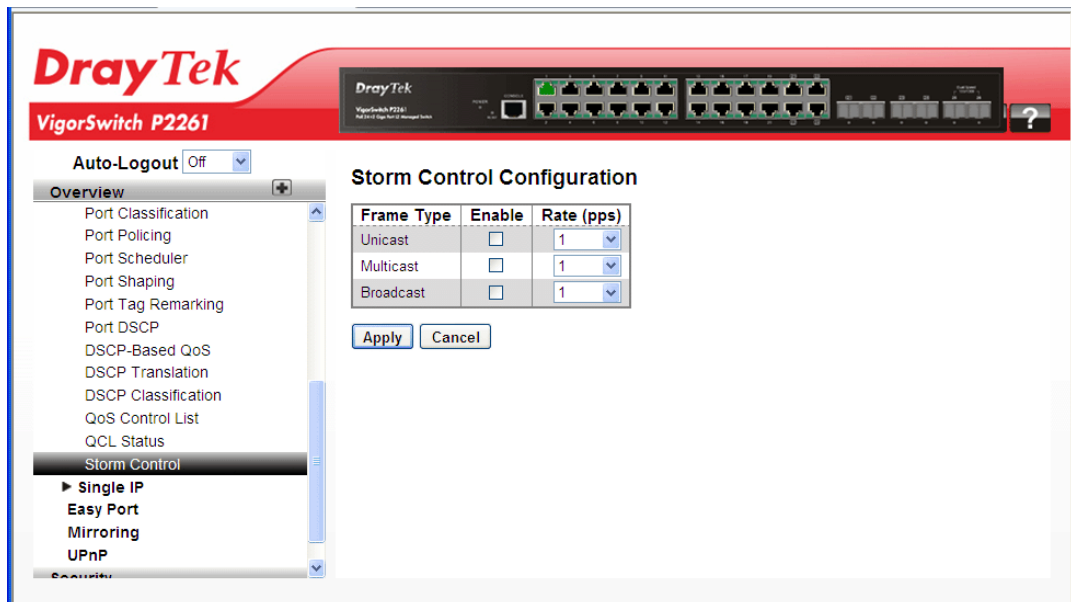

**Parameters description:**

Frame Type	The settings in a particular row apply to the frame type listed here: Unicast, Multicast or Broadcast.
------------	--

Enable	Enable or disable the storm control status for the given frame type.
Rate	The rate unit is packets per second (pps). Valid values are: 1, 2, 4, 8, 16, 32, 64, 128, 256, 512, 1K, 2K, 4K, 8K, 16K, 32K, 64K, 128K, 256K, 512K or 1024K. , 1024K, 2048K, 4096K, 8192K, 16384K or 32768K. , 1024K, 2048K, 4096K, 8192K, 16384K or 32768K. The 1 kpps is actually 1002.1 pps.

After finished the above settings, click **Apply** to save the configuration. The settings will take effect.

### 2.3.68 Single IP – General Setup

**Function name:**

Single IP – General Setup

**Function description:**

Single IP Management (SIM), a simple and useful method to optimize network utilities and management, is designed to manage a group of switches as a single entity, called an SIM group. Implementing the SIM feature will have the following advantages for users

- Simplify management of small workgroups or wiring closets while scaling networks to handle increased bandwidth demand.
- Reduce the number of IP addresses needed on the network.
- Virtual stacking structure - Eliminate any specialized cables for stacking and remove the distance barriers that typically limit topology options when using other stacking technology.

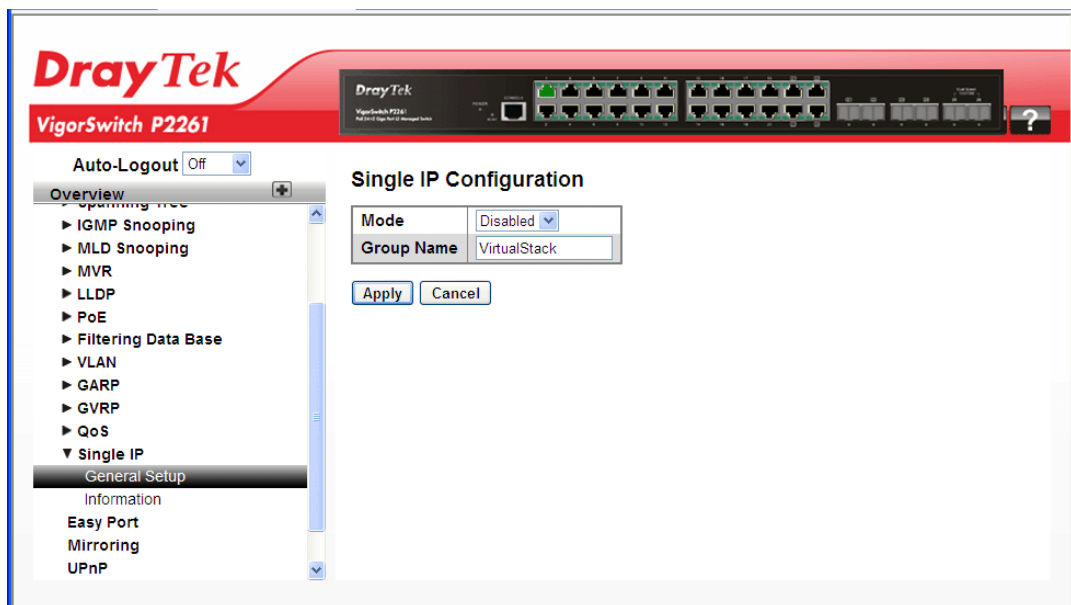

**Parameters description:**

Mode	The parameter lets you disable the SIP function or set the device become a Master role or Slave role. Possible modes are: <b>Disable:</b> Disable operation of Single IP Management.
------	---

	<p><b>Master:</b> Enable Single IP Management and to be a Master Switch. The role is root. User connects to the Master and can control the Slaves in the same SIP group.</p> <p><b>Slave:</b> Enable Single IP Management and to be a Slave Switch. The role is slave. User connects to the switch what is a slave via Master management GUI.</p>
Group Name	The parameter lets you set the name of the Single IP group. The available value up to 64 characters describing group name.

After finished the above settings, click **Apply** to save the configuration. The settings will take effect.

### 2.3.69 Single IP – Information

**Function name:**

Single IP – Information

**Function description:**

The function is to display the Single IP information what you set on the switch.

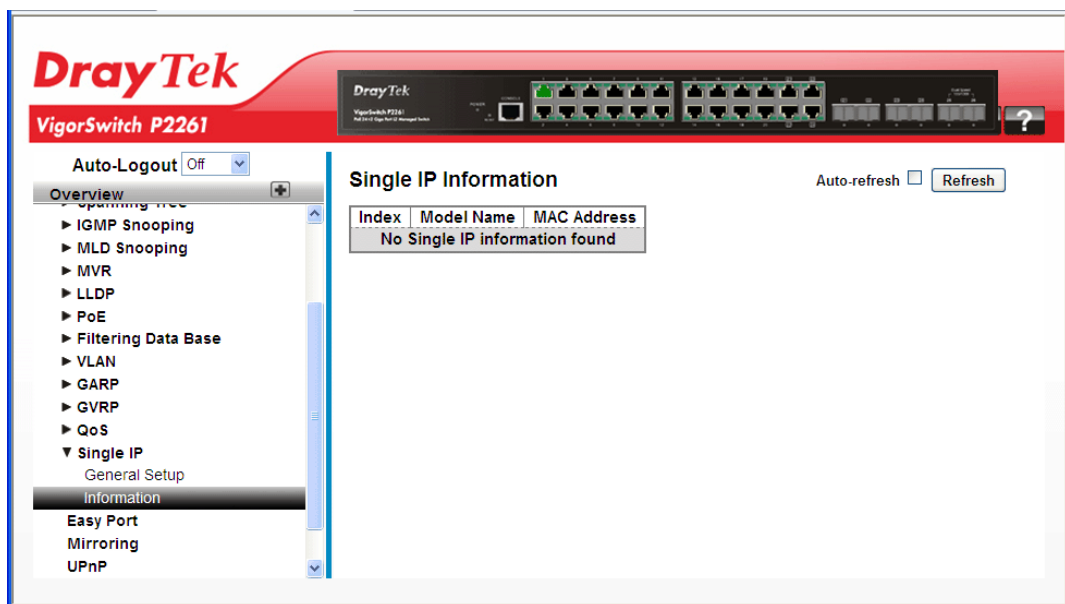

**Parameters description:**

Index	The ID of the active Slave Switch. The parameter lets you know how many slave devices connect to the SIP group.
Model Name	Display the model name of the Slave Switch. The parameter lets you to know what kind device join to this SIP group.
MAC Address	Display the Ethernet MAC address of the Slave Switch. The parameter lets you to know what device's MAC address and join to this SIP group.
Auto refresh	Check this box to enable an automatic refresh of the page at regular intervals.

Refresh

Click to refresh the page immediately.

## 2.3.70 Easy Port

### Function name:

Easy Port

### Function description:

The function is to provide a convenient way to save and share common configurations. You can use it to enable features and settings based on the location of a switch in the network and for mass configuration deployments across the network. You could easily implement included Voice IP phone, Wireless Access Point and IP Camera... etc. Others you can leverage configuration to run a converged voice, video, and data network considering quality of service (QoS), bandwidth, latency, and high performance.

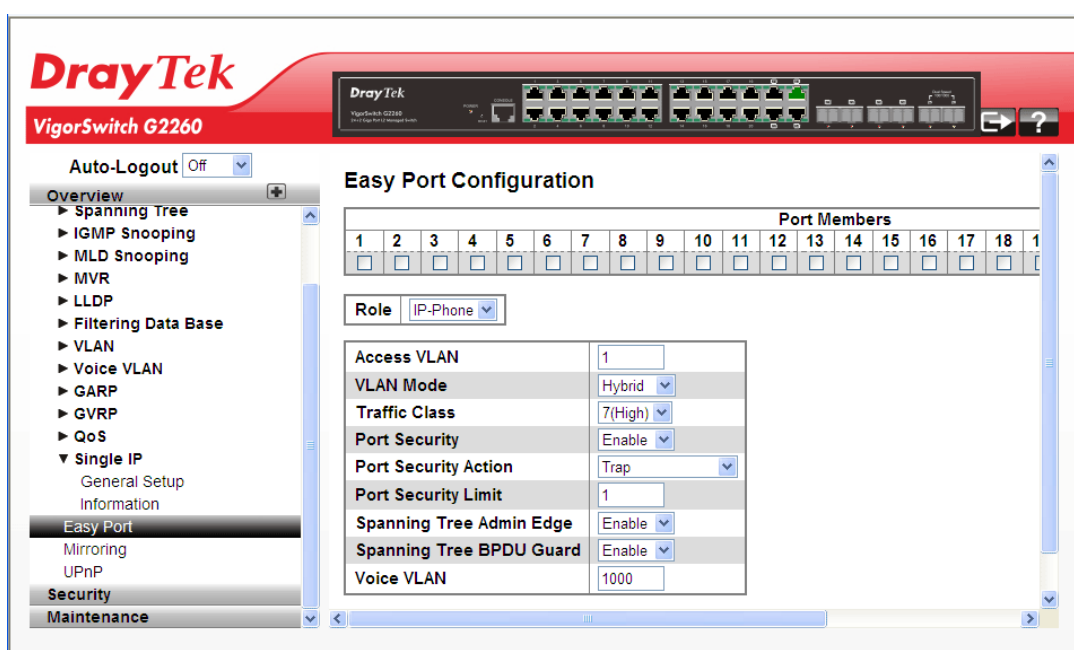

### Parameters description:

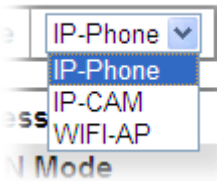
Port Members	A row of check boxes for each port is displayed for each VLAN ID. To include a port in a Easy Port, check the box as <input checked="" type="checkbox"/> . Remove or exclude the port from the VLAN, make sure the box is unchecked as shown as <input type="checkbox"/> . By default, no ports are members.
Role	The port role is based on the type of devices to be connected to the switch ports. To scroll to select what kind device you want to connect and implement with the Easy Port setting. 

Access VLAN	It is used to set the Access VLAN ID. It means the switch port access VLAN ID (AVID). The allowed range is from 1 to 4095.
VLAN Mode	It is used to scroll to select the Port Egress Rule. The allowed values are <b>Hybrid</b> , <b>Trunk</b> or <b>Access</b> . This parameter affects VLAN egress processing. If Trunk is selected, a VLAN tag with the classified VLAN ID is inserted in frames transmitted on the port. This mode is normally used for ports connected to VLAN aware switches. If Hybrid (the default value) is selected, if the classified VLAN ID of a frame transmitted on the port is different from the Port VLAN ID, a VLAN tag with the classified VLAN ID is inserted in the frame. If Access is selected, untag all frames transmitted on the port.
Traffic Class	It is used to scroll to select the traffic class for the data stream priority. The available value from 0 (Low) to 7 (High). If you want the voice has high priority then you can set the value with 7.
Port Security	It is used to scroll to enable or disable the Port Security function on the Port. If you turn on the function then you need to set Port Security limit to allow how many device can access the port (via MAC address).
Port Security Action	It is used to scroll to select when the device wasn't allow to access then switch action as trap, shutdown or trap & shutdown.
Port Security Limit	It is used to set the Port security limit, the default is 1.
Spanning Tree Admin Edge	It is used to scroll to enable or disable the Spanning Tree Admin Edge function on the Easy Port.
Spanning Tree BPDU Guard	It is used to scroll to enable or disable the Spanning Tree BPDU Guard function on the Easy Port.
Voice VLAN	If you connect the IP Phone, you need to assign the Voice VLAN ID. The value of the port number has to be typed into the text box.

After finished the above settings, click **Apply** to save the configuration. The settings will take effect.



## 2.3.71 Mirroring

You can mirror traffic from any source port to a target port for real-time analysis. You can then attach a logic analyzer or RMON probe to the target port and study the traffic crossing the source port in a completely unobtrusive manner.

### Function name:

Mirroring

### Function description:

The function is used to monitor the traffic of the network. For example, we assume that Port A and Port B are Monitoring Port and Monitored Port respectively, thus, the traffic received by Port B will be copied to Port A for monitoring.

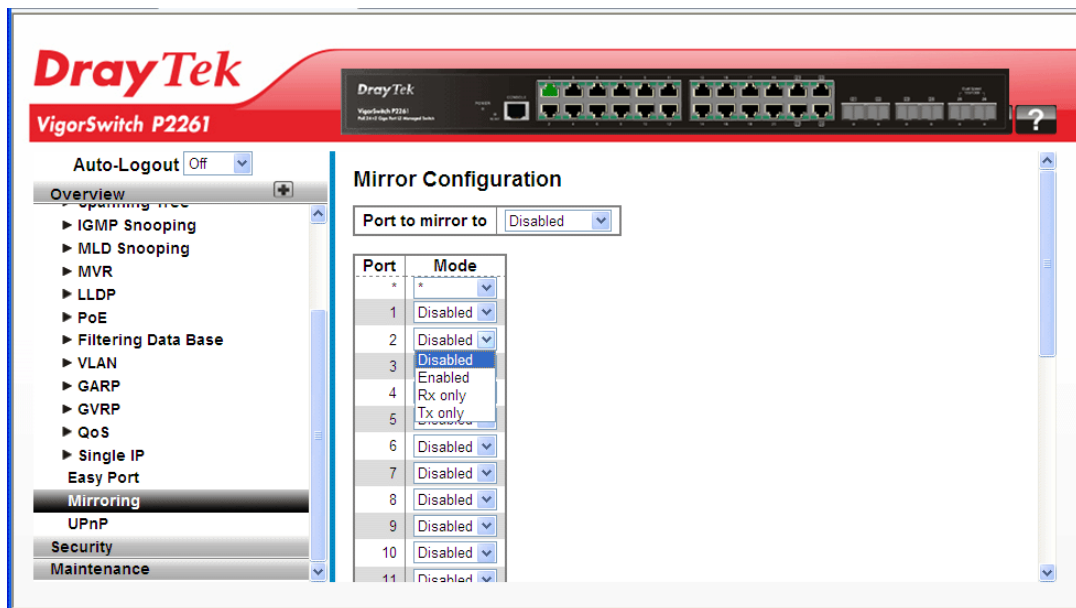

### Parameters description:

Port to mirror to	Port to mirror also known as the mirror port. Frames from ports that have either source (rx) or destination (tx) mirroring enabled are mirrored on this port. Disabled disables mirroring.
Port	The logical port for the settings contained in the same row.
Mode	<p>Select mirror mode.</p> <p>Rx only Frames received on this port are mirrored on the mirror port. Frames transmitted are not mirrored.</p> <p>Tx only Frames transmitted on this port are mirrored on the mirror port. Frames received are not mirrored.</p> <p>Disabled Neither frames transmitted nor frames received are mirrored.</p> <p>Enabled Frames received and frames transmitted are mirrored on the mirror port.</p> <p><b>Note:</b> For a given port, a frame is only transmitted once. It is therefore not possible to mirror Tx frames on the mirror port. Because of this, mode for the selected mirror port is limited to Disabled or Rx only.</p>

After finished the above settings, click **Apply** to save the configuration. The settings will take effect.

### 2.3.72 UPnP

**Function name:**

UPnP

**Function description:**

The function is used to allow devices to connect seamlessly and to simplify the implementation of networks in the home (data sharing, communications, and entertainment) and in corporate environments for simplified installation of computer components.

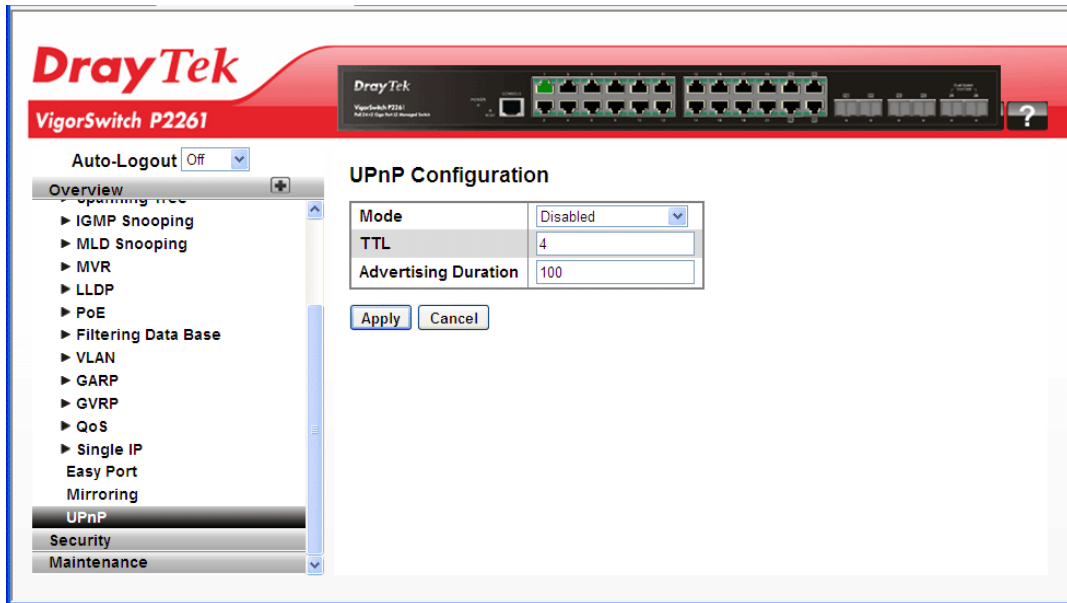

**Parameters description:**

Mode	Indicate the UPnP operation mode. Possible modes are: <b>Enabled:</b> Enable UPnP mode operation. <b>Disabled:</b> Disable UPnP mode operation. When the mode is enabled, two ACEs are added automatically to trap UPnP related packets to CPU. The ACEs are automatically removed when the mode is disabled.
TTL	The TTL value is used by UPnP to send SSDP advertisement messages. Valid values are in the range 1 to 255.
Advertising Duration	The duration, carried in SSDP packets, is used to inform a control point or control points how often it or they should receive an SSDP advertisement message from this switch. If a control point does not receive any message within the duration, it will think that the switch no longer exists. Due to the unreliable nature of UDP, in the standard it is recommended that such refreshing of advertisements to be done at less than one-half of the advertising duration. In the implementation, the switch sends SSDP messages periodically at the interval one-half of the advertising duration minus 30 seconds. Valid values are in the range

	100 to 86400.
Apply	Click to save changes.
Reset	Click to undo any changes made locally and revert to previously saved values.

After finished the above settings, click **Apply** to save the configuration. The settings will take effect.

## 2.4 Security

### 2.4.1 ACL - Ports

The switch access control list (ACL) is probably the most commonly used object in the IOS. It is used for packet filtering but also for selecting types of traffic to be analyzed, forwarded, or influenced in some way. The ACLs are divided into EtherTypes, IPv4, ARP protocol, MAC and VLAN parameters, and etc. Here we will just go over the standard and extended access lists for TCP/IP. As you create ACEs for ingress classification, you can assign a policy for each port. The policy number is 1-8, however, each policy can be applied to any port. This makes it very easy to determine what type of ACL policy you will be working with.

**Function name:**

ACL - Ports

**Function description:**

The function is used to configure the ACL parameters (ACE) of the each switch port. These parameters will affect frames received on a port unless the frame matches a specific ACE.

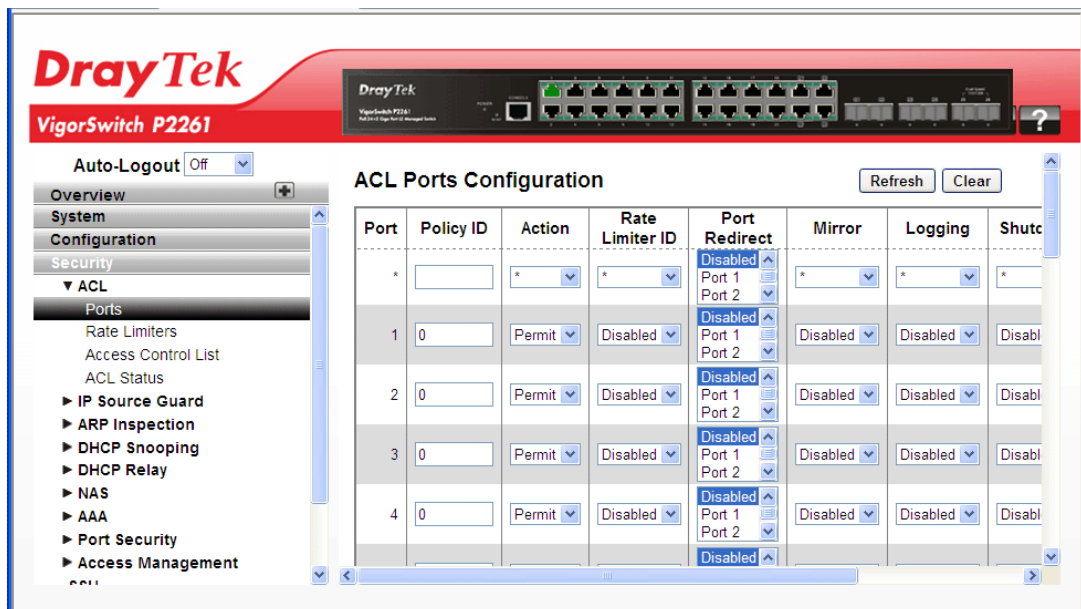

**Parameters description:**

Port	The logical port for the settings contained in the same row.
Policy ID	Select the policy to apply to this port. The allowed values are 1 through 8. The default value is 1.
Action	Select whether forwarding is permitted ("Permit") or denied

	("Deny"). The default value is "Permit".
Rate Limiter ID	Select which rate limiter to apply on this port. The allowed values are Disabled or the values 1 through 16. The default value is "Disabled".
Port Redirect	Select which port frames are copied on. The allowed values are Disabled or a specific port number. The default value is "Disabled".
Mirror	Specify the mirror operation of this port. The allowed values are: Enabled: Frames received on the port are mirrored. Disabled: Frames received on the port are not mirrored. The default value is "Disabled".
Logging	Specify the logging operation of this port. The allowed values are: Enabled: Frames received on the port are stored in the System Log. Disabled: Frames received on the port are not logged. The default value is "Disabled". Please note that the System Log memory size and logging rate is limited.
Shutdown	Specify the port shut down operation of this port. The allowed values are: Enabled: If a frame is received on the port, the port will be disabled. Disabled: Port shut down is disabled. The default value is "Disabled".
<b>State</b>	Specify the port state of this port. The allowed values are: <b>Enabled:</b> To reopen ports by changing the volatile port configuration of the ACL user module. <b>Disabled:</b> To close ports by changing the volatile port configuration of the ACL user module. The default value is "Enabled".
Counter	Counts the number of frames that match this ACE.
Refresh	The simple counts will be refreshed manually when user use mouse to click on "Refresh" button.
Clear	The simple counts will be reset to zero when user use mouse to click on "Clear" button.

After finished the above settings, click **Apply** to save the configuration. The settings will take effect.

## 2.4.2 ACL – Rate Limiters

### Function name:

ACL – Rate Limiters

### Function description:

The function is used to configure the switch's ACL Rate Limiter parameters. The Rate Limiter Level from 1 to 16 that allow user to set rate limiter value and units with *pps* or *kbps*.

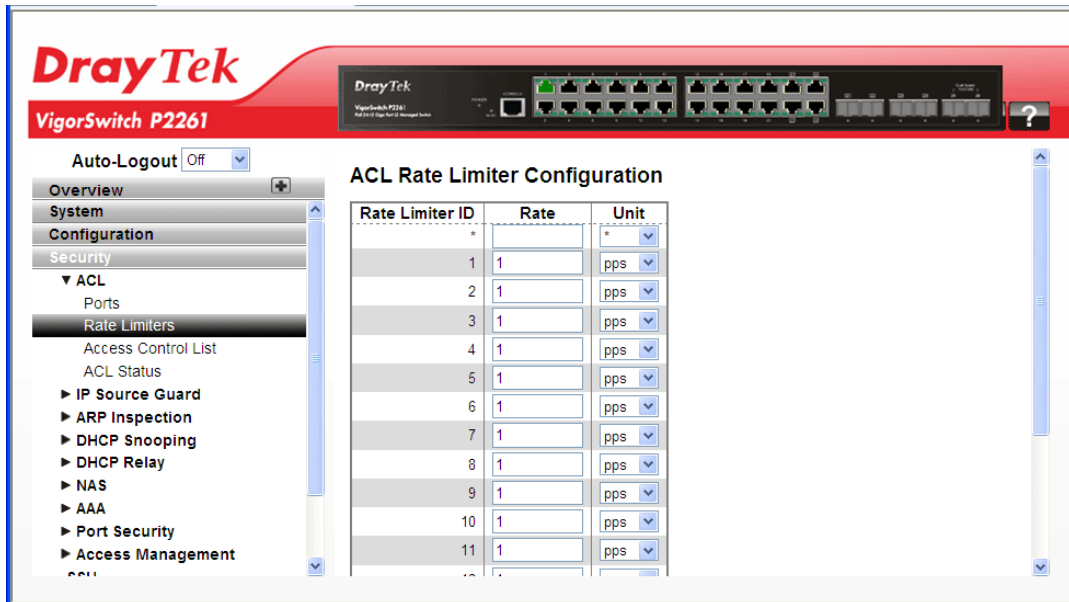

### Parameters description:

Rate Limiter ID	The rate limiter ID for the settings contained in the same row.
Rate	The rate unit is packets per second (pps), configure the rate as 1, 2, 4, ..., 512, 1K, 2K, 4K, ..., 3276700k. The 1 kpps is actually 1002.1 pps. The allowed values are: 0-3276700 in pps or 0, 100, 200, 300, ..., 1000000 in kbps.
Unit	Specify the rate unit. The allowed values are: pps: Packets per second. kbps: Kbits per second.

After finished the above settings, click **Apply** to save the configuration. The settings will take effect.

## 2.4.3 ACL – Access Control List

The section describes how to configure Access Control List rule. An Access Control List (ACL) is a sequential list of permit or deny conditions that apply to IP addresses, MAC addresses, or other more specific criteria. This switch tests ingress packets against the conditions in an ACL one by one. A packet will be accepted as soon as it matches a permit rule, or dropped as soon as it matches a deny rule. If no rules match, the frame is accepted. Other actions can also be invoked when a matching packet is found, including rate limiting, copying matching packets to another port or to the system log, or shutting down a port.

### Function name:

ACL – Access Control List

### Function description:

The function is used to show the Access Control List (ACL), which is made up of the ACEs defined on this switch. Each row describes the ACE that is defined. The maximum number of ACEs is 256 on each switch. Click on the lowest plus sign to add a new ACE to the list. The reserved ACEs used for internal protocol, cannot be edited or deleted, the order sequence cannot be changed and the priority is highest

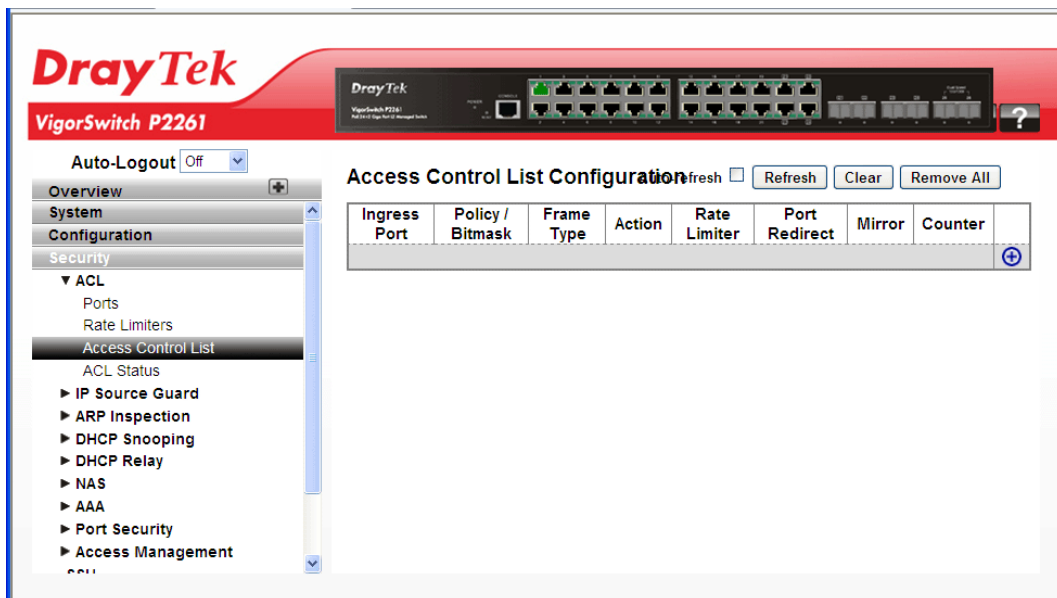

### Parameters description:

Ingress Port	Indicates the ingress port of the ACE. Possible values are: Any: The ACE will match any ingress port. Policy: The ACE will match ingress ports with a specific policy. Port: The ACE will match a specific ingress port.
Policy/Bitmask	Indicates the policy number and bitmask of the ACE.
Frame Type	Indicates the frame type of the ACE. Possible values are: Any: The ACE will match any frame type. EType: The ACE will match Ethernet Type frames. Note that an Ethernet Type based ACE will not get matched by IP and ARP frames. ARP: The ACE will match ARP/RARP frames. IPv4: The ACE will match all IPv4 frames.

	<p>IPv4/ICMP: The ACE will match IPv4 frames with ICMP protocol.</p> <p>IPv4/UDP: The ACE will match IPv4 frames with UDP protocol.</p> <p>IPv4/TCP: The ACE will match IPv4 frames with TCP protocol.</p> <p>IPv4/Other: The ACE will match IPv4 frames, which are not ICMP/UDP/TCP.</p> <p>IPv6: The ACE will match all IPv6 standard frames.</p>
Action	<p>Indicates the forwarding action of the ACE.</p> <p>Permit: Frames matching the ACE may be forwarded and learned.</p> <p>Deny: Frames matching the ACE are dropped.</p>
Rate Limiter	<p>Indicates the rate limiter number of the ACE. The allowed range is 1 to 16. When Disabled is displayed, the rate limiter operation is disabled.</p>
<b>Port Redirect</b>	<p>Indicates the port redirect operation of the ACE. Frames matching the ACE are copied to the port number. The allowed values are Disabled or a specific port number. When Disabled is displayed, the port copy operation is disabled.</p>
Mirror	<p>Specify the mirror operation of this port. The allowed values are:</p> <p>Enabled: Frames received on the port are mirrored.</p> <p>Disabled: Frames received on the port are not mirrored.</p> <p>The default value is "Disabled".</p>
Counter	<p>The counter indicates the number of times the ACE was hit by a frame.</p>
Auto refresh	<p>The simple counts will be refreshed automatically on the UI screen.</p>
Refresh	<p>The simple counts will be refreshed manually when user use mouse to click on "Refresh" button.</p>
Clear	<p>The simple counts will be reset to zero when user use mouse to click on "Clear" button.</p>
Remove All	<p>Clean up all ACL configurations on the table.</p>

Click the  button to add a new ACL, or use the other ACL modification buttons to specify the editing action (i.e., edit, delete, or moving the relative position of entry in the list).

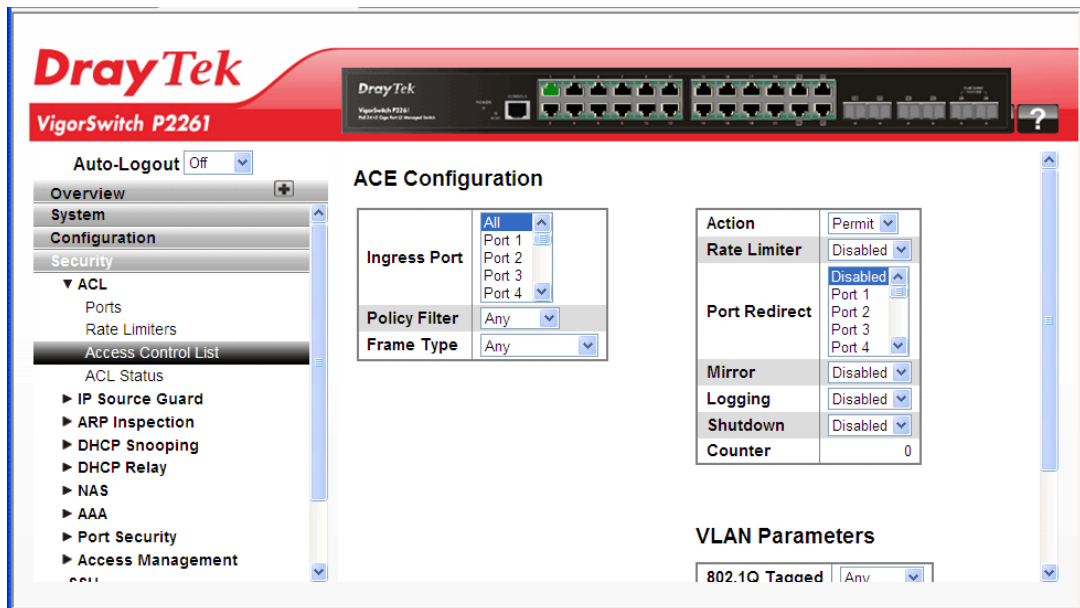

### Parameters description:

ACE Configuration	
Ingress Port	<p>Indicates the ingress port of the ACE. Possible values are:</p> <p><b>Any:</b> The ACE will match any ingress port.</p> <p><b>Policy:</b> The ACE will match ingress ports with a specific policy.</p> <p><b>Port:</b> The ACE will match a specific ingress port.</p>
Policy Filter	<p>Specify the policy number filter for this ACE.</p> <p><b>Any:</b> No policy filter is specified. (policy filter status is "don't-care".)</p> <p><b>Specific:</b> If you want to filter a specific policy with this ACE, choose this value. Two field for entering a policy value and bitmask appears.</p>
Frame Type	<p>Indicates the frame type of the ACE. Possible values are:</p> <p><b>Any:</b> The ACE will match any frame type.</p> <p><b>EType:</b> The ACE will match Ethernet Type frames. Note that an Ethernet Type based ACE will not get matched by IP and ARP frames.</p> <p><b>ARP:</b> The ACE will match ARP/RARP frames.</p> <p><b>IPv4:</b> The ACE will match all IPv4 frames.</p> <p><b>IPv4/ICMP:</b> The ACE will match IPv4 frames with ICMP protocol.</p> <p><b>IPv4/UDP:</b> The ACE will match IPv4 frames with UDP protocol.</p> <p><b>IPv4/TCP:</b> The ACE will match IPv4 frames with TCP protocol.</p>



	<p>IPv4/Other: The ACE will match IPv4 frames, which are not ICMP/UDP/TCP.</p> <p>IPv6: The ACE will match all IPv6 standard frames.</p>
Action	<p>Indicates the forwarding action of the ACE.</p> <p>Permit: Frames matching the ACE may be forwarded and learned.</p> <p>Deny: Frames matching the ACE are dropped.</p>
Rate Limiter	<p>Indicates the rate limiter number of the ACE. The allowed range is 1 to 16. When Disabled is displayed, the rate limiter operation is disabled.</p>
<b>Port Redirect</b>	<p>Indicates the port redirect operation of the ACE. Frames matching the ACE are copied to the port number. The allowed values are Disabled or a specific port number. When Disabled is displayed, the port copy operation is disabled.</p>
Mirror	<p>Specify the mirror operation of this port. The allowed values are:</p> <p>Enabled: Frames received on the port are mirrored.</p> <p>Disabled: Frames received on the port are not mirrored.</p> <p>The default value is "Disabled".</p>
Logging	<p>Indicates the logging operation of the ACE. Possible values are:</p> <p>Enabled: Frames matching the ACE are stored in the System Log.</p> <p>Disabled: Frames matching the ACE are not logged.</p> <p>Please note that the System Log memory size and logging rate is limited.</p>
Shutdown	<p>Indicates the port shut down operation of the ACE. Possible values are:</p> <p>Enabled: If a frame matches the ACE, the ingress port will be disabled.</p> <p>Disabled: Port shut down is disabled for the ACE.</p>
Counter	<p>The counter indicates the number of times the ACE was hit by a frame.</p>
<b>VLAN Parameters</b>	
<b>802.1Q Tagged</b>	<p>Specify whether frames can hit the action according to the 802.1Q tagged. The allowed values are:</p> <p><b>Any:</b> Any value is allowed ("don't-care").</p> <p><b>Enabled:</b> Tagged frame only.</p> <p><b>Disabled:</b> Untagged frame only.</p> <p>The default value is "Any".</p>
<b>VLAN ID Filter</b>	<p>Specify the VLAN ID filter for this ACE.</p> <p><b>Any:</b> No VLAN ID filter is specified. (VLAN ID filter</p>

	status is "don't-care".) <b>Specific:</b> If you want to filter a specific VLAN ID with this ACE, choose this value. A field for entering a VLAN ID number appears.
<b>Tag Priority</b>	Specify the tag priority for this ACE. A frame that hits this ACE matches this tag priority. The allowed number range is 0 to 7. The value Any means that no tag priority is specified (tag priority is "don't-care".)

After finished the above settings, click **Apply** to save the configuration. The settings will take effect.

## 2.4.4 ACL – ACL Status

**Function name:**

ACL – ACL Status

**Function description:**

The function is used to show the ACL status by different ACL users. Each row describes the ACE that is defined. It is a conflict if a specific ACE is not applied to the hardware due to hardware limitations. The maximum number of ACEs is 256 on each switch.

The screenshot shows the DrayTek VigorSwitch P2261 web interface. The left sidebar contains a navigation menu with 'ACL Status' selected. The main content area is titled 'ACL Status' and features a table with the following data:

User	Ingress Port	Frame Type	Action	Rate Limiter	Port Redirect	Mirror	CPU	CPU Once	Count
IP Management	All	ARP	Deny	Disabled	Disabled	Disabled	Yes	No	3
IP Management	All	IPv4/UDP 68 DHCP Server	Deny	Disabled	Disabled	Disabled	Yes	No	
Reserved	All	EType	Permit	Disabled	Disabled	Disabled	No	No	
Reserved	All	EType	Permit	Disabled	Disabled	Disabled	No	No	

**Parameters description:**

User	Indicates the ACL user.
Ingress Port	Indicates the ingress port of the ACE. Possible values are: Any: The ACE will match any ingress port. Policy: The ACE will match ingress ports with a specific policy. Port: The ACE will match a specific ingress port.
Frame Type	Indicates the frame type of the ACE. Possible values are: Any: The ACE will match any frame type. EType: The ACE will match Ethernet Type frames. Note that an Ethernet Type based ACE will not get matched by IP

	<p>and ARP frames.</p> <p>ARP: The ACE will match ARP/RARP frames.</p> <p>IPv4: The ACE will match all IPv4 frames.</p> <p>IPv4/ICMP: The ACE will match IPv4 frames with ICMP protocol.</p> <p>IPv4/UDP: The ACE will match IPv4 frames with UDP protocol.</p> <p>IPv4/TCP: The ACE will match IPv4 frames with TCP protocol.</p> <p>IPv4/Other: The ACE will match IPv4 frames, which are not ICMP/UDP/TCP.</p> <p>IPv6: The ACE will match all IPv6 standard frames.</p>
Action	<p>Indicates the forwarding action of the ACE.</p> <p>Permit: Frames matching the ACE may be forwarded and learned.</p> <p>Deny: Frames matching the ACE are dropped.</p>
Rate Limiter	<p>Indicates the rate limiter number of the ACE. The allowed range is 1 to 16. When Disabled is displayed, the rate limiter operation is disabled.</p>
Port Redirect	<p>Indicates the port redirect operation of the ACE. Frames matching the ACE are copied to the port number. The allowed values are Disabled or a specific port number. When Disabled is displayed, the port copy operation is disabled.</p>
Mirror	<p>Specify the mirror operation of this port. The allowed values are:</p> <p>Enabled: Frames received on the port are mirrored.</p> <p>Disabled: Frames received on the port are not mirrored.</p> <p>The default value is "Disabled".</p>
CPU	<p>Forward packet that matched the specific ACE to CPU.</p>
CPU Once	<p>Forward first packet that matched the specific ACE to CPU.</p>
Counter	<p>The counter indicates the number of times the ACE was hit by a frame.</p>
Conflict	<p>Indicates the hardware status of the specific ACE. The specific ACE is not applied to the hardware due to hardware limitations.</p>
Auto refresh	<p>The simple counts will be refreshed automatically on the UI screen.</p>
Refresh	<p>The simple counts will be refreshed manually when user use mouse to click on "Refresh" button.</p>

## 2.4.5 IP Source Guard – General Setup

### Function name:

IP Source Guard – General Setup

### Function description:

The function is used to configure the IP Source Guard detail parameters of the switch. You could use the IP Source Guard configure to enable or disable with the Port of the switch.

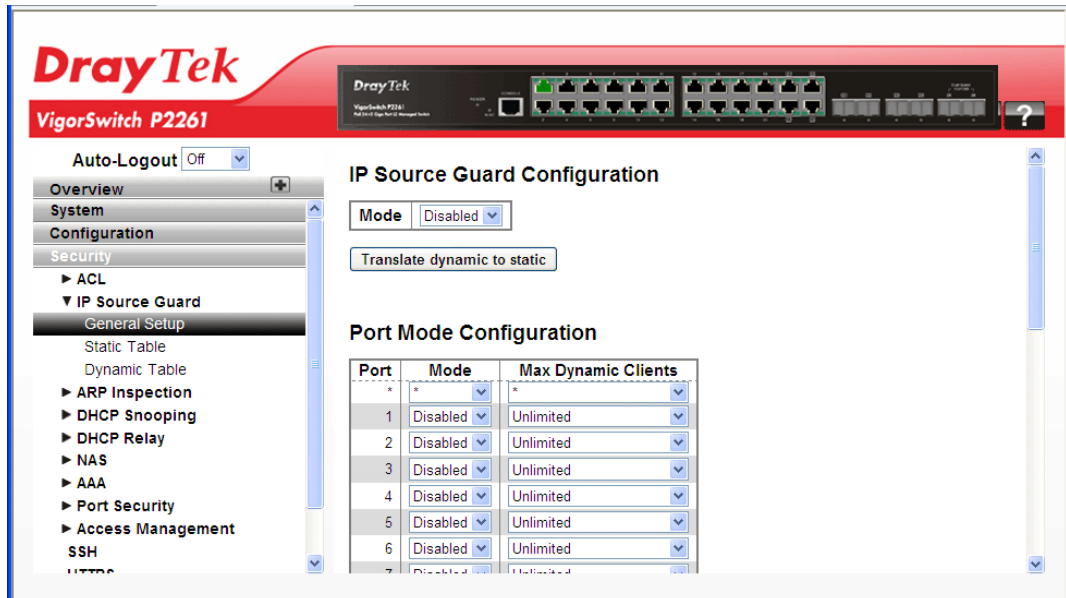

### Parameters description:

IP Source Guard Configuration	Mode - Enable the Global IP Source Guard or disable the Global IP Source Guard. All configured ACEs will be lost when the mode is enabled.
<b>Translate dynamic static</b>	Click to translate all dynamic entries to static entries.
Port Mode Configuration	Specify IP Source Guard is enabled on which ports. Only when both Global Mode and Port Mode on a given port are enabled, IP Source Guard is enabled on this given port. Max Dynamic Clients - Specify the maximum number of dynamic clients that can be learned on given port. This value can be 0, 1, 2 or unlimited. If the port mode is enabled and the value of max dynamic client is equal to 0, it means only allow the IP packets forwarding that are matched in static entries on the specific port.

After finished the above settings, click **Apply** to save the configuration. The settings will take effect.

## 2.4.6 IP Source Guard – Static Table

**Function name:**

IP Source Guard – Static Table

**Function description:**

The function is used to configure the Static IP Source Guard Table parameters of the switch. You could use the Static IP Source Guard Table configure to manage the entries.

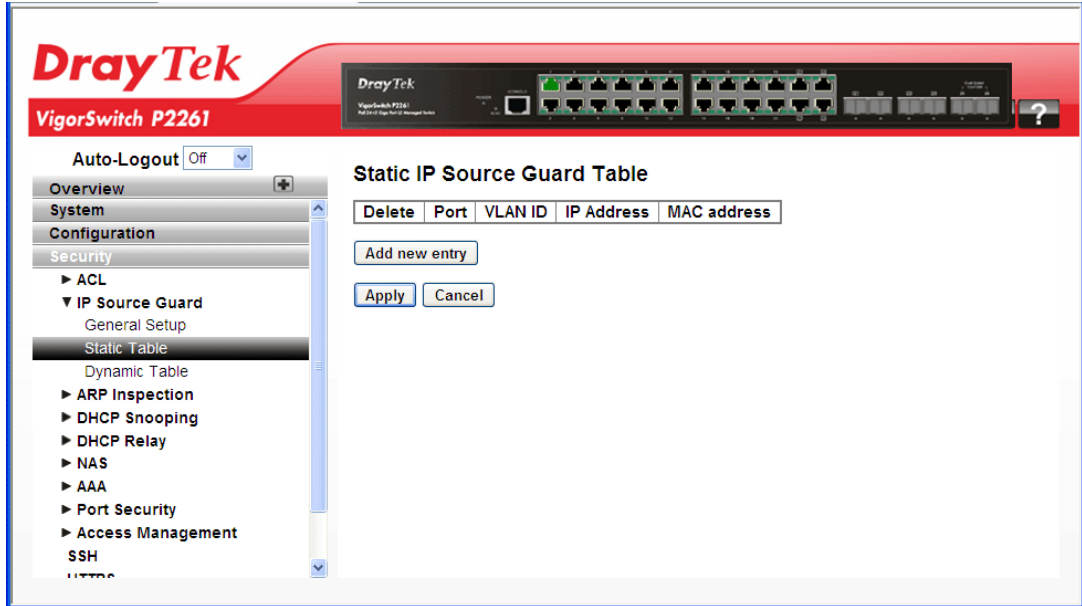

**Parameters description:**

Delete	Check to delete the entry.										
Port	The logical port for the settings.										
VLAN ID	The ID number for the settings.										
IP Address	Allowed Source IP address.										
MAC Address	Allowed Source MAC address.										
Adding new entry	<p>Click to add a new entry to the Static IP Source Guard table. Specify the Port, VLAN ID, IP address, and IP Mask for the new entry. Click Apply</p> <p><b>Static IP Source Guard Table</b></p> <table border="1"> <thead> <tr> <th>Delete</th> <th>Port</th> <th>VLAN ID</th> <th>IP Address</th> <th>MAC address</th> </tr> </thead> <tbody> <tr> <td>Delete</td> <td>1</td> <td></td> <td></td> <td></td> </tr> </tbody> </table> <p>Add new entry</p> <p>Apply Reset</p>	Delete	Port	VLAN ID	IP Address	MAC address	Delete	1			
Delete	Port	VLAN ID	IP Address	MAC address							
Delete	1										

After finished the above settings, click **Apply** to save the configuration. The settings will take effect.

## 2.4.7 IP Source Guard – Dynamic Table

**Function name:**

IP Source Guard – Dynamic Table

**Function description:**

The function is used to configure the Dynamic IP Source Guard Table parameters of the switch. You could use the Dynamic IP Source Guard Table configure to manage the entries.

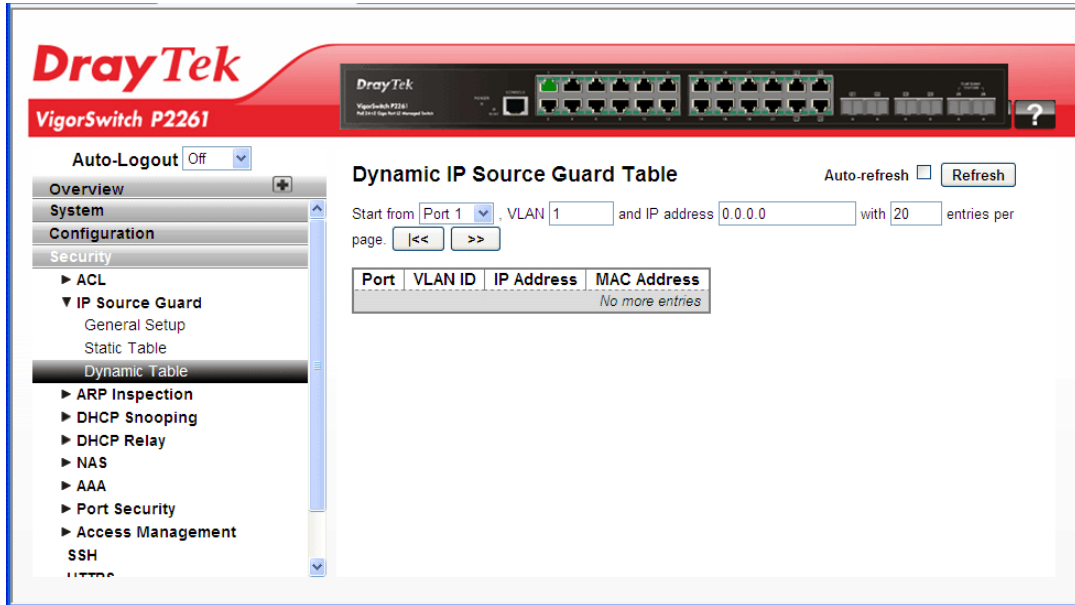

**Parameters description:**

Start from Port #	Switch Port Number for which the entries are displayed.
VLAN ID	VLAN-ID in which the IP traffic is permitted.
IP Address	User IP address of the entry.
MAC Address	Source MAC address.
Auto refresh	The simple counts will be refreshed automatically on the UI screen.
Refresh	The simple counts will be refreshed manually when user use mouse to click on “Refresh” button.

## 2.4.8 ARP Inspection – General Setup

**Function name:**

ARP Inspection – General Setup

**Function description:**

The function is used to configure the ARP Inspection parameters of the switch. You could use the ARP Inspection configure to manage the ARP table.

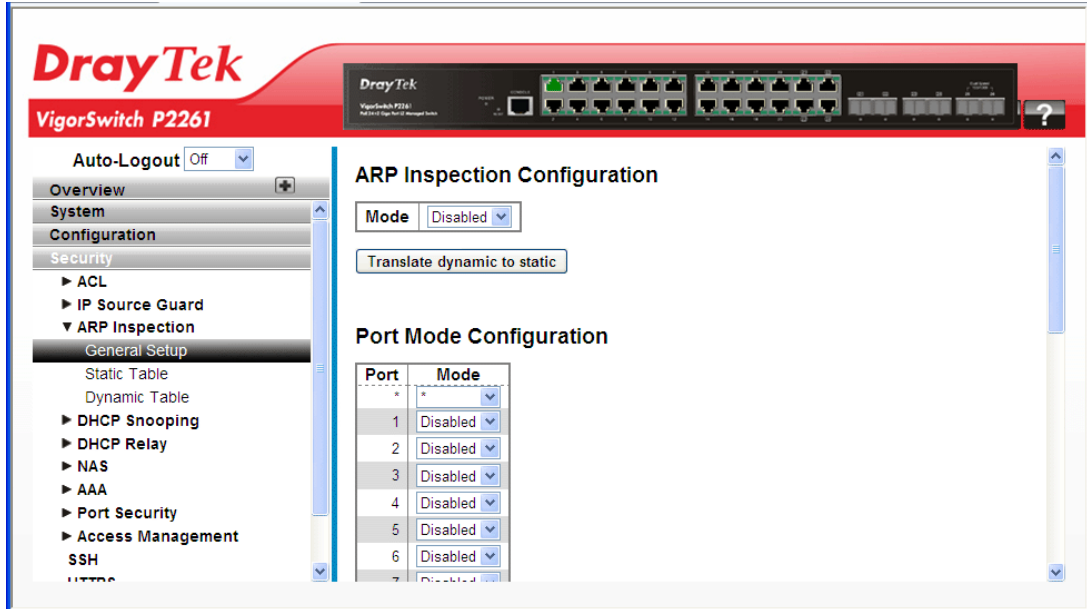

**Parameters description:**

ARP Inspection Configuration	Mode - Enable the Global ARP Inspection or disable the Global ARP Inspection.
<b>Translate dynamic static</b>	Click to translate all dynamic entries to static entries.
Port Mode Configuration	Specify ARP Inspection is enabled on which ports. Only when both Global Mode and Port Mode on a given port are enabled, ARP Inspection is enabled on this given port.

After finished the above settings, click **Apply** to save the configuration. The settings will take effect.

## 2.4.9 ARP Inspection – Static Table

**Function name:**

ARP Inspection – Static Table

**Function description:**

The function is used to configure the Static ARP Inspection Table parameters of the switch. You could use the Static ARP Inspection Table configure to manage the ARP entries.

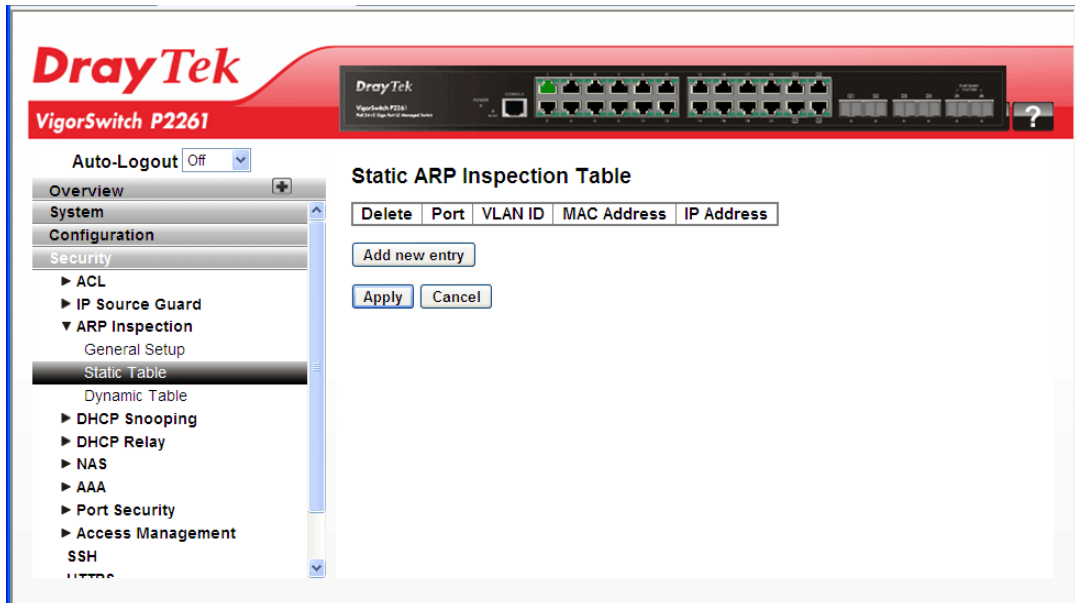

**Parameters description:**

Delete	Check to delete the entry.										
Port	The logical port for the settings.										
VLAN ID	The VLAN ID number for the settings.										
MAC Address	Allowed Source MAC address in ARP request packets.										
IP Address	Allowed Source IP address in ARP request packets.										
Add new entry	Click to add a new entry to the Static ARP Inspection table. Specify the Port, VLAN ID, MAC address, and IP address for the new entry. Click Apply.  <div style="border: 1px solid black; padding: 5px;"> <p><b>Static ARP Inspection Table</b></p> <table border="1" style="width: 100%; border-collapse: collapse;"> <thead> <tr> <th>Delete</th> <th>Port</th> <th>VLAN ID</th> <th>MAC Address</th> <th>IP Address</th> </tr> </thead> <tbody> <tr> <td style="text-align: center;">Delete</td> <td style="text-align: center;">1</td> <td style="text-align: center;">[ ]</td> <td style="text-align: center;">[ ]</td> <td style="text-align: center;">[ ]</td> </tr> </tbody> </table> <p style="text-align: center;">Add new entry</p> <p style="text-align: center;">Apply    Reset</p> </div>	Delete	Port	VLAN ID	MAC Address	IP Address	Delete	1	[ ]	[ ]	[ ]
Delete	Port	VLAN ID	MAC Address	IP Address							
Delete	1	[ ]	[ ]	[ ]							

After finished the above settings, click **Apply** to save the configuration. The settings will take effect.



## 2.4.10 ARP Inspection – Dynamic Table

### Function name:

ARP Inspection – Dynamic Table

### Function description:

The function is used to configure the Dynamic ARP Inspection Table parameters of the switch. The Dynamic ARP Inspection Table contains up to 1024 entries, and is sorted first by port, then by VLAN ID, then by MAC address, and then by IP address.

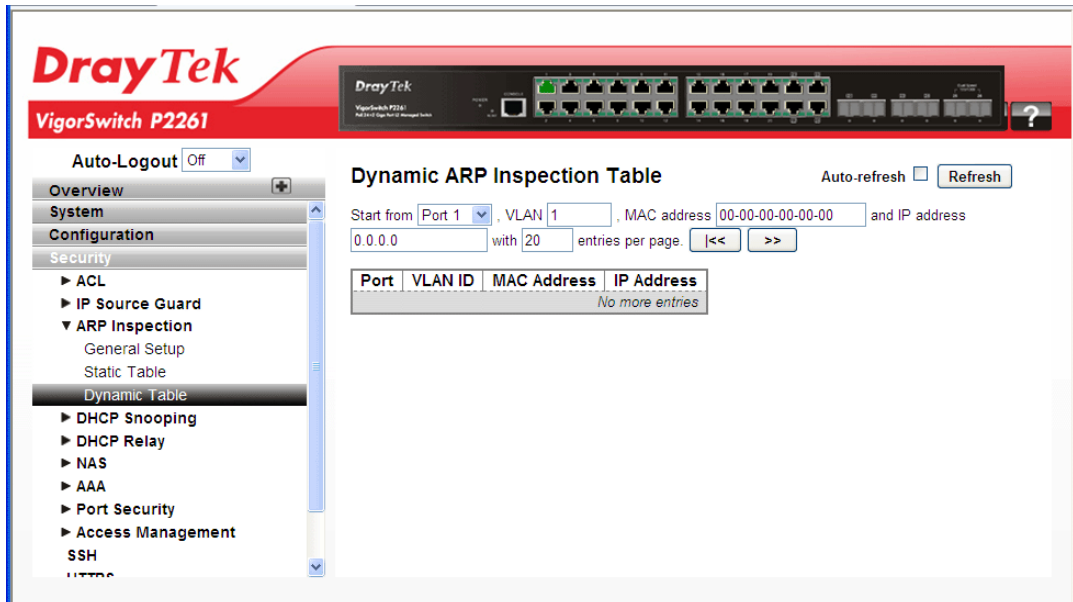

### Parameters description:

Start from Port #	Switch Port Number for which the entries are displayed.
VLAN ID	VLAN-ID in which the ARP traffic is permitted.
MAC Address	User MAC address of the entry.
IP Address	User IP address of the entry.
Auto refresh	The simple counts will be refreshed automatically on the UI screen.
Refresh	The simple counts will be refreshed manually when user use mouse to click on “Refresh” button.

## 2.4.11 DHCP Snooping – General Setup

**Function name:**

DHCP Snooping – General Setup

**Function description:**

The function is used to configure the DHCP Snooping parameters of the switch. The DHCP Snooping can prevent attackers from adding their own DHCP servers to the network.

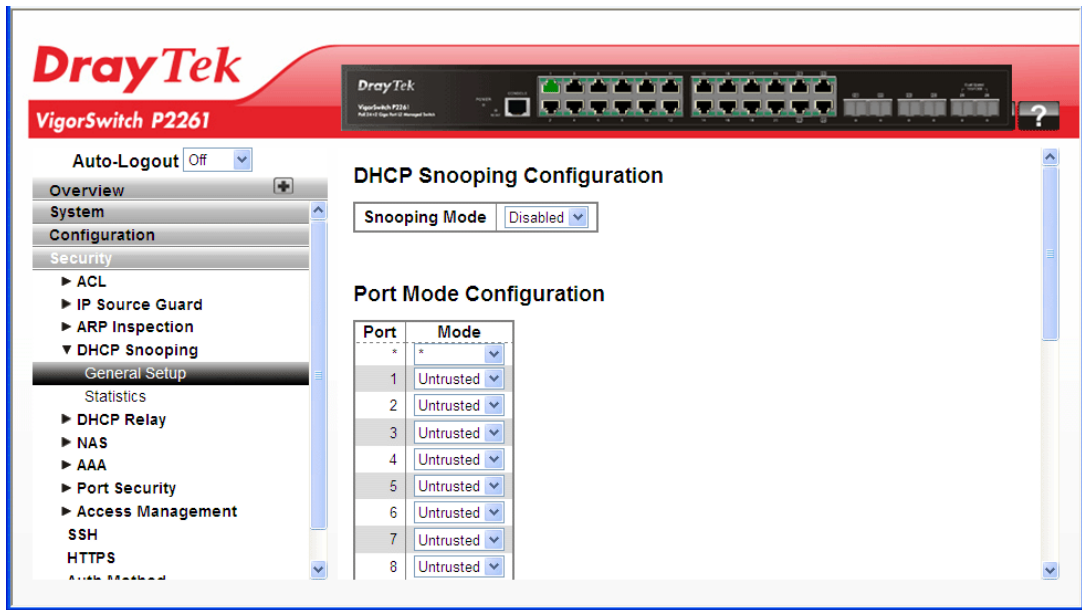

**Parameters description:**

DHCP Snooping Configuration	<p>Snooping Mode - Indicates the DHCP snooping mode operation. Possible modes are:</p> <p>Enabled: Enable DHCP snooping mode operation. When DHCP snooping mode operation is enabled, the DHCP request messages will be forwarded to trusted ports and only allow reply packets from the trusted ports.</p> <p>Disabled: Disable DHCP snooping mode operation.</p>
Port Mode Configuration	<p>Mode - Indicates the DHCP snooping port mode. Possible port modes are:</p> <p>Trusted: Configures the port as trusted source of the DHCP messages.</p> <p>Untrusted: Configures the port as untrusted source of the DHCP messages.</p>

After finished the above settings, click **Apply** to save the configuration. The settings will take effect.

## 2.4.12 DHCP Snooping – Statistics

### Function name:

DHCP Snooping – Statistics

### Function description:

The function is used to show the DHCP Snooping Statistics information of the switch. The statistics show only packet counters when DHCP snooping mode is enabled and relay mode is disabled. And it doesn't count the DHCP packets for DHCP client.

The screenshot shows the DrayTek web management interface for a VigorSwitch P2261. The left sidebar contains a navigation menu with categories like Overview, System, Configuration, Security, and DHCP Snooping. Under DHCP Snooping, the 'Statistics' option is selected. The main panel is titled 'DHCP Snooping Port Statistics' and shows a table with two columns: 'Receive Packets' and 'Transmit Packets'. The table lists various DHCP message types and their corresponding counts, all of which are currently zero.

Receive Packets		Transmit Packets	
Rx Discover	0	Tx Discover	0
Rx Offer	0	Tx Offer	0
Rx Request	0	Tx Request	0
Rx Decline	0	Tx Decline	0
Rx ACK	0	Tx ACK	0
Rx NAK	0	Tx NAK	0
Rx Release	0	Tx Release	0
Rx Inform	0	Tx Inform	0
Rx Lease Query	0	Tx Lease Query	0
Rx Lease Unassigned	0	Tx Lease Unassigned	0
Rx Lease Unknown	0	Tx Lease Unknown	0
Rx Lease Active	0	Tx Lease Active	0

### Parameters description:

Rx and Tx Discover	The number of discover (option 53 with value 1) packets received and transmitted.
Rx and Tx Offer	The number of offer (option 53 with value 2) packets received and transmitted.
Rx and Tx Request	The number of request (option 53 with value 3) packets received and transmitted.
Rx and Tx Decline	The number of decline (option 53 with value 4) packets received and transmitted.
Rx and Tx ACK	The number of ACK (option 53 with value 5) packets received and transmitted.
Rx and Tx NAK	The number of NAK (option 53 with value 6) packets received and transmitted.
Rx and Tx Release	The number of release (option 53 with value 7) packets received and transmitted.
Rx and Tx Inform	The number of inform (option 53 with value 8) packets received and transmitted.
Rx and Tx Lease Query	The number of lease query (option 53 with value 10) packets received and transmitted.
Rx and Tx Lease Unassigned	The number of lease unassigned (option 53 with value 11) packets received and transmitted.

Rx and Tx Lease Unknown	The number of lease unknown (option 53 with value 12) packets received and transmitted.
Rx and Tx Lease Active	The number of lease active (option 53 with value 13) packets received and transmitted.

After finished the above settings, click **Apply** to save the configuration. The settings will take effect.

## 2.4.13 DHCP Relay – General Setup

### Function name:

DHCP Relay – General Setup

### Function description:

The function is used to describe how to forward DHCP requests to another specific DHCP server via DHCP relay. The DHCP servers may be on another network.

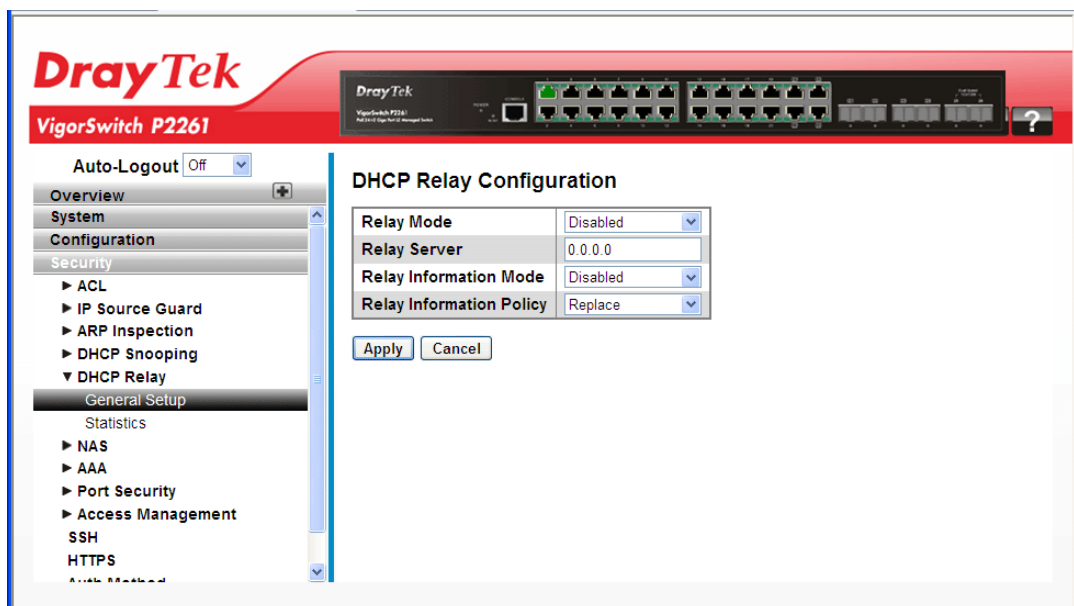

### Parameters description:

Relay Mode	Indicates the DHCP relay mode operation. Possible modes are: Enabled: Enable DHCP relay mode operation. When DHCP relay mode operation is enabled, the agent forwards and transfers DHCP messages between the clients and the server when they are not in the same subnet domain. And the DHCP broadcast message won't be flooded for security considerations. Disabled: Disable DHCP relay mode operation.
Relay Server	Indicates the DHCP relay server IP address. A DHCP relay agent is used to forward and to transfer DHCP messages between the clients and the server when they are not in the same subnet domain.
Relay Information Mode	Indicates the DHCP relay information mode option operation. Possible modes are: Enabled: Enable DHCP relay information mode operation.

	<p>When DHCP relay information mode operation is enabled, the agent inserts specific information (option 82) into a DHCP message when forwarding to DHCP server and removes it from a DHCP message when transferring to DHCP client. It only works when DHCP relay operation mode is enabled.</p> <p>Disabled: Disable DHCP relay information mode operation.</p>
Relay Information Policy	<p>Indicates the DHCP relay information option policy. When DHCP relay information mode operation is enabled, if agent receives a DHCP message that already contains relay agent information it will enforce the policy. And it only works under DHCP if relay information operation mode is enabled. Possible policies are:</p> <p>Replace: Replace the original relay information when a DHCP message that already contains it is received.</p> <p>Keep: Keep the original relay information when a DHCP message that already contains it is received.</p> <p>Drop: Drop the package when a DHCP message that already contains relay information is received.</p>

After finished the above settings, click **Apply** to save the configuration. The settings will take effect.

## 2.4.14 DHCP Relay – Statistics

**Function name:**

DHCP Relay – Statistics

**Function description:**

The function is used to show the DHCP Relay Statistics information of the switch. The statistics show both of Server and Client packet counters when DHCP Relay mode is enabled.

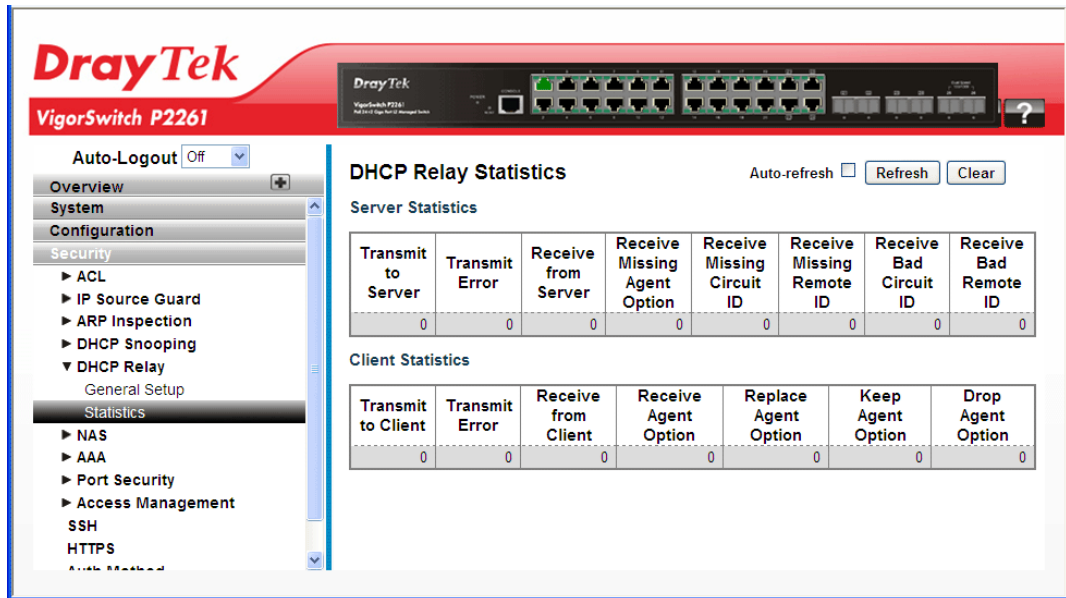

**Parameters description:**

Server Statistics	
Transmit to Server	The number of packets that are relayed from client to server.
Transmit Error	The number of packets that resulted in errors while being sent to clients.
Receive from Server	The number of packets received from server.
Receive Missing Agent Option	The number of packets received without agent information options.
Receive Missing Circuit ID	Receive Missing Circuit ID
Receive Missing Remote ID	The number of packets received with the Remote ID option missing.
Receive Bad Circuit ID	The number of packets whose Circuit ID option did not match known circuit ID.
Receive Bad Remote ID	The number of packets whose Remote ID option did not match known Remote ID.
Client Statistics	
Transmit to Client	The number of relayed packets from server to client.
Transmit Error	The number of packets that resulted in error while being sent to servers.

Receive from Client	The number of received packets from server.
Receive Agent Option	The number of received packets with relay agent information option.
Replace Agent Option	The number of packets which were replaced with relay agent information option.
Keep Agent Option	The number of packets whose relay agent information was retained.
Drop Agent Option	The number of packets that were dropped which were received with relay agent information.

After finished the above settings, click **Apply** to save the configuration. The settings will take effect.

## 2.4.15 NAS – General Setup

### Function name:

NAS – General Setup

### Function description:

The function is used to configure the NAS parameters of the switch. The NAS server can be employed to connect users to a variety of resources including Internet access, conference calls, printing documents on shared printers, or by simply logging on to the Internet.

It can configure NAS setting of IEEE 802.1X, MAC-based authentication system, and port settings. The NAS configuration consists of two sections, a system- and a port-wide.

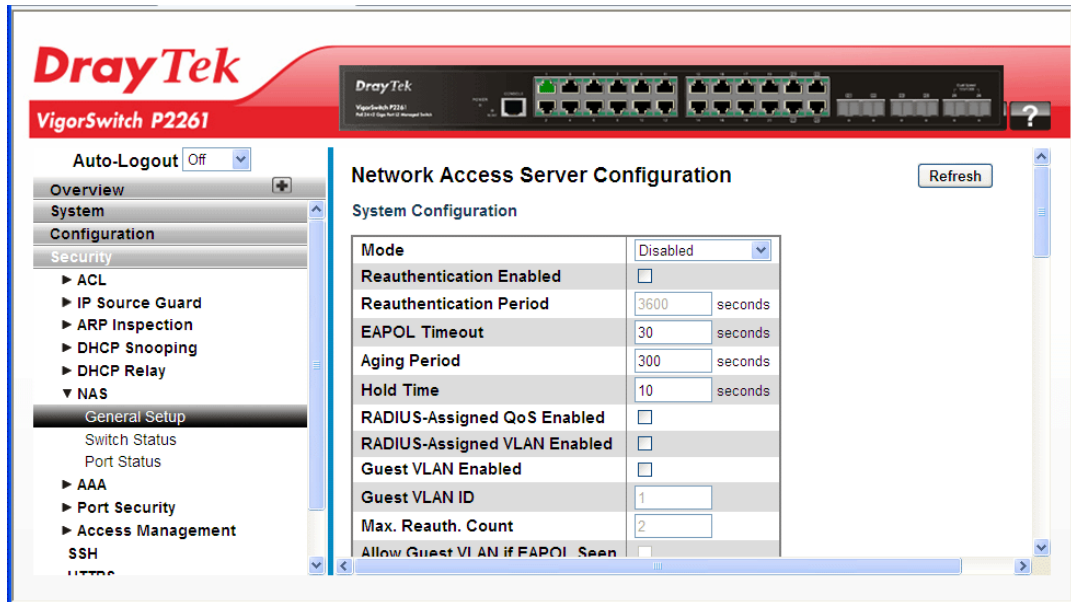

### Parameters description:

System Configuration	
Mode	Indicates if NAS is globally enabled or disabled on the switchstack. If it is disabled, all ports are allowed forwarding of frames.
Reauthentication Enabled	If checked, successfully authenticated supplicants/clients are reauthenticated after the interval specified by the

	<p>Reauthentication Period. Reauthentication for 802.1X-enabled ports can be used to detect if a new device is plugged into a switch port or if a supplicant is no longer attached.</p> <p>For MAC-based ports, reauthentication is only useful if the RADIUS server configuration has changed. It does not involve communication between the switch and the client, and therefore doesn't imply that a client is still present on a port (see Aging Period below).</p>
Reauthentication Period	<p>Determines the period, in seconds, after which a connected client must be reauthenticated. This is only active if the Reauthentication Enabled checkbox is checked. Valid values are in the range 1 to 3600 seconds.</p>
EAPOL Timeout	<p>Determines the time for retransmission of Request Identity EAPOL frames.</p> <p>Valid values are in the range 1 to 255 seconds. This has no effect for MAC-based ports.</p>
Aging Period	<p>This setting applies to the following modes, i.e. modes using the Port Security functionality to secure MAC addresses:</p> <ul style="list-style-type: none"> <li>• Single 802.1X</li> <li>• Multi 802.1X</li> <li>• MAC-Based Auth.</li> </ul> <p>When the NAS module uses the Port Security module to secure MAC addresses, the Port Security module needs to check for activity on the MAC address in question at regular intervals and free resources if no activity is seen within a given period of time. This parameter controls exactly this period and can be set to a number between 10 and 1000000 seconds.</p> <p>If reauthentication is enabled and the port is in an 802.1X-based mode, this is not so critical, since supplicants that are no longer attached to the port will get removed upon the next reauthentication, which will fail. But if reauthentication is not enabled, the only way to free resources is by aging the entries.</p> <p>For ports in MAC-based Auth. mode, reauthentication doesn't cause direct communication between the switch and the client, so this will not detect whether the client is still attached or not, and the only way to free any resources is to age the entry.</p>
Hold Time	<p>This setting applies to the following modes, i.e. modes using the Port Security functionality to secure MAC addresses:</p> <ul style="list-style-type: none"> <li>• Single 802.1X</li> <li>• Multi 802.1X</li> <li>• MAC-Based Auth.</li> </ul> <p>If a client is denied access - either because the RADIUS server denies the client access or because the RADIUS server request times out (according to the timeout specified</p>



	<p>on the "Configuration →Security →AAA" page) - the client is put on hold in the Unauthorized state. The hold timer does not count during an on-going authentication.</p> <p>In MAC-based Auth mode, the switch will ignore new frames coming from the client during the hold time.</p> <p>The Hold Time can be set to a number between 10 and 1000000 seconds.</p>
RADIUS-Assigned QoS Enabled	<p>RADIUS-assigned QoS provides a means to centrally control the traffic class to which traffic coming from a successfully authenticated supplicant is assigned on the switch. The RADIUS server must be configured to transmit special RADIUS attributes to take advantage of this feature (see RADIUS-Assigned QoS Enabled below for a detailed description).</p> <p>The "RADIUS-Assigned QoS Enabled" checkbox provides a quick way to globally enable/disable RADIUS-server assigned QoS Class functionality. When checked, the individual ports' ditto setting determines whether RADIUS-assigned QoS Class is enabled on that port. When unchecked, RADIUS-server assigned QoS Class is disabled on all ports.</p>
RADIUS-Assigned VLAN Enabled	<p>RADIUS-assigned VLAN provides a means to centrally control the VLAN on which a successfully authenticated supplicant is placed on the switch. Incoming traffic will be classified to and switched on the RADIUS-assigned VLAN. The RADIUS server must be configured to transmit special RADIUS attributes to take advantage of this feature (see RADIUS-Assigned VLAN Enabled below for a detailed description).</p> <p>The "RADIUS-Assigned VLAN Enabled" checkbox provides a quick way to globally enable/disable RADIUS-server assigned VLAN functionality. When checked, the individual ports' ditto setting determines whether RADIUS-assigned VLAN is enabled on that port. When unchecked, RADIUS-server assigned VLAN is disabled on all ports.</p>
Guest VLAN Enabled	<p>A Guest VLAN is a special VLAN - typically with limited network access - on which 802.1X-unaware clients are placed after a network administrator-defined timeout. The switch follows a set of rules for entering and leaving the Guest VLAN as listed below.</p> <p>The "Guest VLAN Enabled" checkbox provides a quick way to globally enable/disable Guest VLAN functionality. When checked, the individual ports' ditto setting determines whether the port can be moved into Guest VLAN. When unchecked, the ability to move to the Guest VLAN is disabled on all ports.</p>
Guest VLAN ID	<p>This is the value that a port's Port VLAN ID is set to if a port is moved into the Guest VLAN. It is only changeable if the Guest VLAN option is globally enabled.</p> <p>Valid values are in the range [1; 4095].</p>

Max. Reauth. Count	<p>The number of times the switch transmits an EAPOL Request Identity frame without response before considering entering the Guest VLAN is adjusted with this setting. The value can only be changed if the Guest VLAN option is globally enabled.</p> <p>Valid values are in the range [1; 255].</p>
Allow Guest VLAN if EAPOL Seen	<p>The switch remembers if an EAPOL frame has been received on the port for the life-time of the port. Once the switch considers whether to enter the Guest VLAN, it will first check if this option is enabled or disabled. If disabled (unchecked; default), the switch will only enter the Guest VLAN if an EAPOL frame has not been received on the port for the life-time of the port. If enabled (checked), the switch will consider entering the Guest VLAN even if an EAPOL frame has been received on the port for the life-time of the port.</p> <p>The value can only be changed if the Guest VLAN option is globally enabled.</p>
<b>Port Configuration</b>	
Port	The port number for which the configuration below applies.
Admin State	<p>If NAS is globally enabled, this selection controls the port's authentication mode. The following modes are available:</p> <p><i>Force Authorized</i> - In this mode, the switch will send one EAPOL Success frame when the port link comes up, and any client on the port will be allowed network access without authentication.</p> <p><i>Force Unauthorized</i> - In this mode, the switch will send one EAPOL Failure frame when the port link comes up, and any client on the port will be disallowed network access.</p> <p><i>Port-based 802.1X</i> - In the 802.1X-world, the user is called the supplicant, the switch is the authenticator, and the RADIUS server is the authentication server. The authenticator acts as the man-in-the-middle, forwarding requests and responses between the supplicant and the authentication server. Frames sent between the supplicant and the switch are special 802.1X frames, known as EAPOL (EAP Over LANs) frames. EAPOL frames encapsulate EAP PDUs (RFC3748). Frames sent between the switch and the RADIUS server are RADIUS packets. RADIUS packets also encapsulate EAP PDUs together with other attributes like the switch's IP address, name, and the supplicant's port number on the switch. EAP is very flexible, in that it allows for different authentication methods, like MD5-Challenge, PEAP, and TLS. The important thing is that the authenticator (the switch) doesn't need to know which authentication method the supplicant and the authentication server are using, or how many information exchange frames are needed for a particular method. The switch simply encapsulates the EAP part of the frame into the relevant type (EAPOL or RADIUS) and forwards it.</p> <p>When authentication is complete, the RADIUS server sends</p>

---

a special packet containing a success or failure indication. Besides forwarding this decision to the supplicant, the switch uses it to open up or block traffic on the switch port connected to the supplicant.

**Note:** Suppose two backend servers are enabled and that the server timeout is configured to X seconds (using the AAA configuration page), and suppose that the first server in the list is currently down (but not considered dead). Now, if the supplicant retransmits EAPOL Start frames at a rate faster than X seconds, then it will never get authenticated, because the switch will cancel on-going backend authentication server requests whenever it receives a new EAPOL Start frame from the supplicant. And since the server hasn't yet failed (because the X seconds haven't expired), the same server will be contacted upon the next backend authentication server request from the switch. This scenario will loop forever. Therefore, the server timeout should be smaller than the supplicant's EAPOL Start frame retransmission rate.

*Single 802.1X* - In port-based 802.1X authentication, once a supplicant is successfully authenticated on a port, the whole port is opened for network traffic. This allows other clients connected to the port (for instance through a hub) to piggy-back on the successfully authenticated client and get network access even though they really aren't authenticated. To overcome this security breach, use the Single 802.1X variant. Single 802.1X is really not an IEEE standard, but features many of the same characteristics as does port-based 802.1X. In Single 802.1X, at most one supplicant can get authenticated on the port at a time. Normal EAPOL frames are used in the communication between the supplicant and the switch. If more than one supplicant is connected to a port, the one that comes first when the port's link comes up will be the first one considered. If that supplicant doesn't provide valid credentials within a certain amount of time, another supplicant will get a chance. Once a supplicant is successfully authenticated, only that supplicant will be allowed access. This is the most secure of all the supported modes. In this mode, the Port Security module is used to secure a supplicant's MAC address once successfully authenticated.

*Multi 802.1X* - In port-based 802.1X authentication, once a supplicant is successfully authenticated on a port, the whole port is opened for network traffic. This allows other clients connected to the port (for instance through a hub) to piggy-back on the successfully authenticated client and get network access even though they really aren't authenticated. To overcome this security breach, use the Multi 802.1X variant.

Multi 802.1X is really not an IEEE standard, but features many of the same characteristics as does port-based 802.1X. Multi 802.1X is - like Single 802.1X - not an IEEE standard, but a variant that features many of the same

---

---

characteristics. In Multi 802.1X, one or more supplicants can get authenticated on the same port at the same time. Each supplicant is authenticated individually and secured in the MAC table using the Port Security module.

In Multi 802.1X it is not possible to use the multicast BPDU MAC address as destination MAC address for EAPOL frames sent from the switch towards the supplicant, since that would cause all supplicants attached to the port to reply to requests sent from the switch. Instead, the switch uses the supplicant's MAC address, which is obtained from the first EAPOL Start or EAPOL Response Identity frame sent by the supplicant. An exception to this is when no supplicants are attached. In this case, the switch sends EAPOL Request Identity frames using the BPDU multicast MAC address as destination - to wake up any supplicants that might be on the port.

The maximum number of supplicants that can be attached to a port can be limited using the Port Security Limit Control functionality.

*MAC-based Auth.* - Unlike port-based 802.1X, MAC-based authentication is not a standard, but merely a best-practices method adopted by the industry. In MAC-based authentication, users are called clients, and the switch acts as the supplicant on behalf of clients. The initial frame (any kind of frame) sent by a client is snooped by the switch, which in turn uses the client's MAC address as both username and password in the subsequent EAP exchange with the RADIUS server. The 6-byte MAC address is converted to a string on the following form "xx-xx-xx-xx-xx-xx", that is, a dash (-) is used as separator between the lower-cased hexadecimal digits. The switch only supports the MD5-Challenge authentication method, so the RADIUS server must be configured accordingly. When authentication is complete, the RADIUS server sends a success or failure indication, which in turn causes the switch to open up or block traffic for that particular client, using the Port Security module. Only then will frames from the client be forwarded on the switch. There are no EAPOL frames involved in this authentication, and therefore, MAC-based Authentication has nothing to do with the 802.1X standard.

The advantage of MAC-based authentication over port-based 802.1X is that several clients can be connected to the same port (e.g. through a 3rd party switch or a hub) and still require individual authentication, and that the clients don't need special supplicant software to authenticate. The advantage of MAC-based authentication over 802.1X-based authentication is that the clients don't need special supplicant software to authenticate. The disadvantage is that MAC addresses can be spoofed by malicious users - equipment whose MAC address is a valid RADIUS user can be used by anyone. Also, only the MD5-Challenge method is supported. The maximum number of clients that can be

---

	<p>attached to a port can be limited using the Port Security Limit Control functionality.</p>
<p>RADIUS-Assigned QoS Enabled</p>	<p>When RADIUS-Assigned QoS is both globally enabled and enabled (checked) on a given port, the switch reacts to QoS Class information carried in the RADIUS Access-Accept packet transmitted by the RADIUS server when a supplicant is successfully authenticated. If present and valid, traffic received on the supplicant's port will be classified to the given QoS Class. If (re-)authentication fails or the RADIUS Access-Accept packet no longer carries a QoS Class or it's invalid, or the supplicant is otherwise no longer present on the port, the port's QoS Class is immediately reverted to the original QoS Class (which may be changed by the administrator in the meanwhile without affecting the RADIUS-assigned).</p> <p>This option is only available for single-client modes, i.e.</p> <ul style="list-style-type: none"> <li>• Port-based 802.1X</li> <li>• Single 802.1X</li> </ul> <p>RADIUS attributes used in identifying a QoS Class: Refer to the written documentation for a description of the RADIUS attributes needed in order to successfully identify a QoS Class. The User-Priority-Table attribute defined in RFC4675 forms the basis for identifying the QoS Class in an Access-Accept packet.</p> <p>Only the first occurrence of the attribute in the packet will be considered, and to be valid, it must follow this rule:</p> <ul style="list-style-type: none"> <li>• All 8 octets in the attribute's value must be identical and consist of ASCII characters in the range '0' - '3', which translates into the desired QoS Class in the range [0; 3].</li> </ul>
<p>RADIUS-Assigned VLAN Enabled</p>	<p>When RADIUS-Assigned VLAN is both globally enabled and enabled (checked) for a given port, the switch reacts to VLAN ID information carried in the RADIUS Access-Accept packet transmitted by the RADIUS server when a supplicant is successfully authenticated. If present and valid, the port's Port VLAN ID will be changed to this VLAN ID, the port will be set to be a member of that VLAN ID, and the port will be forced into VLAN unaware mode. Once assigned, all traffic arriving on the port will be classified and switched on the RADIUS-assigned VLAN ID.</p> <p>If (re-)authentication fails or the RADIUS Access-Accept packet no longer carries a VLAN ID or it's invalid, or the supplicant is otherwise no longer present on the port, the port's VLAN ID is immediately reverted to the original VLAN ID (which may be changed by the administrator in the meanwhile without affecting the RADIUS-assigned).</p> <p>This option is only available for single-client modes, i.e.</p> <ul style="list-style-type: none"> <li>• Port-based 802.1X</li> <li>• Single 802.1X</li> </ul> <p>For trouble-shooting VLAN assignments, use the "Monitor → VLANs → VLAN Membership and VLAN Port" pages.</p>

	<p>These pages show which modules have (temporarily) overridden the current Port VLAN configuration.</p> <p>RADIUS attributes used in identifying a VLAN ID: RFC2868 and RFC3580 form the basis for the attributes used in identifying a VLAN ID in an Access-Accept packet. The following criteria are used:</p> <ul style="list-style-type: none"> <li>• The Tunnel-Medium-Type, Tunnel-Type, and Tunnel-Private-Group-ID attributes must all be present at least once in the Access-Accept packet.</li> <li>• The switch looks for the first set of these attributes that have the same Tag value and fulfill the following requirements (if Tag == 0 is used, the Tunnel-Private-Group-ID does not need to include a Tag): <ul style="list-style-type: none"> <li>- Value of Tunnel-Medium-Type must be set to "IEEE-802" (ordinal 6).</li> <li>- Value of Tunnel-Type must be set to "VLAN" (ordinal 13).</li> <li>- Value of Tunnel-Private-Group-ID must be a string of ASCII chars in the range '0' - '9', which is interpreted as a decimal string representing the VLAN ID. Leading '0's are discarded. The final value must be in the range [1; 4095].</li> </ul> </li> </ul>
Guest VLAN Enabled	<p>When Guest VLAN is both globally enabled and enabled (checked) for a given port, the switch considers moving the port into the Guest VLAN according to the rules outlined below.</p> <p>This option is only available for EAPOL-based modes, i.e.:</p> <ul style="list-style-type: none"> <li>• Port-based 802.1X</li> <li>• Single 802.1X</li> <li>• Multi 802.1X</li> </ul> <p>For trouble-shooting VLAN assignments, use the "Monitor → VLANs → VLAN Membership and VLAN Port" pages. These pages show which modules have (temporarily) overridden the current Port VLAN configuration.</p> <p>Guest VLAN Operation:</p> <p>When a Guest VLAN enabled port's link comes up, the switch starts transmitting EAPOL Request Identity frames. If the number of transmissions of such frames exceeds Max. Reauth. Count and no EAPOL frames have been received. In the meanwhile, the switch considers entering the Guest VLAN. The interval between the transmission of EAPOL Request Identity frames is configured with EAPOL Timeout. If Allow Guest VLAN if EAPOL Seen is enabled, the port will now be placed in the Guest VLAN. If disabled, the switch will first check its history to see if an EAPOL frame has previously been received on the port (this history is cleared if the port link goes down or the port's Admin State is changed), and if not, the port will be placed in the Guest VLAN. Otherwise it will not move to the Guest VLAN, but continue transmitting EAPOL Request Identity frames at the rate given by EAPOL Timeout.</p> <p>Once in the Guest VLAN, the port is considered</p>

	<p>authenticated, and all attached clients on the port are allowed access on this VLAN. The switch will not transmit an EAPOL Success frame when entering the Guest VLAN. While in the Guest VLAN, the switch monitors the link for EAPOL frames, and if one such frame is received, the switch immediately takes the port out of the Guest VLAN and starts authenticating the supplicant according to the port mode. If an EAPOL frame is received, the port will never be able to go back into the Guest VLAN if the "Allow Guest VLAN if EAPOL Seen" is disabled.</p>
Port State	<p>The current state of the port. It can undertake one of the following values:</p> <p><i>Globally Disabled:</i> NAS is globally disabled.</p> <p><i>Link Down:</i> NAS is globally enabled, but there is no link on the port.</p> <p><i>Authorized:</i> The port is in Force Authorized or a single-supplicant mode and the supplicant is authorized.</p> <p><i>Unauthorized:</i> The port is in Force Unauthorized or a single-supplicant mode and the supplicant is not successfully authorized by the RADIUS server.</p> <p><i>X Auth/Y Unauth:</i> The port is in a multi-supplicant mode. Currently X clients are authorized and Y are unauthorized.</p>
Restart	<p>Two buttons are available for each row. The buttons are only enabled when authentication is globally enabled and the port's Admin State is in an EAPOL-based or MAC-based mode.</p> <p>Clicking these buttons will not cause settings changed on the page to take effect.</p> <p><i>Reauthenticate:</i> Schedules a reauthentication whenever the quiet-period of the port runs out (EAPOL-based authentication). For MAC-based authentication, reauthentication will be attempted immediately.</p> <p>The button only has effect for successfully authenticated clients on the port and will not cause the clients to get temporarily unauthorized.</p> <p><i>Reinitialize:</i> Forces a reinitialization of the clients on the port and thereby a reauthentication immediately. The clients will transfer to the unauthorized state while the reauthentication is in progress.</p>

After finished the above settings, click **Apply** to save the configuration. The settings will take effect.

## 2.4.16 NAS – Switch Status

### Function name:

NAS – Switch Status

### Function description:

The function is used to show the each port NAS status information of the switch. The status includes Admin State Port State, Last Source, Last ID, QoS Class, and Port VLAN ID.

The screenshot shows the DrayTek VigorSwitch P2261 web interface. The main content area is titled "Network Access Server Switch Status" and contains a table with the following data:

Port	Admin State	Port State	Last Source	Last ID	QoS Class	Port VLAN ID
1	Force Authorized	Globally Disabled				
2	Force Authorized	Globally Disabled				
3	Force Authorized	Globally Disabled				
4	Force Authorized	Globally Disabled				
5	Force Authorized	Globally Disabled				
6	Force Authorized	Globally Disabled				
7	Force Authorized	Globally Disabled				
8	Force Authorized	Globally Disabled				

### Parameters description:

Port	The switch port number. Click to navigate to detailed NAS statistics for this port.
Admin State	The port's current administrative state. Refer to NAS Admin State for a description of possible values.
Port State	The current state of the port. Refer to NAS Port State for a description of the individual states.
Last Source	The source MAC address carried in the most recently received EAPOL frame for EAPOL-based authentication, and the most recently received frame from a new client for MAC-based authentication.
Last ID	The user name (supplicant identity) carried in the most recently received Response Identity EAPOL frame for EAPOL-based authentication, and the source MAC address from the most recently received frame from a new client for MAC-based authentication.
QoS Class	QoS Class assigned to the port by the RADIUS server if enabled.
Port VLAN ID	The VLAN ID that NAS has put the port in. The field is blank, if the Port VLAN ID is not overridden by NAS. If the VLAN ID is assigned by the RADIUS server, "(RADIUS-assigned)" is appended to the VLAN ID. Read more about RADIUS-assigned VLANs here. If the port is moved to the Guest VLAN, "(Guest)" is



	appended to the VLAN ID. Read more about Guest VLANs here.
Auto refresh	The simple counts will be refreshed automatically on the UI screen.
Refresh	The simple counts will be refreshed manually when user use mouse to click on “Refresh” button.

After finished the above settings, click **Apply** to save the configuration. The settings will take effect.

## 2.4.17 NAS – Port Status

**Function name:**

NAS – Port Status

**Function description:**

The function is used to provide detailed NAS statistics for a specific switch port running EAPOL-based IEEE 802.1X authentication.

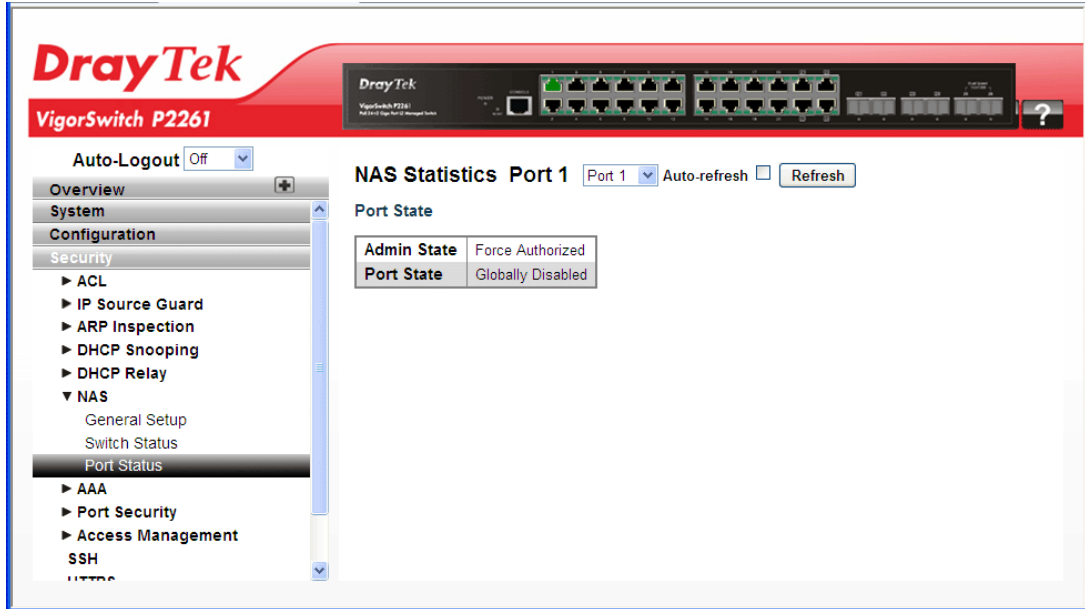

**Parameters description:**

Port State	
Admin State	The port's current administrative state. Refer to NAS Admin State for a description of possible values.
Port State	The current state of the port. Refer to NAS Port State for a description of the individual states.
Auto refresh	The simple counts will be refreshed automatically on the UI screen.
Refresh	The simple counts will be refreshed manually when user use mouse to click on “Refresh” button.

## 2.4.18 AAA – General Setup

### Function name:

AAA – General Setup

### Function description:

The function uses an AAA (Authentication, Authorization, Accounting) server to provide access control to your network. The AAA server can be a TACACS+ or RADIUS server to create and manage objects that contain settings for using AAA servers.

The function describes how to configure AAA setting of TACACS+ or RADIUS server.

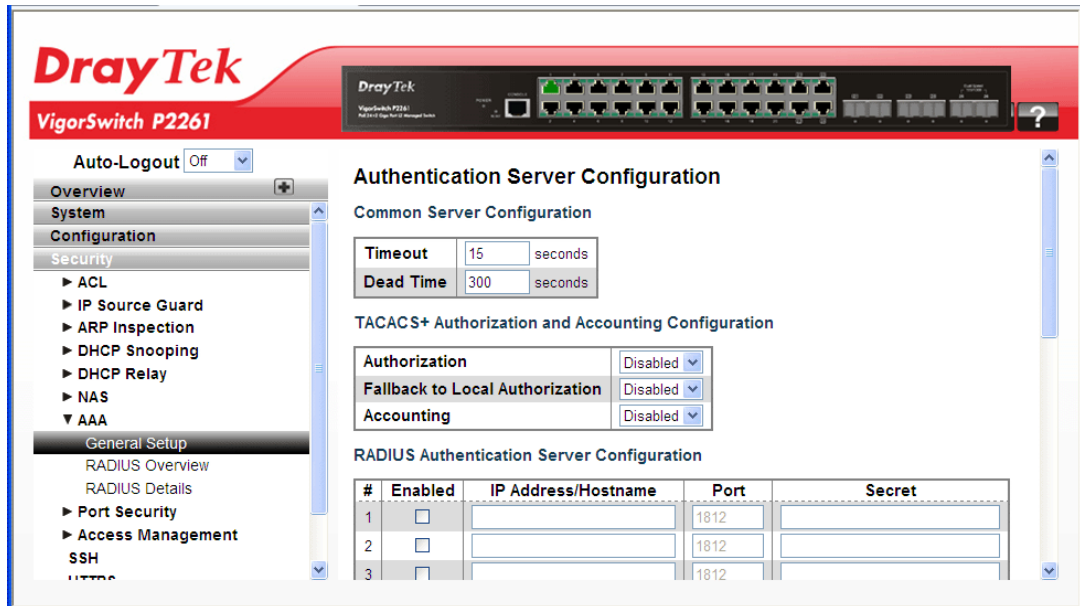

### Parameters description:

Common Server Configuration	
Timeout	<p>The Timeout, which can be set to a number between 3 and 3600 seconds, is the maximum time to wait for a reply from a server.</p> <p>If the server does not reply within this timeframe, we will consider it to be dead and continue with the next enabled server (if any).</p> <p>RADIUS servers are using the UDP protocol, which is unreliable by design. In order to cope with lost frames, the timeout interval is divided into 3 subintervals of equal length. If a reply is not received within the subinterval, the request is transmitted again. This algorithm causes the RADIUS server to be queried up to 3 times before it is considered to be dead.</p>
Dead Time	<p>The Dead Time, which can be set to a number between 0 and 3600 seconds, is the period during which the switch will not send new requests to a server that has failed to respond to a previous request. This will stop the switch from continually trying to contact a server that it has already determined as dead.</p> <p>Setting the Dead Time to a value greater than 0 (zero) will</p>

	enable this feature, but only if more than one server has been configured.
--	--

#### TACACS + Authorization and Accounting Configuration

<b>Authorization</b>	Every CLI commands will be authorized by TACACS+ server when enable. The authorization table on the TACACS+ server is able to configure which CLI command can pass successfully. For example, TACACS+ server is set to accept STP command but deny VLAN command. The server will block the command related to STP which entered by user, but it can allow VLAN command to configure successfully when user enter VLAN command.
<b>Fallback to Local Authorization</b>	Enable to allow the user who typed wrong account or password to login successfully when the user account is on the local authorization list of the local switch. For example, when user entered the wrong account or password, TACACS+ server will refer to the account information on the local end of switch. If the account is recorded on the local switch, the user will be authorized to login with the privilege level set on the local switch.
<b>Accounting</b>	Enable to record all the command users entered. All the log data will be recorded on the server when enable. For instance, login time, log out time, IGMP setting, VLAN setting, etc.

#### RADIUS Authentication Server Configuration

Enabled	Enable the RADIUS Authentication Server by checking this box.
IP Address/Hostname	The IP address or hostname of the RADIUS Authentication Server. IP address is expressed in dotted decimal notation.
Port	The UDP port to use on the RADIUS Authentication Server. If the port is set to 0 (zero), the default port (1812) is used on the RADIUS Authentication Server.
Secret	The secret - up to 29 characters long - shared between the RADIUS Authentication Server and the switch stack.

#### RADIUS Accounting Server Configuration

Enabled	Enable the RADIUS Accounting Server by checking this box.
IP Address/Hostname	The IP address or hostname of the RADIUS Accounting Server. IP address is expressed in dotted decimal notation.
Port	The UDP port to use on the RADIUS Accounting Server. If the port is set to 0 (zero), the default port (1813) is used on the RADIUS Accounting Server.
Secret	The secret - up to 29 characters long - shared between the RADIUS Accounting Server and the switch stack.

---

### TACACS+ Authentication Server Configuration

---

Enabled	Enable the TACACS+ Authentication Server by checking this box.
IP Address/Hostname	The IP address or hostname of the TACACS+ Authentication Server. IP address is expressed in dotted decimal notation.
Port	The TCP port to use on the TACACS+ Authentication Server. If the port is set to 0 (zero), the default port (49) is used on the TACACS+ Authentication Server.
Secret	The secret - up to 29 characters long - shared between the TACACS+ Authentication Server and the switch stack.

---

After finished the above settings, click **Apply** to save the configuration. The settings will take effect.

## 2.4.19 AAA – RADIUS Overview

### Function name:

AAA – RADIUS Overview

### Function description:

The function shows you an overview of the RADIUS Authentication and Accounting server status to ensure the function is workable.

The screenshot shows the DrayTek VigorSwitch P2261 web interface. The main content area is titled 'RADIUS Authentication Server Status Overview' and 'RADIUS Accounting Server Status Overview'. Both sections contain a table with columns for '#', 'IP Address', and 'Status'. All entries in both tables are currently 'Disabled'.

#	IP Address	Status
1	0.0.0.1812	Disabled
2	0.0.0.1812	Disabled
3	0.0.0.1812	Disabled
4	0.0.0.1812	Disabled
5	0.0.0.1812	Disabled

#	IP Address	Status
1	0.0.0.1813	Disabled
2	0.0.0.1813	Disabled
3	0.0.0.1813	Disabled
4	0.0.0.1813	Disabled
5	0.0.0.1813	Disabled

### Parameters description:

IP Address	The IP address and UDP port number (in <IP Address>:<UDP Port> notation) of this server.
Status	<p>The current state of the server. This field takes one of the following values:</p> <p><i>Disabled:</i> The server is disabled.</p> <p><i>Not Ready:</i> The server is enabled, but IP communication is not yet up and running.</p> <p><i>Ready:</i> The server is enabled, IP communication is up and running, and the RADIUS module is ready to accept access/accounting attempts.</p> <p><i>Dead (X seconds left):</i> Access/accounting attempts were made to this server, but it did not reply within the configured timeout. The server has temporarily been disabled, but will get re-enabled when the dead-time expires. The number of seconds left before this occurs is displayed in parentheses. This state is only reachable when more than one server is enabled.</p>
Auto refresh	The simple counts will be refreshed automatically on the UI screen.
Refresh	The simple counts will be refreshed manually when user use mouse to click on “Refresh” button.

## 2.4.20 AAA – RADIUS Details

### Function name:

AAA – RADIUS Details

### Function description:

The function shows you a detailed statistics of the RADIUS Authentication and Accounting servers. The statistics map closely to those specified in RFC4668 - RADIUS Authentication Client MIB.

There are seven counters for receive packets and four counters for transmit packets.

The screenshot shows the DrayTek VigorSwitch P2261 web interface. The left sidebar contains a navigation menu with categories like Overview, System, Configuration, and Security. The main content area is titled 'RADIUS Authentication Status' for 'Server #1'. It features a table with two columns: 'Receive Packets' and 'Transmit Packets'. The 'Receive Packets' column includes counters for Access Accepts, Access Rejects, Access Challenges, Malformed Access Responses, Bad Authenticators, Unknown Types, and Packets Dropped. The 'Transmit Packets' column includes counters for Access Requests, Access Retransmissions, Pending Requests, and Timeouts. Below the table is an 'Other Info' section with fields for IP Address (0.0.0.0:1812), State (Disabled), and Round-Trip Time (0 ms). There are also buttons for 'Auto-refresh', 'Refresh', and 'Clear'.

### Parameters description:

<b>RADIUS Authentication Statistics</b>	Use the server selection box to switch between the backend servers to show details for.
<b>Access Accepts</b>	The number of RADIUS Access-Accept packets (valid or invalid) received from the server.
<b>Access Rejects</b>	The number of RADIUS Access-Reject packets (valid or invalid) received from the server.
<b>Access Challenges</b>	The number of RADIUS Access-Challenge packets (valid or invalid) received from the server.
<b>Malformed Access Responses</b>	The number of malformed RADIUS Access-Response packets received from the server. Malformed packets include packets with an invalid length. Bad authenticators or Message Authenticator attributes or unknown types are not included as malformed access responses.
<b>Bad Authenticators</b>	The number of RADIUS Access-Response packets containing invalid authenticators or Message Authenticator attributes received from the server.
<b>Unknown Types</b>	The number of RADIUS packets that were received

	with unknown types from the server on the authentication port and dropped.
<b>Packets Dropped</b>	The number of RADIUS packets that were received from the server on the authentication port and dropped for some other reason.
<b>Access Requests</b>	The number of RADIUS Access-Request packets sent to the server. This does not include retransmissions.
<b>Access Retransmissions</b>	The number of RADIUS Access-Request packets retransmitted to the RADIUS authentication server.
<b>Pending Requests</b>	The number of RADIUS Access-Request packets destined for the server that have not yet timed out or received a response. This variable is incremented when an Access-Request is sent and decremented due to receipt of an Access-Accept, Access-Reject, Access-Challenge, timeout, or retransmission.
<b>Timeouts</b>	The number of authentication timeouts to the server. After a timeout, the client may retry to the same server, send to a different server, or give up. A retry to the same server is counted as a retransmit as well as a timeout. A send to a different server is counted as a Request as well as a timeout.
<b>IP Address</b>	IP address and UDP port for the authentication server in question.
<b>State</b>	Shows the state of the server. It takes one of the following values: Disabled: The selected server is disabled. Not Ready: The server is enabled, but IP communication is not yet up and running. Ready: The server is enabled, IP communication is up and running, and the RADIUS module is ready to accept access attempts. Dead (X seconds left): Access attempts were made to this server, but it did not reply within the configured timeout. The server has temporarily been disabled, but will get re-enabled when the dead-time expires. The number of seconds left before this occurs is displayed in parentheses. This state is only reachable when more than one server is enabled.
<b>Round-Trip Time</b>	The time interval (measured in milliseconds) between the most recent Access-Reply/Access-Challenge and the Access-Request that matched it from the RADIUS authentication server. The granularity of this measurement is 100 ms. A value of 0 ms indicates that there hasn't been round-trip communication with the server yet.



Auto refresh	The simple counts will be refreshed automatically on the UI screen.
Refresh	The simple counts will be refreshed manually when user use mouse to click on “Refresh” button.

## 2.4.21 Port Security – Limit Control

### Function name:

Port Security – Limit Control

### Function description:

The function shows you how to configure the Port Security settings of the Switch. You can use the Port Security feature to restrict input to an interface by limiting and identifying MAC addresses.

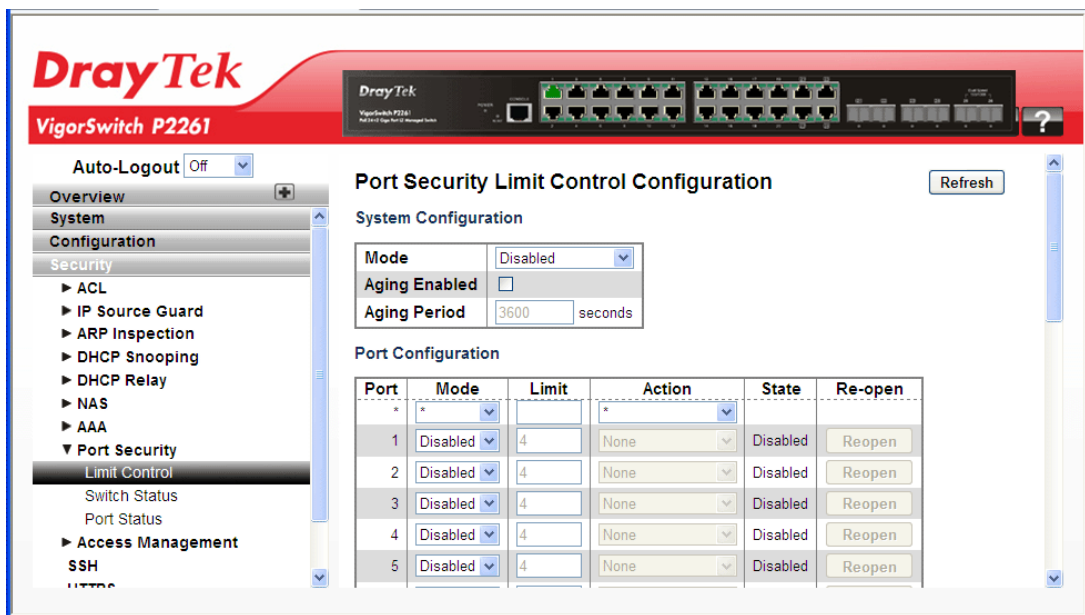

### Parameters description:

System Configuration	
Mode	Indicates if Limit Control is globally enabled or disabled on the switchstack. If globally disabled, other modules may still use the underlying functionality, but limit checks and corresponding actions are disabled.
Aging Enabled	If checked, secured MAC addresses are subject to aging as discussed under Aging Period.
Aging Period	If Aging Enabled is checked, then the aging period is controlled with this input. If other modules are using the underlying port security for securing MAC addresses, they may have other requirements to the aging period. The underlying port security will use the shorter requested aging period of all modules that use the functionality. The Aging Period can be set to a number between 10 and 10,000,000 seconds.  To understand why aging may be desired, consider the following scenario: Suppose an end-host is connected to a

	<p>3rd party switch or hub, which in turn is connected to a port on this switch on which Limit Control is enabled. The end-host will be allowed to forward if the limit is not exceeded.</p> <p>Now suppose that the end-host logs off or powers down. If it wasn't for aging, the end-host would still take up resources on this switch and will be allowed to forward. To overcome this situation, enable aging. With aging enabled, a timer is started once the end-host gets secured. When the timer expires, the switch starts looking for frames from the end-host, and if such frames are not seen within the next Aging Period, the end-host is assumed to be disconnected, and the corresponding resources are freed on the switch.</p>
<b>Port Configuration</b>	
Port	The port number to which the configuration below applies.
Mode	Controls whether Limit Control is enabled on this port. Both this and the Global Mode must be set to Enabled for Limit Control to be in effect. Notice that other modules may still use the underlying port security features without enabling Limit Control on a given port.
Limit	<p>The maximum number of MAC addresses that can be secured on this port. This number cannot exceed 1024. If the limit is exceeded, the corresponding action is taken.</p> <p>The stackswitch is "born" with a total number of MAC addresses from which all ports draw whenever a new MAC address is seen on a Port Security-enabled port. Since all ports draw from the same pool, it may happen that a configured maximum cannot be granted, if the remaining ports have already used all available MAC addresses.</p>
Action	<p>If Limit is reached, the switch can take one of the following actions:</p> <p>None: Do not allow more than Limit MAC addresses on the port, but take no further action.</p> <p>Trap: If Limit + 1 MAC addresses are seen on the port, send an SNMP trap. If Aging is disabled, only one SNMP trap will be sent, but with Aging enabled, new SNMP traps will be sent every time the limit gets exceeded.</p> <p>Shutdown: If Limit + 1 MAC addresses is seen on the port, shut down the port. This implies that all secured MAC addresses will be removed from the port, and no new address will be learned. Even if the link is physically disconnected and reconnected on the port (by disconnecting the cable), the port will remain shut down. There are three ways to re-open the port:</p> <ol style="list-style-type: none"> <li>1) Boot the stack or elect a new master the switch,</li> <li>2) Disable and re-enable Limit Control on the port or the stackswitch,</li> <li>3) Click the Reopen button.</li> </ol> <p>Trap &amp; Shutdown: If Limit + 1 MAC addresses is seen on the port, both the "Trap" and the "Shutdown" actions</p>

	described above will be taken.
State	<p>This column shows the current state of the port as seen from the Limit Control's point of view. The state takes one of four values:</p> <p><i>Disabled:</i> Limit Control is either globally disabled or disabled on the port.</p> <p><i>Ready:</i> The limit is not yet reached. This can be shown for all actions.</p> <p><i>Limit Reached:</i> Indicates that the limit is reached on this port. This state can only be shown if Action is set to None or Trap.</p> <p><i>Shutdown:</i> Indicates that the port is shut down by the Limit Control module. This state can only be shown if Action is set to Shutdown or Trap &amp; Shutdown.</p>
Re-open Button	<p>If a port is shutdown by this module, you may reopen it by clicking this button, which will only be enabled if this is the case. For other methods, refer to Shutdown in the Action section.</p> <p>Note that clicking the reopen button causes the page to be refreshed, so non-committed changes will be lost.</p>
Refresh	The simple counts will be refreshed manually when user use mouse to click on "Refresh" button.

After finished the above settings, click **Apply** to save the configuration. The settings will take effect.

## 2.4.22 Port Security – Switch Status

### Function name:

Port Security – Switch Status

### Function description:

This function shows the Port Security status. Port Security is a module with no direct configuration. Configuration comes indirectly from other modules - the user modules. When a user module has enabled port security on a port, the port is set-up for software-based learning. In this mode, frames from unknown MAC addresses are passed on to the port security module, which in turn asks all user modules whether to allow this new MAC address to forward or block it. For a MAC address to be set in the forwarding state, all enabled user modules must unanimously agree on allowing the MAC address to forward. If only one chooses to block it, it will be blocked until that user module decides otherwise.

The status page is divided into two sections - one with a legend of user modules and one with the actual port status.

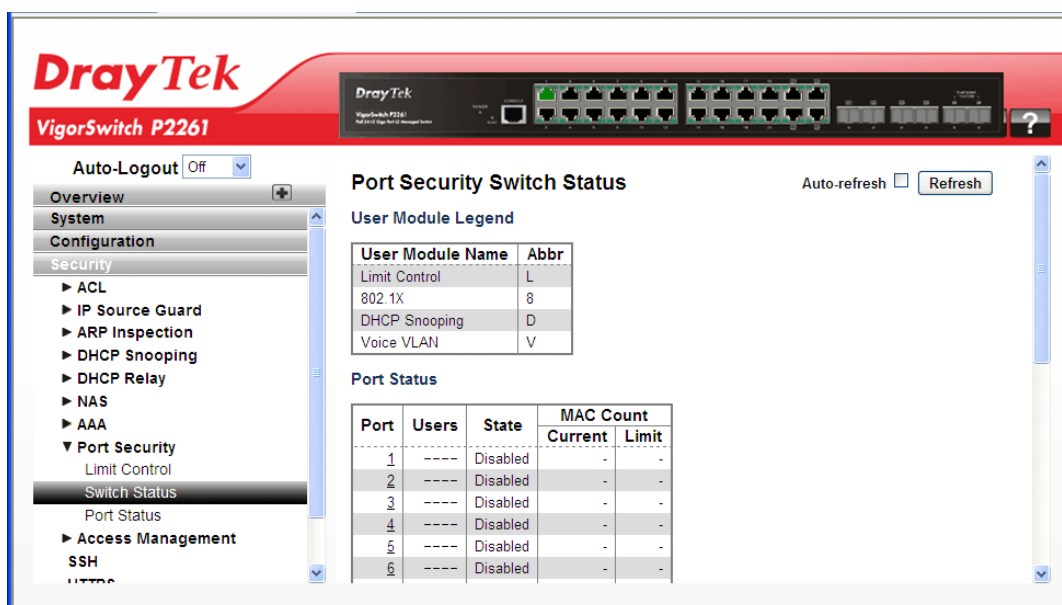

### Parameters description:

#### User Module Legend

User Module Name	The full name of a module that may request Port Security services.
Abbr	A one-letter abbreviation of the user module. This is used in the Users column in the port status table.

#### Port Status

Port	The port number for which the status applies. Click the port number to see the status for this particular port.
Users	Each of the user modules has a column that shows whether that module has enabled Port Security or not. A '-' means that the corresponding user module is not enabled, whereas a letter indicates that the user module abbreviated by that letter (see Abbr) has enabled port security.
State	Shows the current state of the port. It can take one of four values: <i>Disabled:</i> No user modules are currently using the Port Security service. <i>Ready:</i> The Port Security service is in use by at least one user module, and is awaiting frames from unknown MAC addresses to arrive. <i>Limit Reached:</i> The Port Security service is enabled by at least the Limit Control user module, and that module has indicated that the limit is reached and no more MAC addresses should be taken in. <i>Shutdown:</i> The Port Security service is enabled by at least the Limit Control user module, and that module has indicated that the limit is exceeded. No MAC addresses can be learned on the port until it is administratively re-opened on the Limit Control configuration Web-page.
MAC Count (Current, Limit)	The two columns indicate the number of currently learned

Limit)	<p>MAC addresses (forwarding as well as blocked) and the maximum number of MAC addresses that can be learned on the port, respectively.</p> <p>If no user modules are enabled on the port, the Current column will show a dash (-).</p> <p>If the Limit Control user module is not enabled on the port, the Limit column will show a dash (-).</p> <p>Indicates the number of currently learned MAC addresses (forwarding as well as blocked) on the port. If no user modules are enabled on the port, a dash (-) will be shown.</p>
Auto refresh	The simple counts will be refreshed automatically on the UI screen.
Refresh	The simple counts will be refreshed manually when user use mouse to click on “Refresh” button.

### 2.4.23 Port Security – Port Status

**Function name:**

Port Security – Port Status

**Function description:**

The function shows the MAC addresses secured by the Port Security module. Port Security is a module with no direct configuration. Configuration comes indirectly from other modules - the user modules. When a user module has enabled port security on a port, the port is set-up for software-based learning. In this mode, frames from unknown MAC addresses are passed on to the port security module, which in turn asks all user modules whether to allow this new MAC address to forward or block it. For a MAC address to be set in the forwarding state, all enabled user modules must unanimously agree on allowing the MAC address to forward. If only one chooses to block it, it will be blocked until that user module decides otherwise.

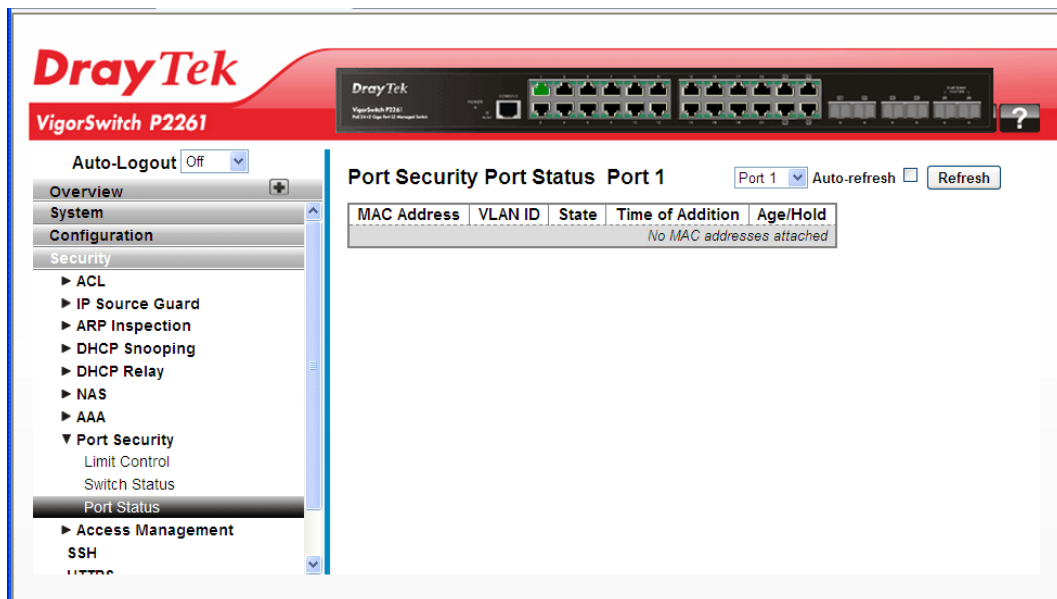

**Parameters description:**

MAC Address & VLAN	The MAC address and VLAN ID that is seen on this port. If
--------------------	---

ID	no MAC addresses are learned, a single row stating "No MAC addresses attached" is displayed.
State	Indicates whether the corresponding MAC address is blocked or forwarding. In the blocked state, it will not be allowed to transmit or receive traffic.
Time of Addition	Shows the date and time when this MAC address was first seen on the port.
Age/Hold	<p>If at least one user module has decided to block this MAC address, it will stay in the blocked state until the hold time (measured in seconds) expires. If all user modules have decided to allow this MAC address to forward, and aging is enabled, the Port Security module will periodically check that this MAC address still forwards traffic. If the age period (measured in seconds) expires and no frames have been seen, the MAC address will be removed from the MAC table. Otherwise a new age period will begin.</p> <p>If aging is disabled or a user module has decided to hold the MAC address indefinitely, a dash (-) will be shown.</p>
Auto refresh	The simple counts will be refreshed automatically on the UI screen.
Refresh	The simple counts will be refreshed manually when user use mouse to click on "Refresh" button.

## 2.4.24 Access Management – General Setup

### Function name:

Access Management – General Setup

### Function description:

The function is used to configure access management table of the Switch including HTTP/HTTPS, SNMP, and TELNET/SSH. You can manage the Switch over an Ethernet LAN, or over the Internet.

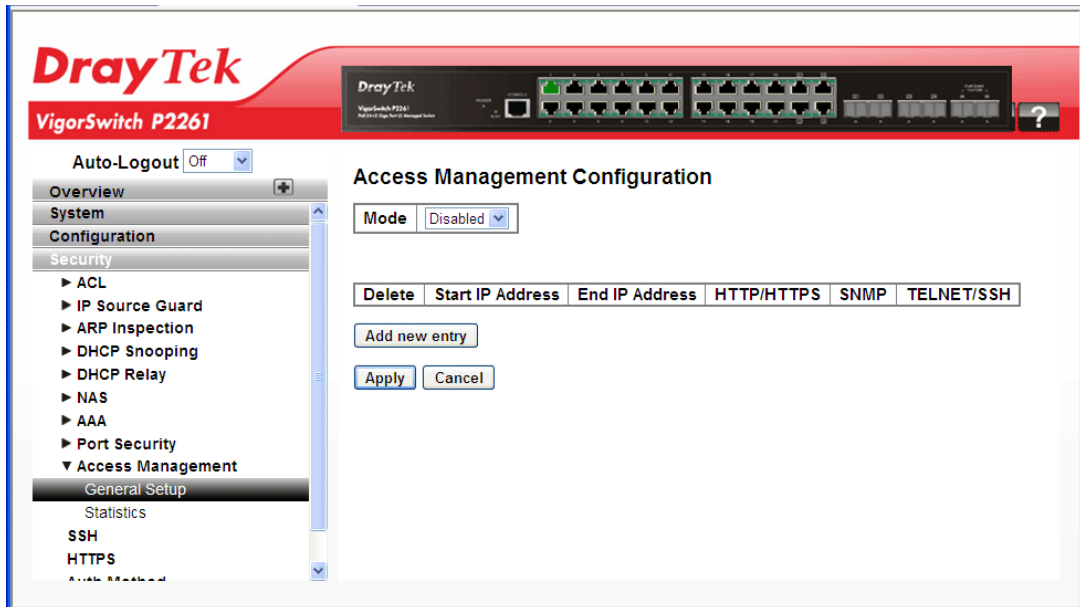

### Parameters description:

Mode	Indicates the access management mode operation. Possible modes are: <i>Enabled</i> : Enable access management mode operation. <i>Disabled</i> : Disable access management mode operation.
Delete	Check to delete the entry.
Start IP address	Indicates the start IP address for the access management entry.
End IP address	Indicates the end IP address for the access management entry.
HTTP/HTTPS	Indicates that the host can access the switch from HTTP/HTTPS interface if the host IP address matches the IP address range provided in the entry.
SNMP	Indicates that the host can access the switch from SNMP interface if the host IP address matches the IP address range provided in the entry.
TELNET/SSH	Indicates that the host can access the switch from TELNET/SSH interface if the host IP address matches the IP address range provided in the entry.
Add new entry	Create a new entry.

**Access Management Configuration**

Mode Disabled

Delete	Start IP Address	End IP Address
<input type="button" value="Delete"/>	0.0.0.0	0.0.0.0

After finished the above settings, click **Apply** to save the configuration. The settings will take effect.

## 2.4.25 Access Management – Statistics

**Function name:**

Access Management – Statistics

**Function description:**

The function shows you a detailed statistics of the Access Management including HTTP, HTTPS, SSH, TELNET and SSH.

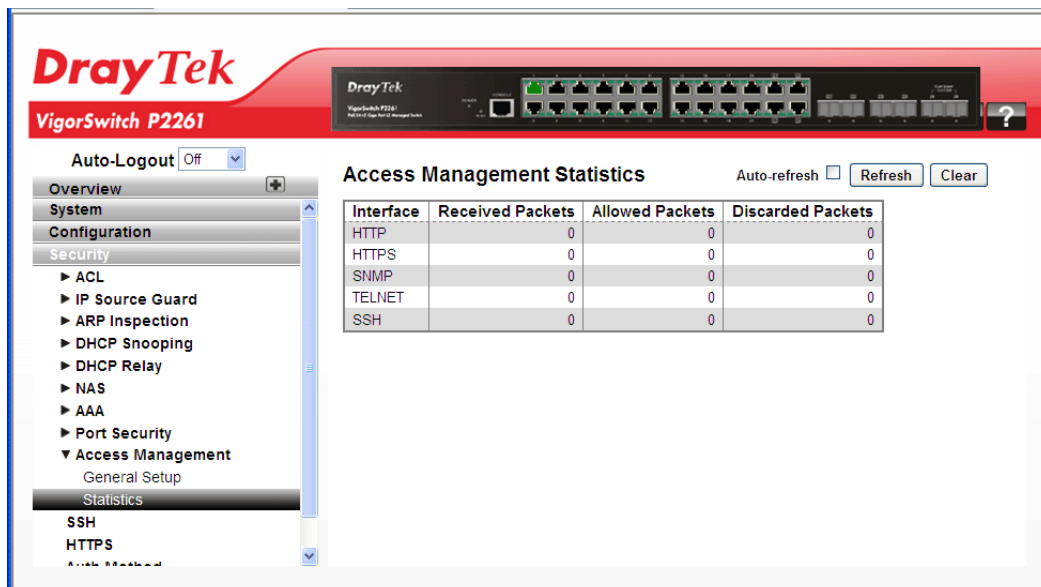

**Parameters description:**

Interface	The interface type through which the remote host can access the switch.
Received Packets	Number of received packets from the interface when access management mode is enabled.
Allowed Packets	Number of allowed packets from the interface when access management mode is enabled.
Discarded Packets	Number of discarded packets from the interface when access management mode is enabled.
Auto refresh	The simple counts will be refreshed automatically on the UI screen.
Refresh	The simple counts will be refreshed manually when user use mouse to click on “Refresh” button.



Clear	The simple counts will be reset to zero when user use mouse to click on “Clear” button.
-------	---

## 2.4.26 SSH

### Function name:

SSH

### Function description:

The function uses SSH (Secure SHell) to securely access the Switch. SSH is a secure communication protocol that combines authentication and data encryption to provide secure encrypted communication.

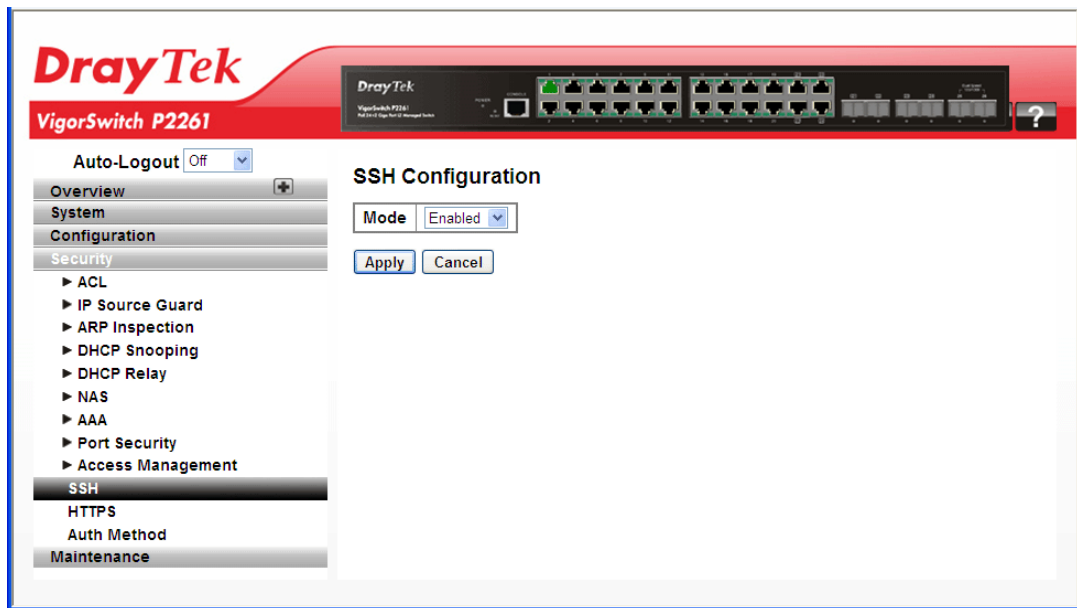

### Parameters description:

Mode	Indicates the SSH mode operation. Possible modes are: <i>Enabled</i> : Enable SSH mode operation. <i>Disabled</i> : Disable SSH mode operation.
------	---

After finished the above settings, click **Apply** to save the configuration. The settings will take effect.

## 2.4.27 HTTPS

**Function name:**

HTTP

**Function description:**

The function uses HTTPS to securely access the Switch. HTTPS is a secure communication protocol that combines authentication and data encryption to provide secure encrypted communication via the browser.

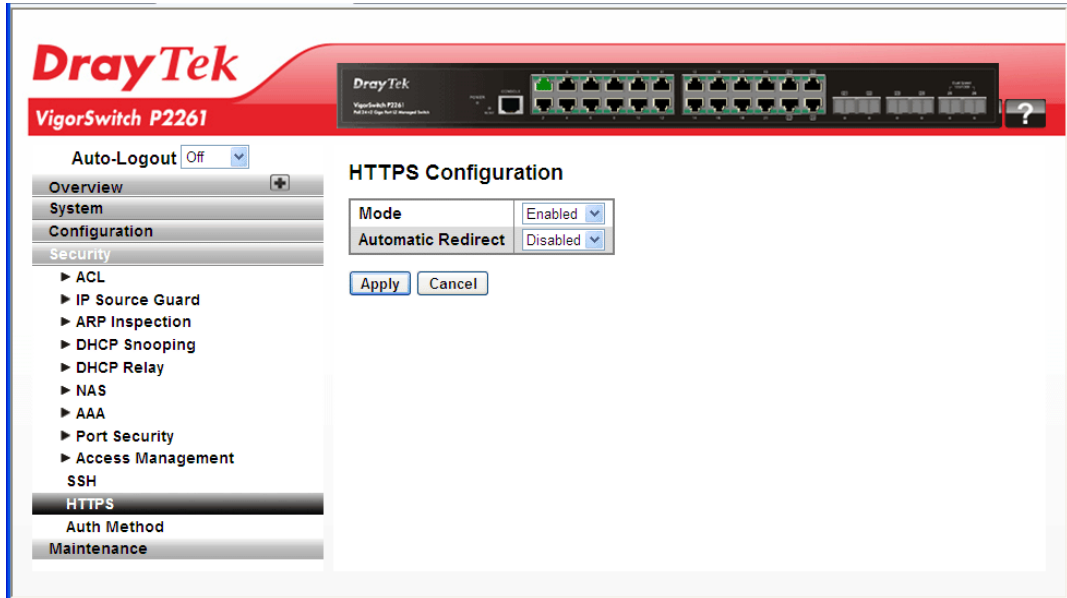

**Parameters description:**

Mode	Indicates the HTTPS mode operation. Possible modes are: <i>Enabled</i> : Enable HTTPS mode operation. <i>Disabled</i> : Disable HTTPS mode operation.
Automatic Redirect	Indicates the HTTPS redirect mode operation. Automatically redirect web browser to HTTPS when HTTPS mode is enabled. Possible modes are: <i>Enabled</i> : Enable HTTPS redirect mode operation. <i>Disabled</i> : Disable HTTPS redirect mode operation.

After finished the above settings, click **Apply** to save the configuration. The settings will take effect.

## 2.4.28 Auth Method

### Function name:

Auth Method

### Function description:

The function is used to configure a user with authenticated when he logs into the switch via one of the management client interfaces.

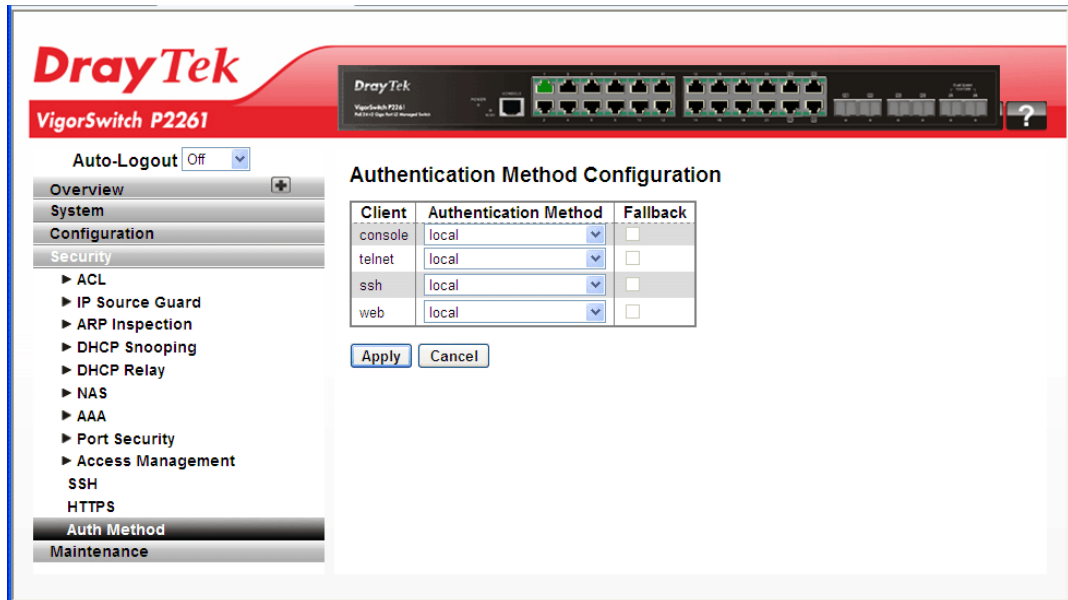

### Parameters description:

Client	The management client for which the configuration below applies.
Authentication Method	Authentication Method can be set to one of the following values: <i>none</i> : Authentication is disabled and login is not possible. <i>local</i> : Use the local user database on the switch stack for authentication. <i>RADIUS</i> : Use a remote RADIUS server for authentication. <i>TACACS+</i> : Use a remote TACACS+ server for authentication.
Fallback	Enable fallback to local authentication by checking this box. If none of the configured authentication servers are alive, the local user database is used for authentication. This is only possible if the Authentication Method is set to a value other than 'none' or 'local'.

After finished the above settings, click **Apply** to save the configuration. The settings will take effect.

## 2.5 Maintenance

This section describes all of the switch Maintenance configuration tasks to enhance the performance of local network including Restart Device, Firmware upgrade, Save/Restore, Import/Export, and Diagnostics.

### 2.5.1 Restart Device

**Function name:**

Restart Device

**Function description:**

The function is used to restart switch for any maintenance needs. Any configuration files or scripts that you saved in the switch should still be available afterwards.

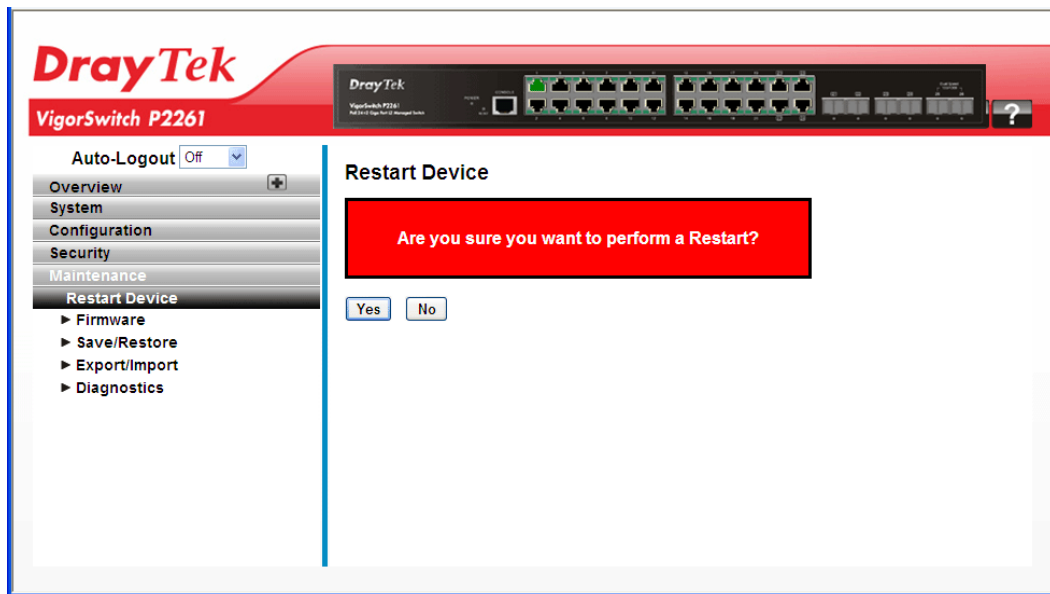

Click **Yes** to restart the device.

## 2.5.2 Firmware – Firmware Upgrade

**Function name:**

Firmware – Firmware Upgrade

**Function description:**

The function is used to upgrade the Firmware. The Switch can be enhanced with more value-added functions by installing firmware upgrades.

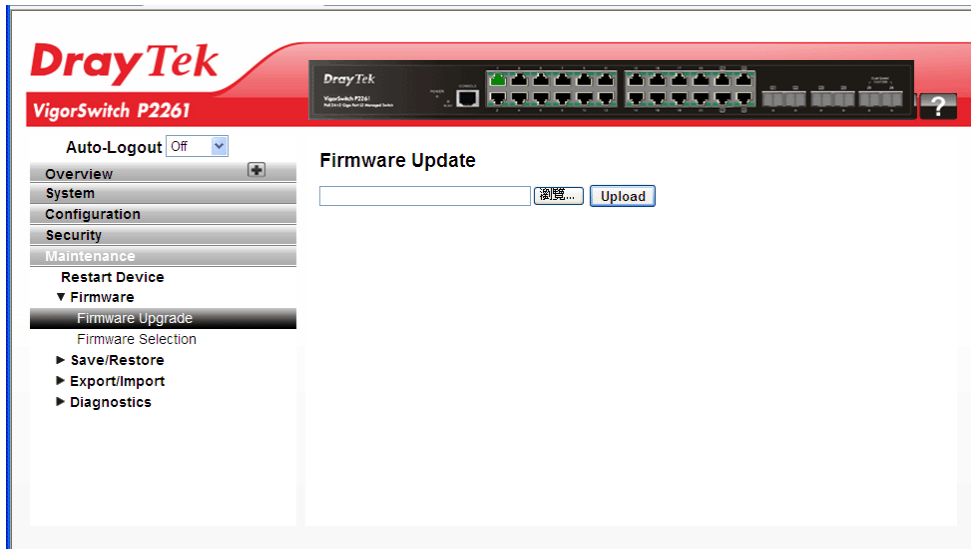

Click **Browser...** to select firmware in you device and click **Upload**.

Warning: While the firmware is being updated, web access appears to be defunct. The front LED flashes Green/Off with a frequency of 10 Hz while the firmware update is in progress. Do not restart or power off the device at this time or the switch may fail to function afterwards.

## 2.5.3 Firmware – Firmware Selection

### Function name:

Firmware – Firmware Selection

### Function description:

Due to the switch supports Dual image for firmware redundancy purpose. You can select what firmware image for your device start firmware or operating firmware. This page provides information about the active and alternate (backup) firmware images in the device, and allows you to revert to the alternate image.

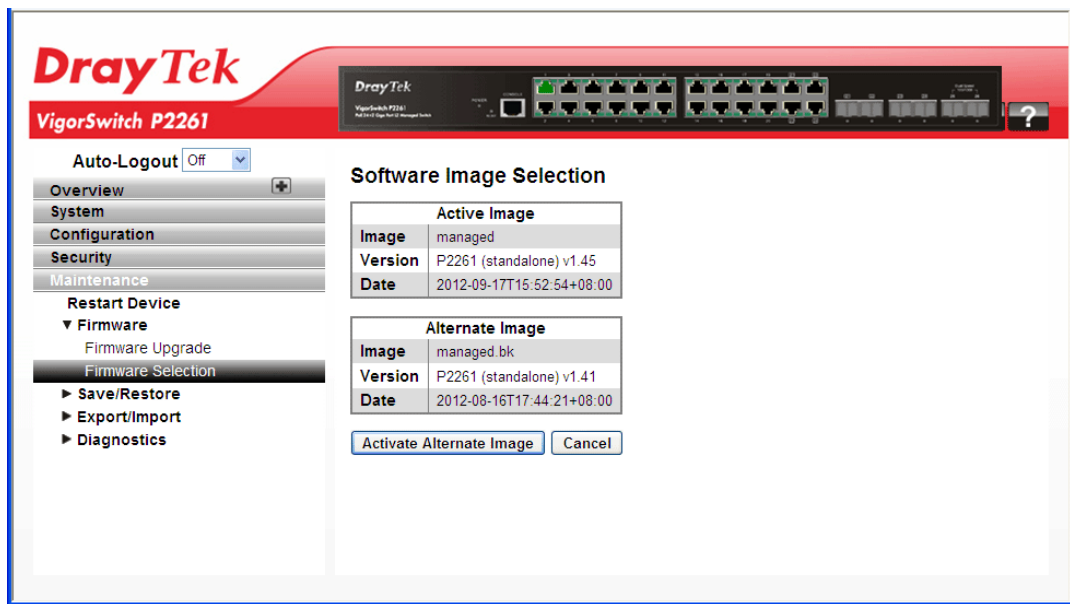

### Parameters description:

Image	The flash index name of the firmware image. The name of primary (preferred) image is <i>image</i> , the alternate image is named <i>image.bk</i> .
Version	The version of the firmware image.
Date	The date where the firmware was produced.
Activate Alternate Image	Click to use the alternate image. This button may be disabled depending on system state.

#### Note:

In case the active firmware image is the alternate image, only the "Active Image" table is shown. In this case, the Activate Alternate Image button is also disabled.

If the alternate image is active (due to a corruption of the primary image or by manual intervention), uploading a new firmware image to the device will automatically use the primary image slot and activate this.

The firmware version and date information may be empty for older firmware releases. This does not constitute an error.

## 2.5.4 Save/Restore – Factory Defaults

**Function name:**

Save/Restore – Factory Defaults

**Function description:**

The function is used to save and restore the Switch configuration including reset to Factory Defaults, Save Start, Save Users, Restore Users for any maintenance needs. Any configuration files or scripts will recover to factory default values.

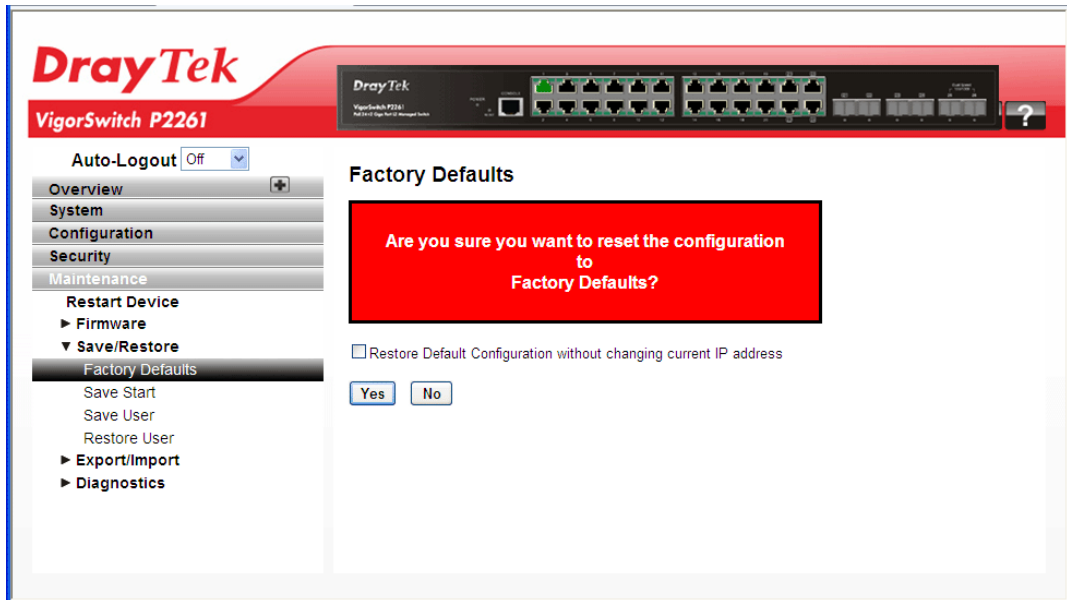

Click **Yes** to reset the Switch configuration to Factory Defaults. Only the IP configuration is retained.

## 2.5.5 Save/Restore – Save Start

**Function name:**

Save/Restore – Save Start

**Function description:**

The function is used to save the Switch Start configuration.

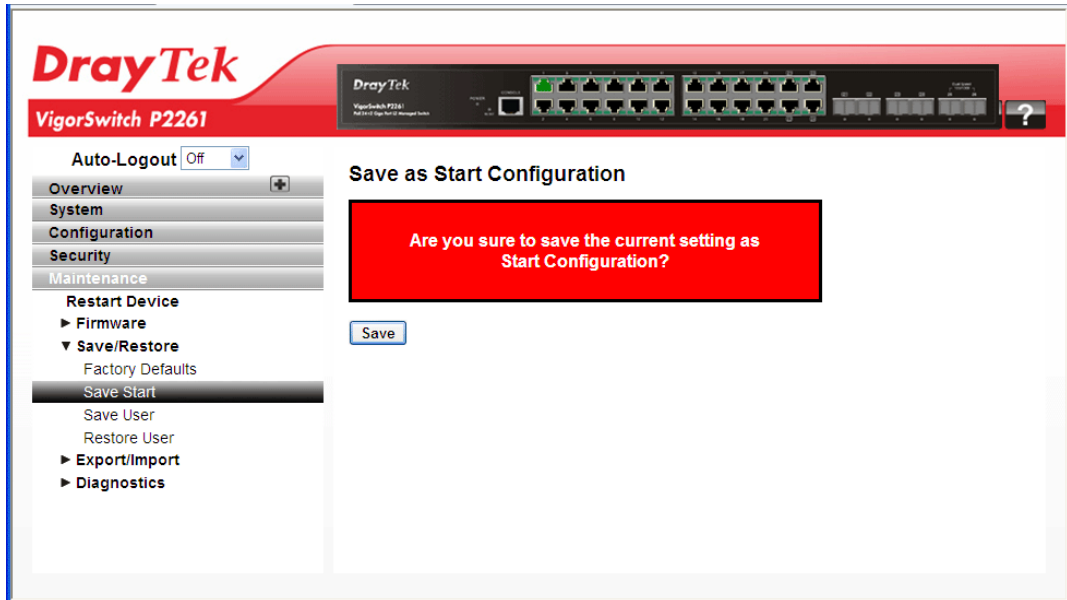

Click **Save** to perform the work. You can save/view or load the switch configuration. The configuration file is in XML format with a hierarchy of tags.



## 2.5.6 Save/Restore – Save User

**Function name:**

Save/Restore – Save User

**Function description:**

The function is used to save users information. Any current configuration files will be saved as XML format.

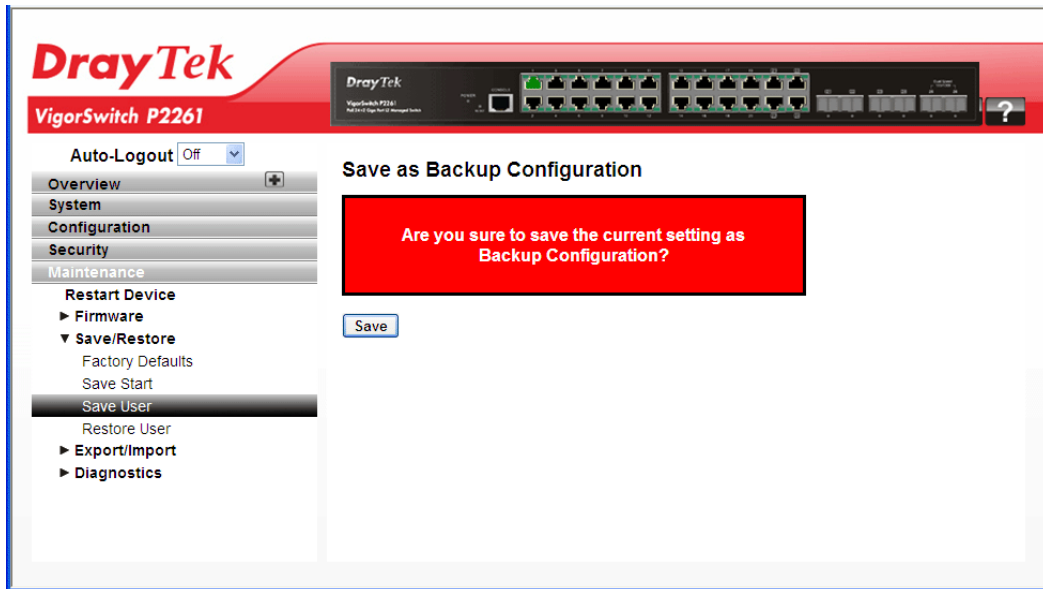

Click **Save** to perform the work. You can save/view or load the switch configuration. The configuration file is in XML format with a hierarchy of tags.

## 2.5.7 Save/Restore – Restore User

**Function name:**

Save/Restore – Restore User

**Function description:**

The function is used to restore user information back to the switch. Any current configuration files will be restored via XML format.

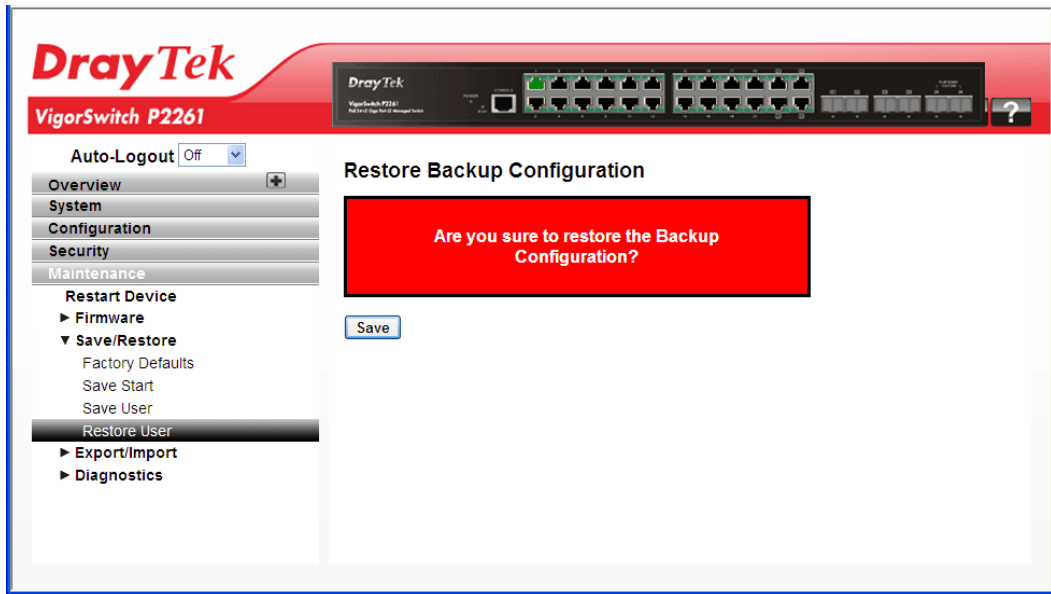

Click **Save** to perform the work. You can save/view or load the switch configuration. The configuration file is in XML format with a hierarchy of tags.

## 2.5.8 Export/Import – Export Config

**Function name:**

Export/Import – Export Config

**Function description:**

The function is used to export the Switch configuration. Any current configuration files will be exported as XML format.

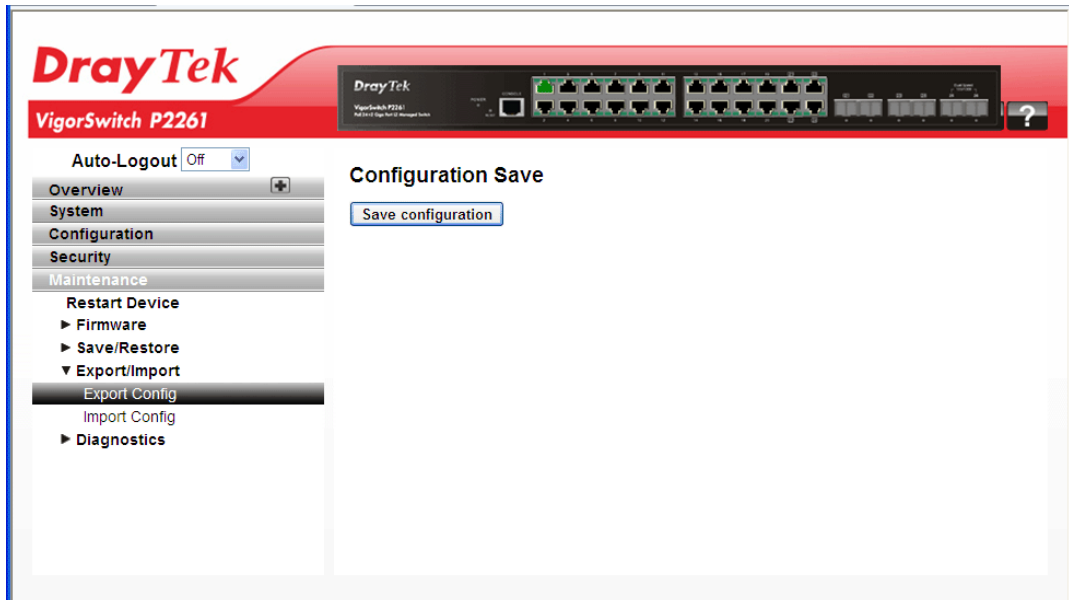

Click **Save configuration** to perform the work. You can save/view or load the switch configuration. The configuration file is in XML format with a hierarchy of tags.

## 2.5.9 Export/Import – Import Config

**Function name:**

Export/Import – Import Config

**Function description:**

The function is used to import the Switch Configuration for maintenance needs. Any current configuration files will be exported as XML format.

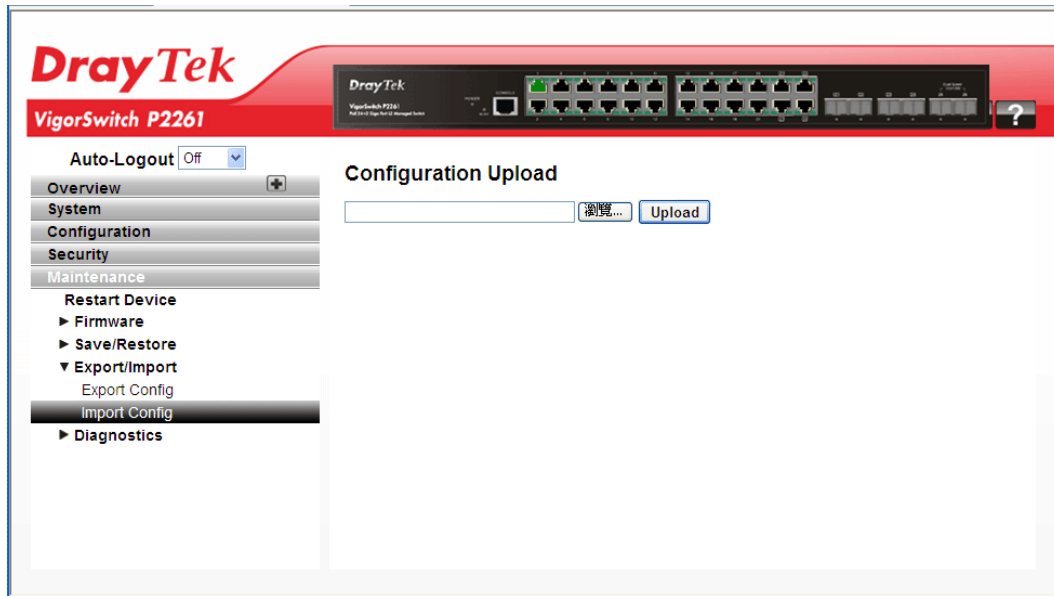

Click **Browser...** to select firmware in you device and click **Upload**. You can save/view or load the switch configuration. The configuration file is in XML format with a hierarchy of tags.

## 2.5.10 Diagnostics – Ping

Diagnostics is used to provide a set of basic system diagnosis. It let users know whether the system is health or needs to be fixed. The basic system check includes ICMP Ping, ICMPv6, and VeriPHY Cable Diagnostics.

### Function name:

Diagnostics – Ping

### Function description:

The function allows you to issue ICMP PING packets to troubleshoot IPv6 connectivity issues.

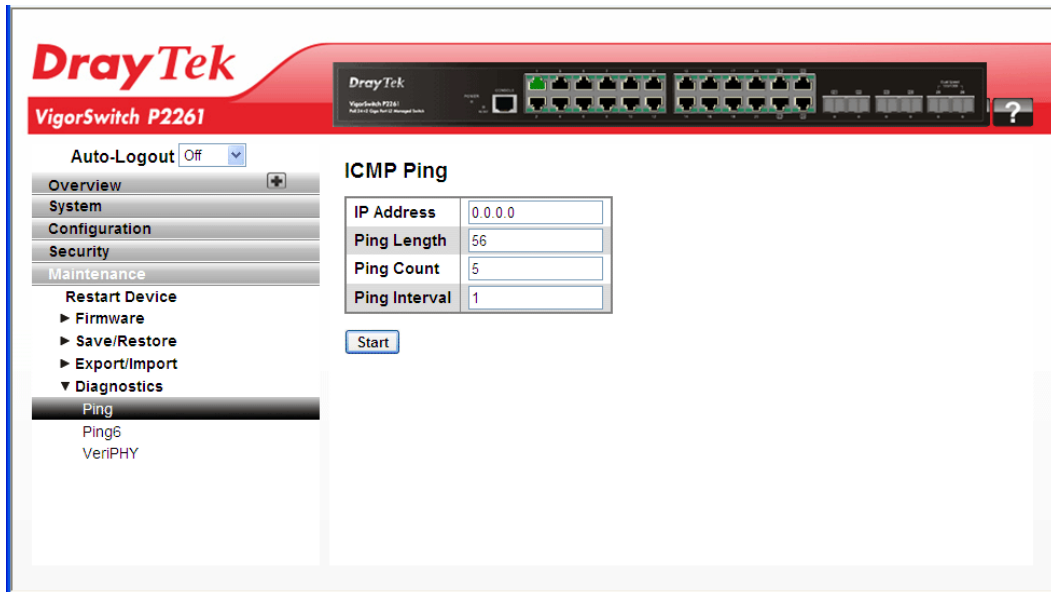

### Parameters description:

IP Address	Set the IP Address of device what you want to ping it.
<b>Ping Length</b>	The payload size of the ICMP packet. Values range from 2 bytes to 1452 bytes.
<b>Ping Count</b>	The count of the ICMP packet. Values range from 1 time to 60 times.
<b>Ping Interval</b>	The interval of the ICMP packet. Values range from 0 second to 30 seconds.
Start	Click the “Start” button then the switch will start to ping the device using ICMP packet size what set on the switch.

After you click Start, 5 ICMP packets are transmitted and the sequence number & roundtrip time are displayed upon reception of a reply. The page refreshes automatically until responses to all packets are received, or until a timeout occurs.

```
PING6 server::10.10.132.20
```

```
64 bytes from::10.10.132.20: icmp_seq=0, time=0ms
```

```
64 bytes from::10.10.132.20: icmp_seq=1, time=0ms
```

```
64 bytes from::10.10.132.20: icmp_seq=2, time=0ms
```

```
64 bytes from::10.10.132.20: icmp_seq=3, time=0ms
```

```
64 bytes from::10.10.132.20: icmp_seq=4, time=0ms
```

```
Sent 5 packets, received 5 OK, 0 bad
```

## 2.5.11 Diagnostics – Ping6

**Function name:**

Diagnostics – Ping6

**Function description:**

The function allows you to issue ICMPv6 PING packets to troubleshoot IPv6 connectivity issues.

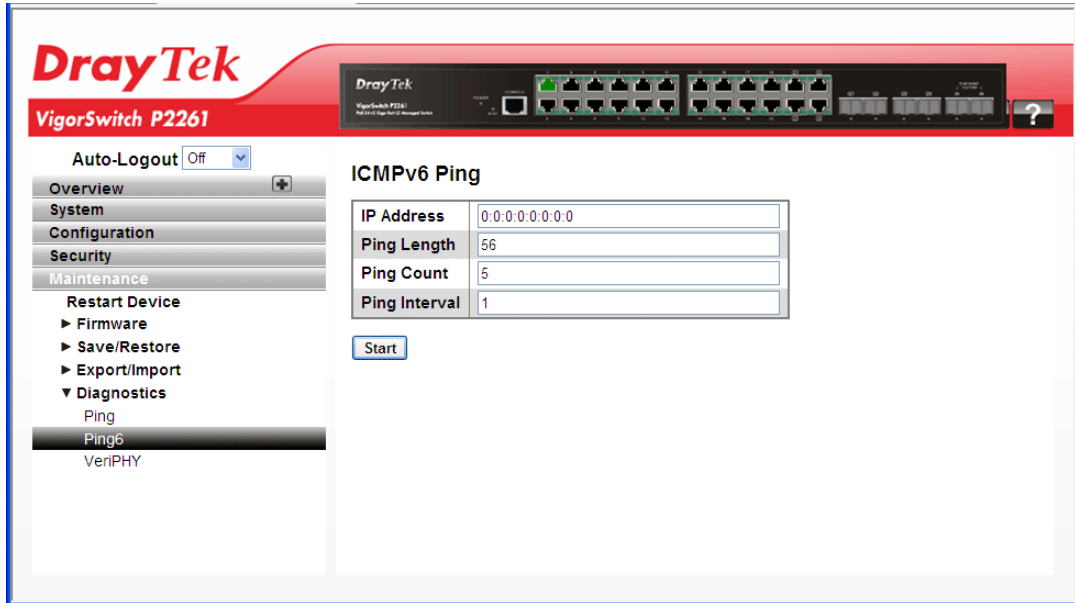

**Parameters description:**

IP Address	The destination IP Address with IPv6.
<b>Ping Length</b>	The payload size of the ICMP packet. Values range from 2 bytes to 1452 bytes.
<b>Ping Count</b>	The count of the ICMP packet. Values range from 1 time to 60 times.
<b>Ping Interval</b>	The interval of the ICMP packet. Values range from 0 second to 30 seconds.
Start	Click the “Start” button then the switch will start to ping the device using ICMPv6 packet size what set on the switch.

After you click Start, 5 ICMPv6 packets are transmitted, and the sequence number and roundtrip time are displayed upon reception of a reply. The page refreshes automatically until responses to all packets are received, or until a timeout occurs.

PING server 10.10.132.20

64 bytes from 10.10.132.20: icmp\_seq=0, time=0ms

64 bytes from 10.10.132.20: icmp\_seq=1, time=0ms

64 bytes from 10.10.132.20: icmp\_seq=2, time=0ms

64 bytes from 10.10.132.20: icmp\_seq=3, time=0ms

64 bytes from 10.10.132.20: icmp\_seq=4, time=0ms

Sent 5 packets, received 5 OK, 0 bad

## 2.5.12 Diagnostics – VeriPHY

### Function name:

Diagnostics – VeriPHY

### Function description:

The function is used for running the VeriPHY Cable Diagnostics. Press to run the diagnostics. This will take approximately 5 seconds. If all ports are selected, this can take approximately 15 seconds. When completed, the page refreshes automatically, and you can view the cable diagnostics results in the cable status table. Note that VeriPHY is only accurate for cables of length 7 -140 meters. 10 and 100 Mbps ports will be linked down while running VeriPHY. Therefore, running VeriPHY on a 10 or 100 Mbps management port will cause the switch to stop responding until VeriPHY is complete.

The screenshot shows the DrayTek VigorSwitch P2261 web interface. The main heading is 'VeriPHY Cable Diagnostics'. Below the heading, there is a 'Port' dropdown menu set to 'All' and a 'Start' button. A table titled 'Cable Status' is displayed, with the following columns: Port, Pair A, Length A, Pair B, Length B, Pair C, Length C, Pair D, and Length D. The table contains 10 rows, one for each port, with dashes in the Pair and Length columns.

Port	Pair A	Length A	Pair B	Length B	Pair C	Length C	Pair D	Length D
1	--	--	--	--	--	--	--	--
2	--	--	--	--	--	--	--	--
3	--	--	--	--	--	--	--	--
4	--	--	--	--	--	--	--	--
5	--	--	--	--	--	--	--	--
6	--	--	--	--	--	--	--	--
7	--	--	--	--	--	--	--	--
8	--	--	--	--	--	--	--	--
9	--	--	--	--	--	--	--	--
10	--	--	--	--	--	--	--	--

### Parameters description:

Port	The port where you are requesting VeriPHY Cable Diagnostics.
Cable Status	Port: Port number. Pair: The status of the cable pair. Length: The length (in meters) of the cable pair.

After finished the above settings, click **Start** to perform the Ping job.

This page is left blank.



# Chapter 3: Trouble Shooting

This section will guide you to solve abnormal situations if you cannot access into the Internet after installing the device and finishing the web configuration. Please follow sections below to check your basic installation status stage by stage.

- Checking if the hardware status is OK or not.
- Checking if the network connection settings on your computer are OK or not.
- Pinging the device from your computer.
- Checking if the ISP settings are OK or not.
- Backing to factory default setting if necessary.

If all above stages are done and the device still cannot run normally, it is the time for you to contact your dealer for advanced help.

## 3.1 Resolving No Link Condition

The possible causes for a no link LED status are as follows:

- The attached device is not powered on
- The cable may not be the correct type or is faulty
- The installed building premise cable is faulty
- The port may be faulty

## 3.2 Q & A

### **1. Computer A can connect to Computer B, but cannot connect to Computer C through the Managed Switch.**

- The network device of Computer C may fail to work. Please check the link/act status of Computer C on the LED indicator. Try another network device on this connection.
- The network configuration of Computer C may be something wrong. Please verify the network configuration on Computer C.

### **2. The uplink connection function fails to work.**

- The connection ports on another must be connection ports. Please check if connection ports are used on that Managed Switch.
- Please check the uplink setup of the Managed Switch to verify the uplink function is enabled.

### **3. The console interface cannot appear on the console port connection.**

- The COM port default parameters are [Baud Rate: 115200, Data Bits: 8, Parity Bits: None, Stop Bit: A, Flow Control: None]. Please check the COM port property in the terminal program. And if the parameters are changed, please set the COM configuration to the new setting.

- Check the RS-232 cable is connected well on the console port of the Managed Switch and COM port of PC.
- Check if the COM of the PC is enabled.

#### **4. How to configure the Managed Switch?**

The “Hyperterm” is the terminal program in Win95/98/NT. Users can also use any other terminal programs in Linux/Unix to configure the Managed Switch. Please refer to the user guide of that terminal program. But the COM port parameters (baud rate/ data bits/ parity bits/ flow control) must be the same as the setting of the console port of the Managed Switch.